

SEQUENCE® *Primer Champion*

■ Primer Champion Model 3700PRM21

The all in one! The Primer Champion series integrates a basket-type pre-filter and self-priming capabilities into one efficient package for trouble free operation. Since an internal diffuser allows for displacement of trapped air, this type of pump will continue to move water even when there is some air in the line. The integrated strainer basket on all the primer units helps protect the internal rotating parts of the pump from damage due to external debris being pulled into the pump, i.e. branches, leaves, etc. The simple cover allows for quick cleaning and replacement.

Because the unit can operate for short periods of time without full water flow, it provides a small cushion of comfort to the owners of those systems where the water level drops below the intake point. Motor is totally-enclosed, fan-cooled for durability. 3 year limited warranty. Made in the USA. **115V or 230V. 8-foot 115V cordset included.**

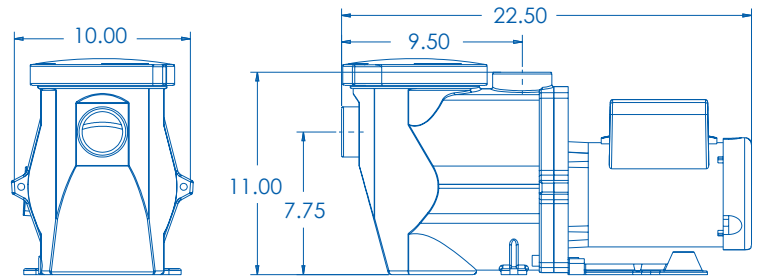
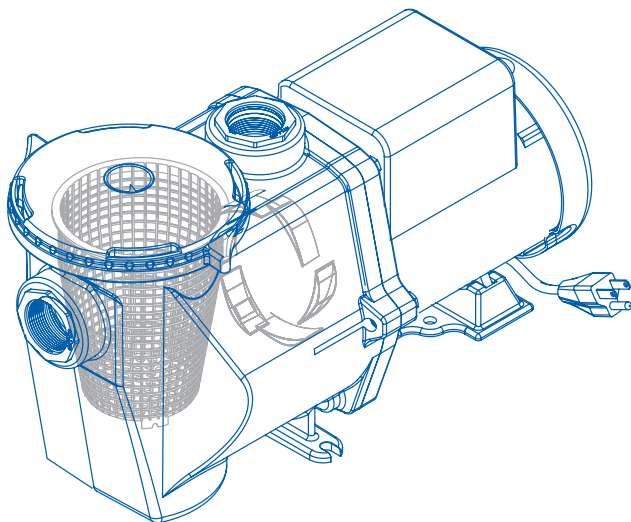

*Dimensions and illustrations are approximate and for reference only

Flow At Total Dynamic Head

Model	Max Flow GPH	Max Head Feet	Max Power Watts	Max Current Amps	Flow At Total Dynamic Head					Voltage	Motor Enclosure	
					Flow	4'	8'	12'	16'			20'
3700PRM21	3700	21	228	2.76	GPM	49	42	34	23	4	115	TEFC
					GPH	2940	2520	2040	1380	240		

Sustainable, Efficient

© 2009 SEQUENCE PUMPS A DIVISION OF MDM INC.



SEQUENCE 3700PRM21 (Low-Speed)

