

SEQUENCE® 4000

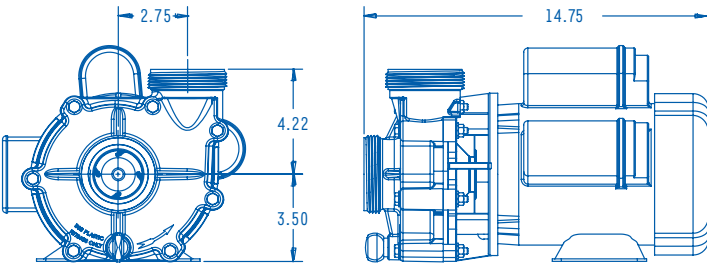

■ 4000 Model 5000SEQ20

Introducing the NEW Sequence® 4000. The new expansive design will meet today's increased market demand for performance on all levels. Peak performance of 4980 Gallons Per Hour while only requiring 263 Watts! Every Sequence® 4000 model is supplied complete with 2" FNPT and buttress thread ports and unions for ease of use. 3 year limited warranty. Made in USA. **Supplied with an 8-foot, 115V cordset.**



*Dimensions and illustrations are approximate and for reference only.

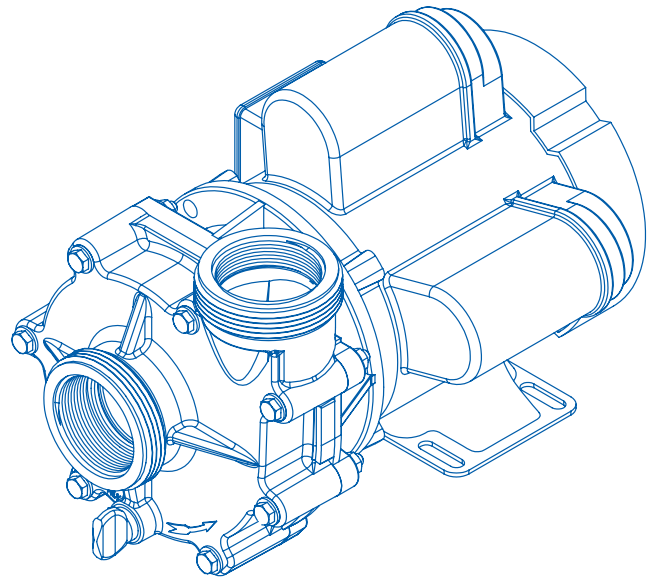

Flow At Total Dynamic Head

Model	Max Flow GPH	Max Head Feet	Max Power Watts	Max Current Amps	Flow At Total Dynamic Head					Voltage	Motor Enclosure	
					Flow	4'	8'	12'	16'			20'
5000SEQ20	4980	20.2	263	2.3	GPM	75	64	52	36	2	115	TEFC
					GPH	4500	3840	3120	2160	120		

Sustainable, Efficient ©2010 SEQUENCE® PUMPS A DIVISION OF MDM INC.



SEQUENCE #5 IMPELLER 5000SEQ20

