

FIVE YEARS LIMITED WARRANTY BP CEILINGS

(BP RESIDENTIAL CEILINGS CONSIST OF CEILING CLASSICS TILES AND PANELS, MINERALITE PANELS, SPECIAL VALUE PANELS AND FIBER GLASS PANELS)

WARRANTY

Building Products of Canada Corp. warrants its BP Ceilings to be free from manufacturing defects for a period of five years from the date of purchase, subject to the conditions, limitations and exclusions set out below.

WARRANTY PERIOD

The warranty period for BP Ceilings is five years from the date of purchase of the product (dealer's invoice is proof of purchase date).

LIABILITY

If a warranted defect occurs during the warranty period, Building Products of Canada Corp. will supply new material of the same or similar design and quality to replace the defective material which supply will be the exclusive remedy under this warranty or any implied warranty.

LIMITATIONS

1. This warranty covers BP Ceilings applied in residential buildings, in accordance with the published Building Products of Canada Corp. application procedures. Application must be indoors where the relative humidity is not more than 70% and the temperature not more than 27 °C (80 °F). Improper use, i.e. outdoor application or application to surfaces other than ceilings is not covered.
2. The maximum liability will not exceed the original cost of the material replaced.
3. Application/labor costs for the removal of product found defective and for the installation of replacement product are not covered.
4. This warranty does not cover the cost or replacement of a suspension system.
5. Building Products of Canada Corp. will not be liable for material improperly installed or for damages caused by the attachment of any accessories or caused by an act of God or force majeure or any misuse or neglect.
6. Normal wear and tear or shade changes caused, for example, but without limitation, by exposure to smoke, fumes, water leakage or abuse are not covered.

CONSEQUENTIAL OR INCIDENTAL DAMAGE

In no event shall Building Products of Canada Corp. be responsible or liable for consequential or incidental damages of any kind, including any economic loss, damages to the building, its contents or any persons therein.

TRANSFERABILITY

This warranty is not transferable to a new owner of the building.

EXTENT OF WARRANTIES

This warranty is expressly in lieu of and excludes all other warranties, liabilities, representations or obligations of Building Products of Canada Corp., oral or written, expressed or implied. No implied warranty shall extend beyond the five years warranty period written herein. No representative of Building Products of Canada Corp., its distributors or dealers is authorized to change or modify this warranty. This warranty gives you specific legal rights. You may have different rights which may vary from province to province according to applicable legislation. This warranty does not exclude or limit those rights but shall run concurrently with them.

CLAIMS

Claim must be made in writing to the retailer who sold the product, describing problem in detail. If the retailer no longer exists or if you are not satisfied with the reply, contact us giving the dealer's name, copy of the invoice and description of the problem. Send to:

Building products of Canada Corp.
9510, St. Patrick St.
LaSalle, Québec H8R 1R9

Building Products of Canada Corp. shall be permitted a reasonable opportunity to examine and test the product to determine if a defect exists.

Dealer :

PRINTED IN CANADA 5071 2013-09

HOW TO INSTALL A TILE CEILING

PLANNING AND CALCULATING YOUR MATERIALS

For proper tile installation, we recommend you first draft a plan of the new ceiling.

- 1) Measure the length and width of your room and draw its perimeter on the grid sheet included in this pamphlet. Remember to include wall irregularities such as protrusions, recesses, beams and stairwells.

Important information to remember

For a perfect final appearance, the size of the border tiles must be the same for each side of the room and more than half the size of a standard tile.

- 2) To determine the width of the border tiles, use Table B as follows: in the 11' 7" of sketch A, take the value inferior to 1 foot, i.e. 7" and refer to Table B right below that measure to find that the width of the border tiles should be 9 1/2". Apply the same formula in the room's opposite direction, i.e. 3" to obtain the measurement for the other border tiles: 7 1/2".

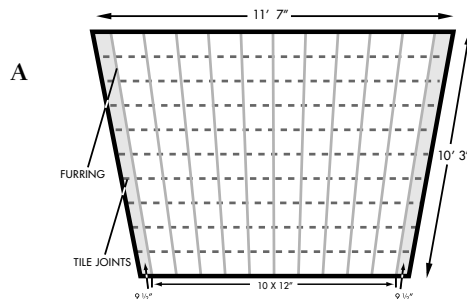

B

If room measure is this many inches over exact number of feet...	1	2	3	4	5	6	7	8	9	10	11
Border tile width is...	6 1/2	7	7 1/2	8	8 1/2	9	9 1/2	10	10 1/2	11	11 1/2

Using your room dimensions and Table B, determine the width of your border tiles and trace each side's first two furrings on your plan. The size of the border tiles running in the direction opposite that of the joists, gives you the position of each side's first two furrings.

You can now trace the position of the remaining furrings, i.e. 12" center-to-center from one another, and then, in the opposite direction, draw the tile joints also 12" center-to-center. We recommend you use different colors or thicknesses so that you can distinguish the furrings from the joints as you refer to your plan.

- 3) At this stage, you can calculate the materials you will need (furrings, tiles, wall angle flanges or moldings).

INSTALLING YOUR NEW BP CEILING

STEP 1

Begin by nailing a furring strip perpendicular to ceiling joists, flush against the two opposing walls. The strips will act as a nailing base for the finishing trim. The next furring strip should be installed at a distance equivalent to the width of the border tile.

Continue to nail furring strips across the ceiling parallel to the first strip at 12" centers. Remember that your finished ceiling will only be as level as the furring strips. Use string lines to ensure the strips are level. If need be, insert wood shims between the furring strips and joists to make them level. Butt furring strips under joists and double nail each end. Stagger butt joints to avoid always falling on the same joist.

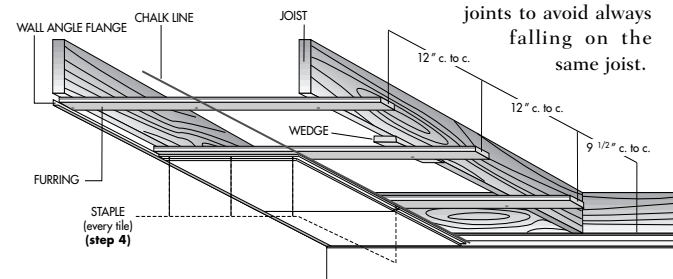

STEP 2

Begin tile application (perpendicular to ceiling joists) at one corner of the room. Cut the corner tile to the pre-determined size by cutting off the side opposite the nailing flange. Add 1/2" to compensate for the cut off flange and place a mark on the furring strip. Snap a chalk line between the two points which is the alignment for the edge of the tile. Place tile in position, with the flange flush to the chalk line. Staple in place, using three staples along the flange that rests on the furring. Border tiles must be nailed or stapled to the furring along the wall, or be supported by a wall angle.

STEP 3

Continue installing the remaining tiles by gently sliding the tongue into the groove, making sure that the joints form a straight line in both directions. For every tile use three staples along the flange resting on the furring and one staple to the opposite angle.

STEP 4

Perimeter tiles need to be trimmed and cut to the required size. Fit in place, making sure the tile is nailed to the furring along the wall. Moldings should then be used to fill the gap between the ceiling tiles and the wall. Nail moldings into the wall studs at least every 24".

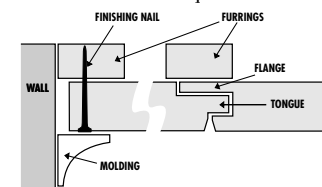

APPLICATION INSTRUCTIONS AND MATERIALS ESTIMATOR



9510 St. Patrick St., LaSalle, Québec, Canada H8R 1R9
3703 – 101 Avenue N.E., P. O. Box 576, Edmonton, Alberta, Canada T5J 2K8
Web site: www.bpcan.com

HOW TO INSTALL A SUSPENDED CEILING

STEP 1



Establish the desired height of your new BP Ceiling a minimum of 3" below the existing ceiling or exposed joists or ducts.

STEP 2

With a level and chalk line, mark $\frac{3}{4}$ " above the height of the new ceiling on the walls around the perimeter of the room.



STEP 3



Nail the wall angle flange to the wall with the bottom edge flush to the chalk line. At the corners, the wall angles may be either butted (A) or overlapping (B).

A



Folded wall angle

B



Mitred wall angle

STEP 4

Consult your plan to locate the position of your Main Tees. Use a chalk line to mark the position above the wall angle flange on each side of the room. Remember that the Main Tees must be perpendicular to the joists.

STEP 5

For proper suspension, the hanger clips must be fastened 4' apart. To make sure they are all at the same height and

properly aligned, drive a nail $\frac{1}{4}$ " higher than the marked position above the wall angle flange on each side of the room. Stretch the chalk line between the two nails and adjust the position of the hanger clips by having the notch in the clip touch the chalk line. Repeat this procedure for the remaining Main Tees.



In some areas, you may not have any joists to enable you to nail hanger clips. As an alternative, we recommend using eyelet or hook screws and 18-caliber steel wire. Drive either screw into any available support structure (existing ceiling, planks, beams) and tie the steel wire to it. Adjust the length of the wire by folding it at a right angle where it meets one of the Main Tee's holes. Leave enough wire so you can twist it after insertion into the Main Tee.

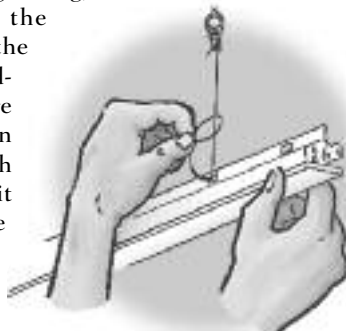

Note: If you are planning to install recessed lighting or flush-mounted fixtures, perform these tasks now.

STEP 6

The application of your Main Tees will demand your careful attention. If this task is performed well, your panels should be properly aligned and the border panels of equal width on both sides of the room. With each starting Main Tee, the distance between the starting wall and the Cross-Tee must be the same. This distance is determined by the size of the border panel in your plan.

To install the Main Tees:



- Cut to predetermined size.
- Insert into wall angle flange and snap into pre-installed hanger clips.
- Should more than one Main Tee length be re-

quired, you can easily fit them into one another. The location at which they are joined must be no more than 6" away from a hanger clip. Otherwise, install a clip with a steel wire.



STEP 7

You are now ready to install your 4' Cross-Tees. Begin with the border panel Cross-Tee and applying the rest at 4' intervals. You need to insert the splicing tongue of the Cross-Tee into the slot of the Main Tee.

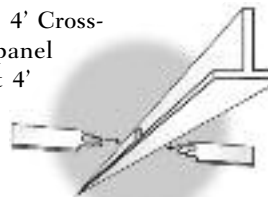

STEP 8

Once you have determined the layout of the panels (placed either parallel or perpendicular to the Main Tees), you should install the missing 4' Cross-Tees.

STEP 9



If installing 2' x 4' panels, you can begin the installation immediately. Tip your panel up through the grid opening and lower it into place.

STEP 10

If you selected 2' x 2' panels, you must insert 2' Cross-Tees into the middle of the 4' Cross-Tees, as indicated previously.

STEP 11

Install the 2' x 2' panels in the same fashion described earlier for 2' x 4' panels.

USEFUL TIPS

1) To cut Tees and wall angle flanges, use shears as illustrated.



2) To cut panels, use a utility knife as illustrated.

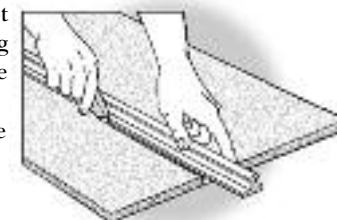

If you do not have a long ruler, use a Tee section.

N.B. Make sure to cut on the finished side.

3) To wrap around a column or post, measure its diameter and trace its position on the panel. Cut panel as illustrated.



4) Install recessed light fixtures and pass electric wires prior to installing your panels. **WARNING:** Fixtures must be fastened onto the existing ceiling or joists. The BP Ceiling System is designed to support panels only and in certain cases insulation.

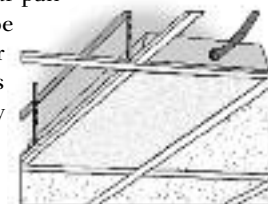

5) Extend your heating/cooling ducts to reach the new ceiling. Cut a hole in the panel and install vents.

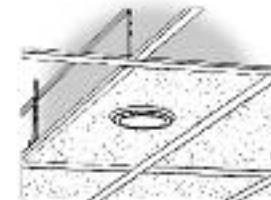

6) For windows that reach above the new ceiling, build a boxframe using $\frac{3}{4}$ " wood and fasten to the wall and joists. Leave enough space inside the boxframe to allow the opening and closing of windows and curtains. Fasten L-shaped braces onto the boxframe's exterior at the same height as you would to the wall.

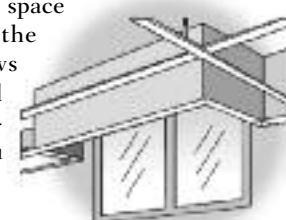

PLANNING AND ESTIMATING QUANTITIES FOR LAY-IN PANELS

Proper planning is a do-it-yourselfer's best ally. That's why we've prepared for you a list of steps you should follow when planning your new BP Ceiling.

HOW TO DRAFT A PLAN for a 2' x 2' or 2' x 4' suspended ceiling

MAIN MATERIALS

A description of the main materials you will use will help you better understand the steps that follow.

- 1) PANELS:** You can choose between 2' x 2' or 2' x 4' panels. (Refer to the BP Designer Ceilings pamphlet for more information on the wide range of styles and their individual features.)

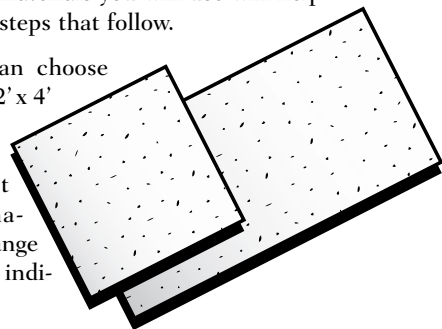

- 2) WALL ANGLE FLANGE:** This L-shaped component must be installed first. It is applied to the walls at the height of your ceiling and runs the entire perimeter of the room. It is used to support the edges of the tiles and Tees.

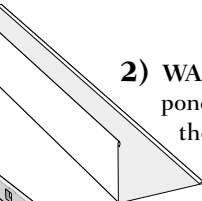

- 3) MAIN TEE:** This T-shaped component, either 8' or 12' long, is installed right after the wall angle flange. It serves to support the weight of your new ceiling at every 4' interval.

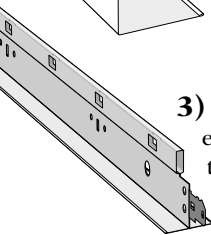

- 4) CROSS-TEE:** Also T-shaped, either 2' or 4' long and smaller in size than the Main Tee. Together with the latter, it forms the necessary grid to support the four edges of the panel.

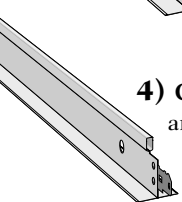

DRAFTING A PLAN TO CALCULATE QUANTITIES OF MATERIALS

STEP 1

CEILING DIAGRAM

Trace your room's dimensions on the grid sheet, included in this pamphlet.

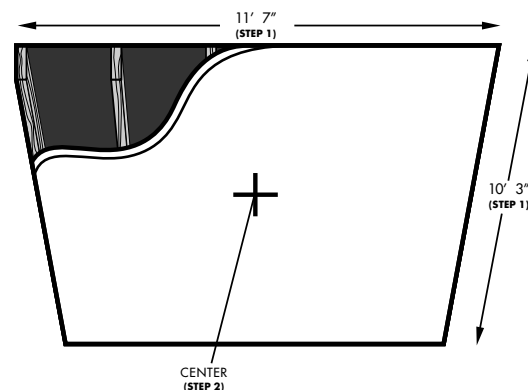

STEP 2

ROOM CENTER

Determine your ceiling's centerpoint.

STEP 3

TRACE POSITION OF MAIN TEES

- Perpendicular to the joists, draw one Main Tee 2' from the centerpoint determined in step 2.
- Trace remaining Main Tees at 4' intervals, starting from the Main Tee already drawn in your plan.

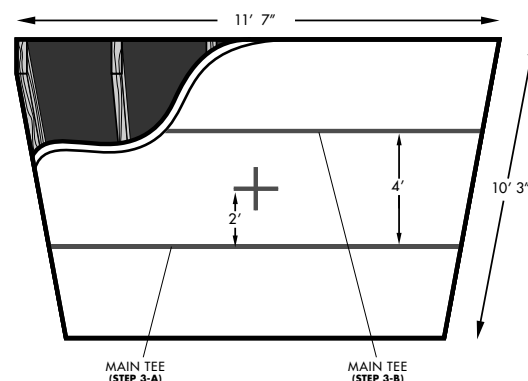

STEP 4

TRACE POSITION OF CROSS-TEES PERPENDICULAR TO MAIN TEES

- Trace one 4' Cross-Tee 2 feet from the centerpoint determined in step 2.
- Starting from the Cross-Tee traced in A, draw additional Cross-Tees at 4' intervals. You should now have a series of 4' x 4' squares.

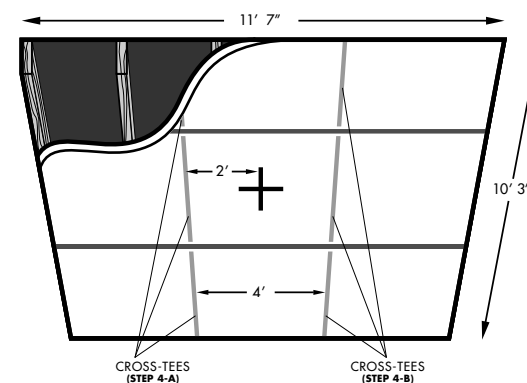

STEP 5

DETERMINING 2' X 4' PANEL DIRECTION AND TRACING REMAINING CROSS-TEES

- 2' x 4' panels running in the same direction as the Main Tees.**

Trace additional 4' Cross-Tees at 2' intervals, starting from Main Tees traced in step 3 and perpendicular to the Cross-Tees traced in step 4.

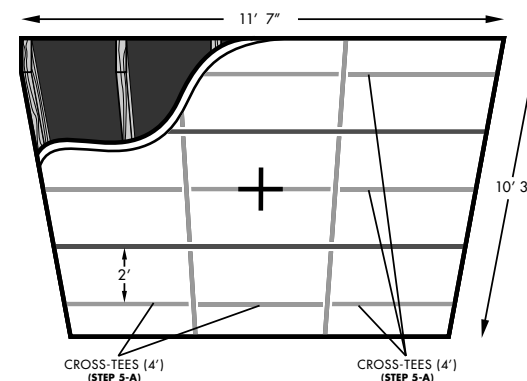

- 2' x 4' panels running in the opposite direction as that of the Main Tees.**

Trace additional 4' Cross-Tees at 2' intervals, starting from Cross-Tees traced in step 4 and perpendicular to the Main Tees traced in step 3.

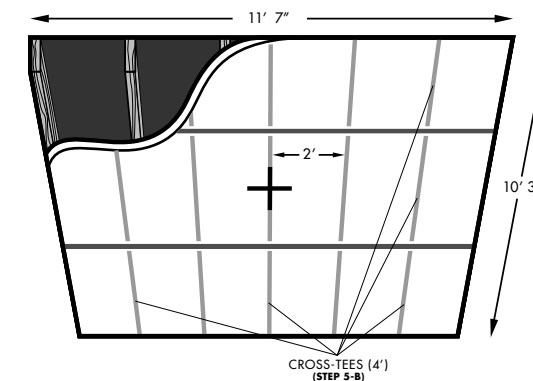

STEP 6

FOR 2' X 2' PANEL INSTALLATION TRACING REMAINING CROSS-TEES

Follow the procedure illustrated in 5A or 5B. To form perfect squares, draw 2' Cross-Tees in the middle of the 2' x 4' rectangles.

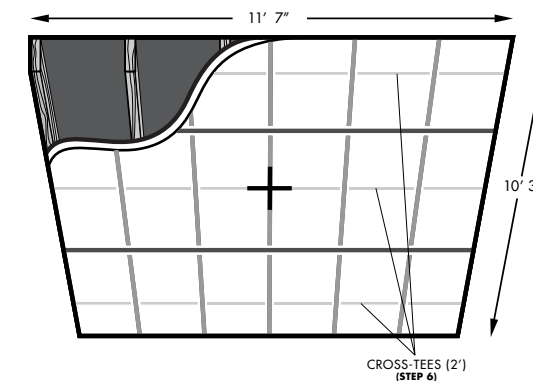
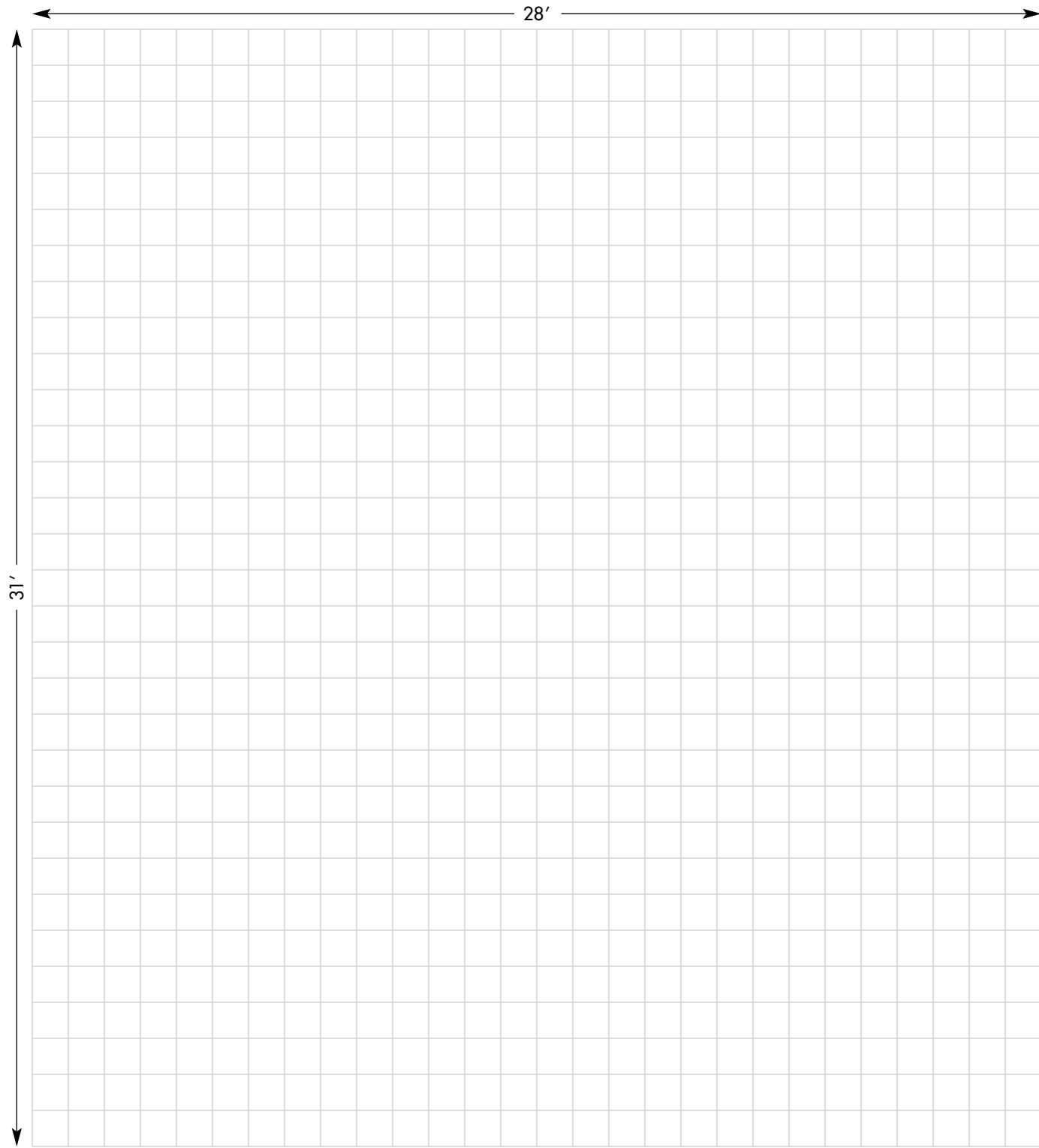

Illustration reflects orientation chosen in 5B.

Tiles and panels should be stored in a dry and well ventilated area. In addition, they should be unpacked to adjust to normal room conditions 24 hours prior to installation.



Scale: 1 square = 1 square foot

CALCULATING SUSPENSIONS AND PANELS

A. Use this table if the Main Tees run parallel to the longer wall. (Main Tees perpendicular to the joists).

ROOM SIZE (IN FEET)	8x10	8x12	8x14	10x10	10x12	10x14	10x16	12x12	12x14	12x16	12x20	14x16	14x20	14x24	14x28	16x16	16x18	16x20	16x24	16x30	18x18	18x20	18x24	18x28	18x32
WALL ANGLE FLANGE (IN FEET)	36	40	44	40	44	48	52	48	52	56	54	60	68	76	84	64	68	72	80	92	72	76	84	92	100
8' MAIN TEES	2	2	2	3	3	4	4	3	4	4	5	6	8	9	11	6	7	8	9	12	9	10	12	14	16
12' MAIN TEES	1	1	2	2	2	3	3	2	3	3	4	4	5	6	7	4	5	5	6	8	6	7	8	10	11
2' x 4' SUSPENDED CEILING																									
2' x 4' PANELS	10	12	14	15	18	21	24	18	21	24	30	24	40	44	52	32	36	40	48	56	45	50	60	70	80
4' CROSS-TEES	8	10	12	12	15	18	21	15	18	21	27	28	36	40	48	28	32	36	44	52	40	45	55	65	75
2' x 2' SUSPENDED CEILING																									
2' x 2' PANELS	20	24	28	25	30	35	40	36	42	48	60	56	70	77	91	64	72	80	96	112	81	90	108	126	144
2' CROSS-TEES	10	12	14	10	12	14	16	18	21	24	30	24	30	33	39	32	36	40	48	56	36	40	40	56	64
4' CROSS-TEES	8	10	12	10	13	15	18	15	18	21	27	25	32	35	42	28	32	36	44	52	36	41	50	59	68

B. Use this table if the Main Tees run parallel to the shorter wall. (Main Tees perpendicular to the joists).

ROOM SIZE (IN FEET)	8x10	8x12	8x14	10x10	10x12	10x14	10x16	12x12	12x14	12x16	12x20	14x16	14x20	14x24	14x28	16x16	16x18	16x20	16x24	16x30	18x18	18x20	18x24	18x28	18x32
8' MAIN TEES	2	2	3	3	3	4	4	3	5	5	6	6	7	9	11	6	8	8	10	12	9	9	12	14	16
12' MAIN TEES	2	2	2	2	2	3	3	2	3	3	4	4	5	6	7	4	6	6	7	8	6	6	8	9	11
2' x 4' SUSPENDED CEILING																									
2' x 4' PANELS	12	12	16	15	15	20	20	18	24	24	30	28	35	42	49	32	40	40	48	56	45	45	54	63	72
4' CROSS-TEES	9	9	12	12	12	16	16	15	20	20	25	24	30	36	42	28	35	35	42	49	40	40	48	56	64
2' x 2' SUSPENDED CEILING																									
2' x 2' PANELS	20	24	28	25	30	35	40	36	42	48	60	56	70	77	91	64	72	80	96	112	81	90	108	126	144
2' CROSS-TEES	8	12	12	10	15	15	20	18	18	24	30	28	35	35	42	32	32	40	48	56	36	45	54	63	72
4' CROSS-TEES	8	9	11	10	12	14	16	15	18	20	25	24	30	33	39	28	32	35	42	49	36	40	48	56	64

