

User Manual



Contents

1.0	Installation Overview	3
1.1	<i>Introduction</i>	3
1.2	<i>Specifications</i>	4
2.0	Warnings	5
3.0	Tools and Materials Needed	5
4.0	Choosing a Location	6
5.0	Choosing an Array	6
6.0	Installation Instructions	7
7.0	Wiring Diagram	10
7.1	<i>Stand Alone Controller</i>	10
7.2	<i>Two Paralleled Controllers</i>	10
8.0	Operating Instructions	12
8.1	<i>Power Up</i>	12
8.2	<i>Setting the Stand-alone or Parallelization Mode</i>	12
8.3	<i>Setting the Battery Charging Profile</i>	13
8.4	<i>Battery Charging Profile Chart</i>	14
8.5	<i>Maximum Power Boost Technology™</i>	14
8.6	<i>Viewing the Controller Display Information</i>	15
8.7	<i>Errors</i>	16
9.0	Frequently Asked Questions (FAQs)	18
10.0	Troubleshooting Problems	18
10.1	<i>Problems with the LED Display</i>	18
10.2	<i>Problems with Voltage</i>	19
10.3	<i>Problems with Charging</i>	20
10.4	<i>Problems with Paralleled Controllers</i>	22
11.0	Limited Warranty	22
11.1	<i>Repair and Return Information</i>	23

1.0 Installation Overview

1.1 Introduction

A Solar Controller (or Charge Controller / Regulator) is an essential component of your photovoltaic solar system. The Controller maintains the life of the battery by protecting it from overcharging. When your batteries have reached a 100% state of charge, the Controller prevents overcharging by limiting the current flowing into the batteries from your solar array.

The GP-MPPT-40 is a 12 or 24 volt photovoltaic (PV) charge controller rated for a continuous solar current input of 40 amps. The GP-MPPT-40 uses Maximum Power Point Tracking (MPPT) technology and a unique four stage charging system that includes an optional equalize setting to charge and protect your battery bank. The GP-MPPT-40 features an LED display that shows system status.

The GP-MPPT-40 also features an optional LCD display accessory that shows the charge current of the solar array, battery voltage, and battery state of charge (SOC). The GP-MPPT-40 also features Maximum Power Boost Technology™ for manual bulk and absorption charge at any stage of the charge cycle when used in combination with the optional display accessory.

Part number: GP-MPPT-R

Contact your dealer or call Go Power! at 1-866-247-6527 for ordering information.

1.2 Specifications

NOTE

Values before and after the slash correspond to 12 and 24 V systems respectively.

Description	Value	Dimensions (H x W x D):
Nominal System Voltage	12 / 24V	173 x 169 x 57 mm 6.81 x 6.65 x 2.24 in Weight: 1.2kg / 2.6lbs
Max. Solar Array Current	40A (amperage is reduced above 50°C)	Maximum Wire Gauge: #2 AWG
Max. Solar Array Power	600/1200W	Warranty: 5 years
Battery Voltage Range	9V – 31V Must be >9 / 18V for charging	<ul style="list-style-type: none"> • MPPT charging • 4 battery charging profiles • 4 stage charging • Monthly equalize option • LED display for errors and charging state • Reverse polarity protected • Temperature compensated • RoHS compliant, environmentally safe • Accepts up to 600 watts of solar at 12 volts, up to 1200 watts of solar at 24 volts • Maximum Power Boost Technology
Max. Solar Voltage	150 Voc Must include temperature effects. Refer to Section 5.0	
Operating Consumption	0.7W	
Bulk/Absorption Voltage (Sealed/Gel, AGM/Lithium, Flooded)	14.1/28.2V, 14.4/28.8V, 14.4/28.8V (25°C, 77°F), 30min per day or 2hr if battery voltage < 12.3/24.6V	
Float Voltage	13.8/27.6V (25°C, 77°F)	
Equalization Voltage	14.9/29.8V (25°C, 77°F), 2hr every 30 days or if battery voltage < 12.1/24.2V	
Temperature Compensation	-24mV/°C, -13mV/°F (12V systems) -48mV/°C, -26mV/°F (24V systems) Requires battery temperature accessory	
Operating Temperature	- 40 to 60°C, - 40 to 140°F	
Humidity	99% N.C.	
Protection	Battery Reverse Polarity (up to 35V), Solar Array Reverse Polarity, Over Temperature, PV Short Circuit, Battery Short Circuit, Over Current	







The total rated maximum open circuit voltage of the PV input must not exceed 150 volts.

Damage may occur if the GP-MPPT-40 is connected to greater than 150 volts of PV input. Be sure to account for temperature effects. Panel/Array voltage increases in cold weather. Consult section 5.0 for sizing guidelines.

The total rated maximum current of the PV input should not exceed 40 amps.

The GP-MPPT-40 will limit charge current above 40 Amps, and excess current will not be utilized.

2.0 Warnings

	Disconnect all power sources	Electricity can be very dangerous. Installation should be performed only by a licensed electrician or qualified personnel.
	Battery and wiring safety	Observe all safety precautions of the battery manufacturer when handling or working around batteries. When charging, batteries produce hydrogen gas, which is highly explosive.
	Wiring connections	Ensure all connections are tight and secure. Loose connections may generate sparks and heat. Be sure to check connections one week after installation to ensure they are still tight.
	Work safely	Wear protective eyewear and appropriate clothing during installation. Use extreme caution when working with electricity and when handling and working around batteries.
	Observe correct polarity	Reverse polarity of the battery terminals and array will cause the controller to show warning LEDs. The controller will not function unless battery terminals are connected to a battery with proper polarity. Failure to correct these faults could damage the controller.
	Do not exceed the GP-MPPT-40 max voltage ratings	The voltage rating of the solar system is the sum of the Open Circuit Voltage (Voc) of the solar PV panels in series. The resulting system Voc voltage including temperature effects is not to exceed 150V. If your solar system exceeds these ratings, contact your dealer for a suitable controller alternative. PV voltage increases in cold weather. Refer to section 5.0.

3.0 Tools and Materials Needed

- Flathead Screwdriver (for wire terminals)
- Small Flathead Screwdriver (for temperature sensor accessory)
- Philips Screwdriver (for mounting screws)

NOTE

If the GP-MPPT-40 Controller was purchased with a Go Power! RV Solar Power Kit then UV resistant wire is included. For instructions regarding the Go Power! RV Solar Power Kit installation, please refer to the Installation Guide provided with the Kit.

4.0 Choosing a Location

The GP-MPPT-40 is designed to be mounted vertically in a battery box.

The GP-MPPT-40 should be:

- Mounted as close to the battery as possible
- Mounted on a vertical surface to optimize cooling of the unit
- Indoors, protected from the weather

The wire from the solar array most commonly enters the RV through the fridge vent on the roof or by using the Go Power! Cable Entry Plate (sold separately) that allows installers to run wires through any part of the roof. PV connections should connect directly to the controller. Positive and negative battery connections must connect directly from the controller to the batteries. Use of a positive or negative distribution bus is allowed between the controller and battery as long as it is properly sized, electrically safe and an adequate wire size is maintained.

5.0 Choosing an Array

The panel voltage must not exceed 150V, or the controller will be damaged. Panel voltage increases in cold weather compared to STC ratings, so the highest panel voltage must be calculated for the worst case cold weather.

1. **Determine the worst case cold temperature of the panel installation.**
2. **Select the NEC temperature correction factor matching the worst case cold temperature of the panel installation. Refer to table 690.7(A) of NEC 2017 or the latest version. When in doubt, select 1.25.**

3. **Sum the open circuit voltages (Voc) of panels wired in series to obtain the array open circuit voltage at standard test conditions (STC).**
4. **Multiply the array open circuit voltage by your selected NEC temperature correction factor, or multiply by 1.25 if you don't know which factor to choose.**
5. **The calculated value must be less than 150V. If not, select a different wiring configuration for the solar panels with fewer in series.**

For example, the FLEX-100 has a Voc of 20.8V at STC. If six FLEX-100 solar panels were wired in series, then the array Voc would be 124.8V at STC. If the array were to be used in temperatures down to -40°C, then the NEC temperature correction factor would be 1.25. Multiplying the array Voc by 1.25 is 156V. This is greater than the allowed 150V, and the panels should be wired in a different configuration.

6.0 Installation Instructions

1. **Complete the installation of the solar modules.** If this GP-MPPT-40 was purchased as part of a Go Power! Solar Power Kit, follow the Installation Guide provided. Otherwise, follow manufacturer's instructions for solar module mounting and wiring.
2. **Select DIP switches for battery type and parallelization.** DIP switches 1 and 2 control battery type for AGM, sealed/gel or flooded. DIP switch 3 controls stand-alone or parallelization modes. See **Section 8.2** for more details.
3. **Connect temperature sensor accessory.** Secure wires into 2 position screw terminal block. Mount ring terminal to battery. Attach ring terminal to battery lug, or use neoprene tape to attach ring terminal to battery case. Insert terminal block into controller's temperature port.

NOTE

Temperature compensated charging is only enabled when the temperature sensor accessory is attached to the controller.

4. **(Optional) Connect two controllers if using parallelization mode.** Secure the Ethernet cable to port A of one controller and to port B of the other controller. Be sure that DIP switch 3 is on for only 1 controller.

5. **Select wire type and gauge.** If this GP-MPPT-40 was purchased as part of a Go Power! Solar Power Kit, appropriate wire type, gauge and length is provided. Please continue to **Section 6.0**, “Operating Instructions.” If the GP-MPPT-40 was purchased separately, follow the instructions included here.

Wire type is recommended to be a stranded copper UV resistant wire. Wire fatigue and the likelihood of a loose connection are greatly reduced in stranded wire compared to solid wire. Wire gauge should be able to sustain rated current and minimize voltage drop.

Wire Strip Length

Strip wires 12mm.

Suggested Minimum Wire Gauge

(Cable length 25 ft. max. from solar array to battery bank)

50 Watt Solar Module	#14 Wire Gauge
80 Watt Solar Module	#12 Wire Gauge
95 Watt Solar Module	#10 Wire Gauge
110 Watt Solar Module	#10 Wire Gauge
125 Watt Solar Module	#10 Wire Gauge
160 Watt Solar Module	#10 Wire Gauge
240 Watt Solar Module	#10 Wire Gauge

IMPORTANT: Identify the polarity (positive and negative) on the cable used for the battery and solar module. Use colored wires or mark the wire ends with tags. Although the GP-MPPT-40 is protected, a reverse polarity contact may damage the unit.

Wiring the GP-MPPT-40. Wire the GP-MPPT-40 according to the wiring schematic in **Section 6.0**. Run wires from the solar array and the batteries to the location of the GP-MPPT-40. Keep the solar array covered with an opaque material until all wiring is completed.

- 6. Torque** all terminal screws according to the chart below. Connect the battery wiring to the controller first, and then connect the battery wiring to the battery.

Stranded Copper 90°C Wire Terminal Screw Torque	
Wire Size AWG	Rated Torque (in-lbs)
10	20
8	25
6	35
4	35

IMPORTANT: Always use appropriate circuit protection on any conductor attached to a battery.

With battery power attached, the controller should power up and display LEDs. Connect the solar wiring to the controller and remove the opaque material from the solar array. The negative solar array and battery wiring must be connected directly to the controller for proper operation. Solar array leads must only be connected to their appropriate wire terminal on the solar charge controller. Do not connect negative solar array leads to the charge controller via the vehicle chassis.

- 7. Mounting the GP-MPPT-40.** Mount the GP-MPPT-40 to the wall using the included four mounting screws. Mount vertically for best heat dissipation.

IMPORTANT: You must set the battery type on the GP-MPPT-40 before you begin to use the controller (follow steps in **Section 7**). The default battery setting is for AGM batteries.

Congratulations, your GP-MPPT-40 should now be operational. If the battery power is low and the solar array is producing power, your battery should begin to charge.

- 8. Re-torque:** After 30 days of operation, re-torque all terminal screws to ensure the wires are properly secured to the controller.

7.0 Wiring Diagram

The GP-MPPT-40 is based on a 40 amp, 600/1200W max input from the solar modules. Use the wiring diagram to connect your battery to the battery terminals on the solar controller. First, connect the battery to the controller, and then connect the solar panel to the controller.

The fuse or breaker used should be no larger than 60 amps for a stand-alone unit and no larger than 120 amps for two paralleled units.

NOTE

The controller will not work unless there is a battery connected to the battery terminals.

7.1 Stand Alone Controller

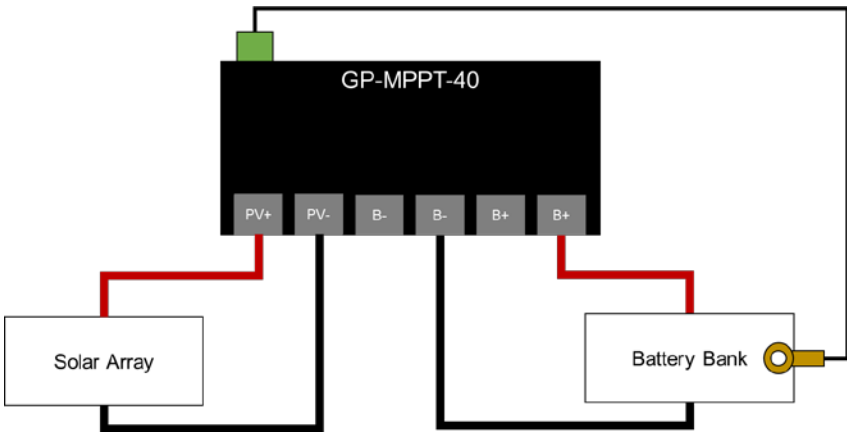

7.2 Two Paralleled Controllers

NOTE

The PV input on each individual controller should not exceed 150Voc, 600W for 12V, and 1200W for 24V systems.

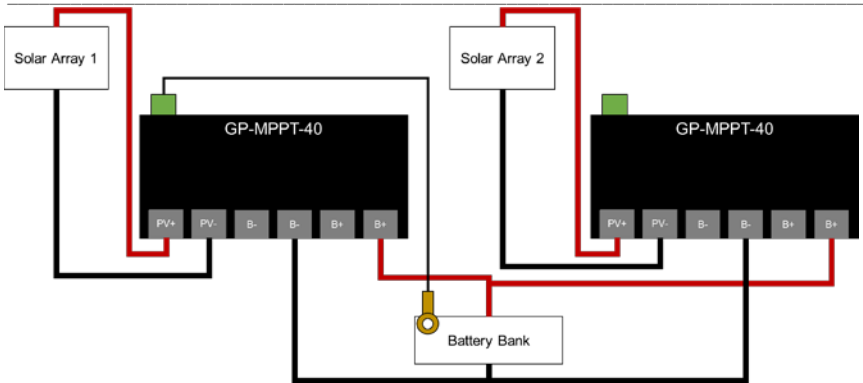

Correct parallelization port connection

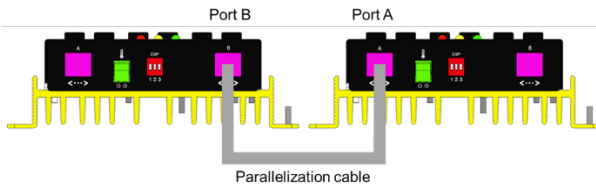

Incorrect parallelization port connections

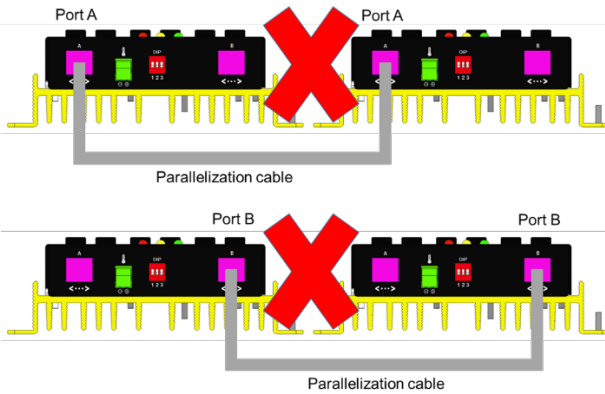

8.0 Operating Instructions

8.1 Power Up

When the GP-MPPT-40 is connected to the battery, the controller will go into Power Up Mode which takes about 10 seconds to complete.

LEDs Displayed: Green and Yellow LEDs will flash briefly and then turn off for about 4 seconds. They will then stay on for about 1 second. Next they will flash quickly for a few seconds and then slowly for a few more seconds. After 10 seconds the LEDs will begin to indicator errors, charging status, and battery SOC.

8.2 Setting the Stand-alone or Parallelization Mode

To select the stand-alone or parallelization mode, select the corresponding configuration of DIP switch 3. DIP switches 1 and 2 will not affect this mode.

For stand-alone mode, set DIP switch 3 OFF. (factory default)

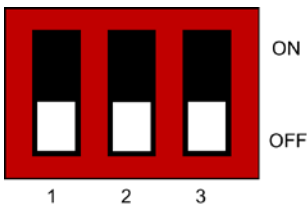

For parallelization mode, select one controller to be the master controller. Set its DIP switch 3 OFF. For the secondary slave controller, set DIP switch 3 ON.

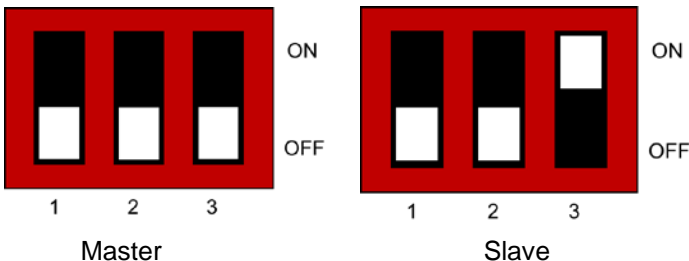

8.3 Setting the Battery Charging Profile

To select the battery charging profile, select the corresponding configuration of DIP switches 1 and 2. DIP switch 3 will not affect the charging profile.

For AGM/Lithium, set DIP switches 1 and 2 both OFF. (factory default)

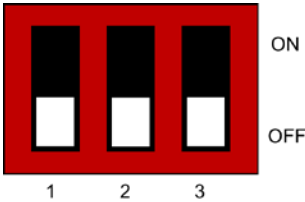

For sealed/gel, set DIP switches 1 and 2 both ON.

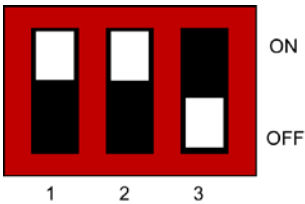

For flooded, set DIP switch 1 OFF and DIP switch 2 ON.

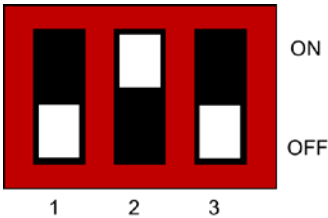

Refer to the Battery Charge Profile Chart below for details on each profile.

8.4 Battery Charging Profile Chart

NOTE

Values before and after the slash correspond to 12 and 24 V systems respectively.

Battery Type	SEALED /GEL	AGM/ Lithium	FLOODED
Float Charge @ 25°C:	13.8/27.6V (± 0.1/0.2V)		
Bulk/Absorption Charge @ 25°C: Set to 30 minutes every morning. <i>Applied for 2 hours if the battery voltage drops below 12.3/24.6 volts.</i>	14.1/28.2V (± 0.1/0.2V)	14.4/28.8V (± 0.1/0.2V)	14.4/28.8V (± 0.1/0.2V)
Equalization Charge @ 25°C: <i>Applied for 2 hours every 30 days and if the battery voltage drops below 12.1/24.2 volts.</i>	N/A	N/A	14.9/29.8V (± 0.1/0.2V)
The terms SEALED/GEL, AGM/Lithium and FLOODED are generic battery designations. Choose the charging profile that works best with your battery manufacturer's recommendations.			

Auto Equalize: The GP-MPPT-40 has an automatic equalize feature that will charge and recondition your batteries once a month at a higher voltage to ensure that any excess sulfation is removed.

NOTE

This feature is only available when Flooded batteries are selected.

8.5 Maximum Power Boost Technology™

Maximum Power Boost Technology™ (MPBT) allows you to override the normal charging algorithm of the solar controller. MPBT is designed to be used before the end of the day if you know you will require many loads through the night.

MPBT is only available with the optional remote display accessory GP-MPPT-R.

Contact your dealer or call Go Power! at 1-866-247-6527 for ordering information.

MPBT will add 30 minutes of absorption if it triggered by the button on the remote display and there is sufficient PV power available. For example, if the Max Boost button is pressed on the remote display while the controller is performing Float charge, then the controller will try to charge at the Boost voltage for 30 minutes and then return to Float charge.

IMPORTANT: Do not use the Maximum Power Boost function more than twice a day as it could damage your batteries due to gassing.

8.6 Viewing the Controller Display Information

NOTE

Values before and after the slash correspond to 12 and 24 V systems respectively.

Power Up Mode:

When the GP-MPPT-40 is connected to the battery, the controller will go into Power Up Mode which takes about 10 seconds to complete. Green and Yellow LEDs will flash briefly and then turn off for about 4 seconds. They will then stay on for about 1 second. Next they will flash quickly for a few seconds and then slowly for a few more seconds. After 10 seconds the LEDs will begin to indicator errors, charging status, and battery SOC.

LEDs Displayed:

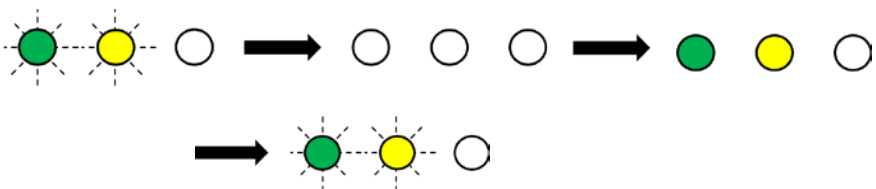

Battery State of Charge (SOC):

When the battery voltage falls below 12.0/24.0V, the yellow LED will turn on. When the battery voltage falls below 11.5/23.0V, the yellow LED will flash.

Battery Voltage > 12.0/24.0V:

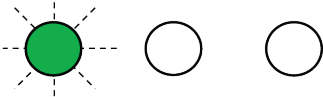

12.0/24.0V > Battery Voltage > 11.5/23.0V:

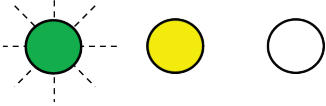

11.5/23.0V > Battery Voltage:

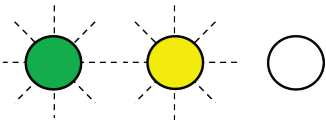

Charging Mode

When the GP-MPPT-40 is charging, the green LED will flash. When the GP-MPPT-40 is not charging, the green LED will be on.

Charging:

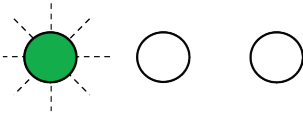

Not Charging:

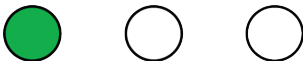

8.7 Errors

Battery Over Voltage

If the GP-MPPT-40 experiences a battery over voltage (15.5/31.0V), the controller will stop operating, and the display will begin to flash the green and yellow LEDs. The controller will resume operating when the error is cleared.

Battery Over Voltage:

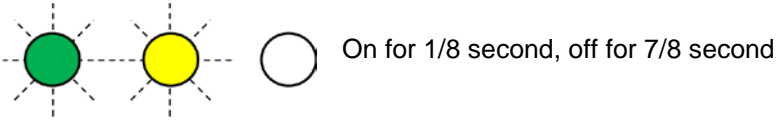

Battery Low Voltage

If the battery state of charge reaches 0%, the Yellow LED will turn on. The controller will continue operating in this condition and will only stop charging if the voltage drops below 9 volts.

11.5/23.0V > Battery Voltage:

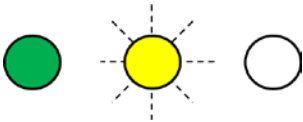

Reverse Polarity

If the battery is connected with reverse polarity, the red LED will turn on. If the solar array is connected with reverse polarity while the battery is connected with correct polarity, the green and yellow LEDs will flash.

Battery Reverse Polarity:



Solar Array Reverse Polarity:

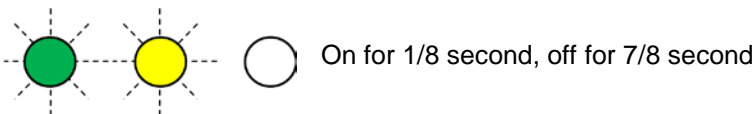

NOTE

Solar reverse polarity will short circuit the array. This can overheat the controller and should be fixed as soon as possible.

9.0 Frequently Asked Questions (FAQs)

Before a problem is suspected with the system, read this section. There are numerous events that may appear as problems but are in fact perfectly normal. Please visit **gpelectric.com** for the most up-to-date FAQs.

It seems like my flooded batteries are losing water over time.

Flooded batteries may need to have distilled water added periodically to replace fluid loss during charging. Excessive water loss during a short period of time indicates the possibility of overcharging or aging batteries.

When charging, my flooded batteries are emitting gas.

During charging, hydrogen gas is generated within the battery. The gas bubbles stir the battery acid allowing it to receive a fuller state of charge.

Important: **Ensure batteries are in a well-ventilated space.**

10.0 Troubleshooting Problems

How to Read this Section

Troubleshooting Problems is split into three sub-sections, grouped by symptoms involving key components. Components considered irrelevant in a diagnosis are denoted 'Not Applicable' (N/A). A multimeter or voltmeter may be required for some procedures listed.

It is imperative all electrical precautions stated in the Warning Section and outlined in the Installation Section are followed. Even if it appears the system is not functioning, it should be treated as a fully functioning system generating live power.

10.1 Problems with the LED Display

Display Reading: Blank (no LEDs)

Time of Day: Daytime/Nighttime

Possible Causes:

Battery or fuse connection.

How to tell:

1. Check the voltage at the controller battery terminals with a voltmeter and compare with a voltage reading at the battery terminals.
2. If there is no voltage reading at the controller battery terminals, the problem is in the wiring between the battery and the controller. If the battery voltage is lower than 9 volts, the controller will power off.

Remedy:

Check all connections from the controller to the battery including checking for correct wire polarity. Check that all connections are clean, tight, and secure. Ensure the battery voltage is above 7 volts.

Display Reading: Nighttime (green LED on, not flashing)

Time of Day: Daytime

Possible Causes:

Panel is covered by something, PV panel is too dirty to supply a high enough voltage to charge the battery, PV panel is not connected.

Remedy:

Check the panel and to ensure it is not obscured. Clean the panel if it is dirty. Check that PV cables are connected to the controller.

10.2 *Problems with Voltage*

Voltage Reading: Inaccurate (yellow LED on or flashing unexpectedly)

Time of Day: Daytime/Nighttime

Possible Cause:

Excessive voltage drop from batteries to controller due to loose connections, small wire gauge or both. Excessive load power draw.

How to tell:

1. Check the voltage at the controller battery terminals with a voltmeter and compare with the voltage reading at the battery terminals.

2. If there is a voltage discrepancy of more than 0.5 V, there is an excessive voltage drop.
3. Check the battery voltage when loads are on, and recheck the battery voltage when loads are off. If there is a voltage discrepancy of more than 1V, the loads are too large.

Remedy:

(2) Check all connections from the controller to the battery including checking for correct wire polarity. Check that all connections are clean, tight, and secure. Shorten the distance from the controller to battery or obtain larger gauge wire. It is also possible to double up the existing gauge wire (i.e. two wire runs) to simulate a larger gauge wire.

(3) Increase the battery capacity. Consult your dealer or installer for assistance.

10.3 Problems with Charging

Problem: Controller doesn't seem to be charging

Time of Day: Daytime, clear sunny skies

Possible Cause:

Current is being limited as per normal operation or poor connection between solar array and controller.

How to tell:

1. The green LED is flashing if charging. The green LED is on if not charging or there's insufficient solar voltage.
2. With the solar array in sunlight, check the voltage at the controller solar array terminals with a voltmeter.
3. If there is no reading at the controller solar array terminals, the problem is somewhere in the wiring from the solar array to the controller.

Remedy:

Check all connections from the controller to the array including checking for correct wire polarity. Check that all connections are clean, tight, and

secure. Continue with the solutions below for additional help on low current readings.

Current Reading: Less than expected

Time of Day: Daytime, clear sunny skies

Possible Causes:

- (1) Current is being limited as per normal operation.
- (2) Incorrect series/parallel configuration and/or wiring connections and/or wire gauge.
- (3) Dirty or shaded module or lack of sun.
- (4) Blown diode in solar module when two or more modules are connected in parallel.

How to tell:

- (2) Check that the modules and batteries are configured correctly. Check all wiring connections.
- (3) Modules look dirty, overhead object is shading modules or it is an overcast day in which a shadow cannot be cast.

NOTE

Avoid any shading no matter how small. An object as small as a broomstick held across the solar module may cause the power output to be reduced. Overcast days may also cut the power output of the module.

- (4) Disconnect one or both array wires from the controller. Take a voltage reading between the positive and negative array wire. A single 12 volt module should have an open circuit voltage between 17 and 22 volts. If you have more than one solar module, you will need to conduct this test between the positive and negative terminals of each module junction box with either the positive or the negative wires disconnected from the terminal.

Remedy:

- (2) Reconnect in correct configuration. Tighten all connections. Check wire gauge and length of wire run. Refer to Suggested Minimum Wire Gauge in **Section 6**.
- (3) Clean modules, clear obstruction or wait for conditions to clear.

(4) If the open circuit voltage of a non-connected 12 volt module is lower than the manufacturer's specifications, the module may be faulty. Check for blown diodes in the solar module junction box, which may be shorting the power output of module.

10.4 Problems with Paralleled Controllers

Problem: Green and yellow LED are flashing on one or both controllers

Possible Cause:

Incorrect connection between controllers, incorrect DIP switch selections

How to tell:

1. Verify that port A of one controller is connected to port B of the other controller.
2. Verify that DIP switch 3 of one controller is on (up) and DIP switch 3 of the other controller is off (down).

Remedy:

(1) Switch Ethernet cable connections so that port A of one controller is connected to port B of the other controller.

(2) Change DIP switch 3 so that for one controller it is on (up) and for the other controller is off (down).

11.0 Limited Warranty

1. Go Power warrants the GP-MPPT-40 for a period of five (5) years from the date of shipment from its factory. This warranty is valid against defects in materials and workmanship for the five (5) year warranty period. It is not valid against defects resulting from, but not limited to:
 - Misuse and/or abuse, neglect, or accident
 - Exceeding the unit's design limits
 - Improper installation, including, but not limited to, improper environmental protection and improper hook-up
 - Acts of God, including lightning, floods, earthquakes, fire, and high winds

-
- Damage in handling, including damage encountered during shipment
2. This warranty shall be considered void if the warranted product is in any way opened or altered. The warranty will be void if any eyelet, rivets, or other fasteners used to seal the unit are removed or altered, or if the unit's serial number is in any way removed, altered, replaced, defaced, or rendered illegible.

11.1 *Repair and Return Information*

Visit www.gpelectric.com to read the “frequently asked questions” section of our website to troubleshoot the problem. If trouble persists:

1. Call your Go Power!® Technical Support team (1-866-247-6527).
2. Return defective product to place of purchase



© 2020 GO POWER!® By Valterra Products, LLC

80636_MANUAL_GP-MPPT-40_RevB

*gp*electric.com