

# User Manual

## GP-MPPT-85/20



# Contents

<b>1.0</b>	<b>Installation Overview.....</b>	<b>3</b>
1.1	<i>Introduction</i>	3
1.2	<i>Regulatory Information</i>	3
1.3	<i>Specifications</i>	3
<b>2.0</b>	<b>IMPORTANT SAFETY INSTRUCTIONS.....</b>	<b>5</b>
<b>3.0</b>	<b>Choosing a Location.....</b>	<b>6</b>
<b>4.0</b>	<b>Choosing an Array.....</b>	<b>6</b>
<b>5.0</b>	<b>Installation.....</b>	<b>7</b>
5.1	<i>Tools and Materials Needed</i>	7
5.2	<i>Instructions</i>	7
<b>6.0</b>	<b>Wiring Diagram.....</b>	<b>8</b>
<b>7.0</b>	<b>Operating Instructions.....</b>	<b>9</b>
7.1	<i>Battery Charging Profile Chart</i>	9
7.2	<i>LED Display</i>	9
7.3	<i>Switching Between Battery Banks</i>	10
<b>8.0</b>	<b>Frequently Asked Questions (FAQs).....</b>	<b>10</b>
<b>9.0</b>	<b>Troubleshooting Problems.....</b>	<b>10</b>
9.1	<i>Blank LED Display</i>	11
9.2	<i>Red Battery LED On</i>	11
9.3	<i>Red Solar LED On</i>	12
9.4	<i>Problems with Charging</i>	12
<b>10.0</b>	<b>Limited Warranty.....</b>	<b>14</b>
10.1	<i>Repair and Return Information</i>	14

# 1.0 Installation Overview

## 1.1 Introduction

A Solar Controller (or Charge Controller / Regulator) is an essential component of your photovoltaic solar system. The Controller maintains the life of the battery by protecting it from overcharging. When your batteries have reached a 100% state of charge, the Controller prevents overcharging by limiting the current flowing into the batteries from your solar array.

The GP-MPPT-85/20 is a photovoltaic (PV) charge controller intended for use at 12 or 24 VDC system voltage and is rated for a nominal charge current of 20 amps.

The GP-MPPT-85/20 uses Maximum Power Point Tracking (MPPT) technology and a unique three stage charging algorithm.

The GP-MPPT-85/20 is suitable for use with lead acid batteries.

## 1.2 Regulatory Information



## 1.3 Specifications

**NOTE**

Values before and after the slash correspond to 12 and 24V systems respectively.

Description	Value	Dimensions (H x W x D):
Nominal System Voltage	12 / 24 VDC (auto detection)	150 x 128 x 42 mm 5.90 x 5.03 x 1.65 in
Nominal Charge Current	20 ADC	Weight: 1050 g 37.03 oz
Battery Input Voltage Range	9.0 to 15.5 VDC in 12V systems 18.0 to 31.0 VDC in 24V systems	Warranty: 5 years
Max. Solar Array Current Input	25 ADC Refer to Section 4.0	• MPPT charging
Max. Solar Array Power Input	250/500 W	• 3 stage charging
Max. Solar Voltage Input	85 VDC Must include temperature effects. Refer to section 4.0	• LED display for errors and charging state • Reverse polarity protected

Min Solar Voltage for Charging	17.0/34.0 VDC	<ul style="list-style-type: none"> <li>• Temperature compensated</li> <li>• RoHS compliant, environmentally safe</li> <li>• Accepts up to 250 watts of solar at 12 volts, up to 500 watts of solar at 24 volts</li> </ul>
Max. Series Fuse or Circuit Breaker Rating for Battery	30 ADC	
Grounding	Negative ground	
Operating Consumption	7-15mA	
Battery Types Supported	Lead acid	
Battery Voltage Charge Range	9.0 to 14.8 VDC in 12V systems 18.0 to 29.6 VDC in 24V systems	
Bulk/Absorption Voltage (AGM)	14.4/28.8V (25°C, 77°F), 30min per day or 2hr if battery voltage < 12.3/24.6V	
Float Voltage	13.8/27.6V (25°C, 77°F)	
Battery overvoltage protection level	15.5/31.0 VDC	
Temperature Compensation	-25 mV/K in 12V systems -50mV/K in 24V systems	
Operating Temperature	- 40 to 60°C, - 40 to 140°F	
Humidity	99% N.C.	
Wire Leads	13 AWG	
Connectors	Solar +: Male MC4 type Solar -: Female MC4 type Battery: Delphi Weather Pack 2 position male shroud	
Protection	Battery Reverse Polarity, Solar Array Reverse Polarity, Over Temperature, PV Short Circuit, Battery Short Circuit, Over Current	

**The total rated maximum open circuit voltage of the PV input should not exceed 85 volts.**

GP-MPPT-85/20 will not allow charging when connected to greater than 85 volts of PV input and will be permanently damaged by 100V or more of PV input. Be sure to account for temperature effects. Consult section 4.0 for sizing guidelines.

**The total rated maximum current of the PV input should not exceed 20 amps.**







The GP-MPPT-85/20 will limit solar current above 20 Amps, and excess current will not be utilized. Consult section 4.0 for sizing guidelines.

**Overcurrent protection is required between the controller and battery.**

## 2.0 IMPORTANT SAFETY INSTRUCTIONS

### SAVE THESE INSTRUCTIONS

THIS MANUAL CONTAINS IMPORTANT INSTRUCTIONS FOR MODEL GP-MPPT-85/20 THAT SHOULD BE FOLLOWED DURING INSTALLATION AND MAINTENANCE OF THE CHARGE CONTROLLER.

	<b>Disconnect all power sources</b>	Electricity can be very dangerous. Installation and maintenance should be performed only by a licensed electrician or qualified personnel.
	<b>Battery and wiring safety</b>	Observe all safety precautions of the battery manufacturer when handling or working around batteries. When charging, batteries produce hydrogen gas, which is highly explosive. All conductors attached to a battery must have appropriate fuses or circuit breakers.
	<b>Wiring connections</b>	Ensure all connections are tight and secure. Loose connections may generate sparks and heat. Be sure to check connections one week after installation to ensure they are still tight.
	<b>Work safely</b>	Wear protective eyewear and appropriate clothing during installation. Use extreme caution when working with electricity and when handling and working around batteries.
	<b>Observe correct polarity</b>	The controller will not function unless battery wire leads are connected to a battery with correct polarity. If the PV array is connected with reverse polarity, it will cause a short circuit. Failure to correct these faults could damage the controller.
	<b>Do not exceed GP-MPPT-85/20 max current ratings</b>	Add parallel-connected PV module rated short circuit currents (Isc) at STC. The resulting current is not to exceed 20A. If your solar system exceeds this value, contact your dealer for an alternate solar array configuration or suitable controller alternative. Refer to section 4.0.
	<b>Do not exceed GP-MPPT-85/20 max voltage ratings</b>	The voltage rating of the solar array is the sum of the Open Circuit Voltages (Voc) at STC of the PV panels in series, multiplied by 1.25 (or by a value from NEC 690.7 provided in Table 690.7 A). The resulting array Voc voltage is not to exceed 85V. If your solar array exceeds this rating, contact your dealer for an alternate array configuration or suitable controller alternative. PV voltage increases in cold weather. Refer to section 4.0.

## 3.0 Choosing a Location

The GP-MPPT-85/20 is designed to be mounted vertically. Allow at least 2in (5cm) of space around GP-MPPT-85/20 for cooling. Install on non-flammable surface. Do not install in direct sunlight.

The GP-MPPT-85/20 should be:

- Mounted as close to the battery as possible
- Mounted on a vertical surface to optimize cooling of the unit
- In an area with ventilation to dissipate hydrogen gas from batteries as well as heat from the controller

## 4.0 Choosing an Array

The panel voltage should not exceed 85V, or the controller will not charge the batteries. Panel voltage increases in cold weather compared to nameplate standard test condition (STC) ratings, so the highest panel array voltage must be calculated for the worst-case cold weather.

1. Determine the worst-case cold temperature of the panel installation.
2. Select the NEC temperature correction factor matching the worst-case cold temperature of the panel installation. Refer to table 690.7(A) of NEC 2017 or the latest version. When in doubt, select 1.25.
3. Sum the open circuit voltages (Voc) of panels wired in series to obtain the array open circuit voltage at standard test conditions (STC).
4. Multiply the array open circuit voltage by your selected NEC temperature correction factor, or multiply by 1.25 if you don't know which factor to choose.
5. The calculated value must be less than 85V. If not, select a different wiring configuration for the solar panels with fewer in series.

For example, the FLEX-100 has a Voc of 20.8V at STC. If four FLEX-100 solar panels were wired in series, then the array Voc would be 83.2V at STC. If the array were to be used in temperatures down to -40°C, then the NEC temperature correction factor would be 1.25. Multiplying the array Voc by 1.25 is 104V. This is greater than the allowed 85V, and the panels must be wired in a different configuration.

NEC 690.8 defines maximum solar current as the sum of parallel connected PV module short circuit currents (Isc) at STC multiplied by 1.25. This should not exceed 25A. Equivalently, the sum of the short circuit currents before the NEC factor is applied should not exceed the controller nominal current of 20A.

## 5.0 Installation

### 5.1 Tools and Materials Needed

- Philips Screwdriver (for mounting screws)

**NOTE**

If the GP-MPPT-85/20 Controller was purchased with a Go Power! RV Solar Power Kit then UV resistant wire is included. For instructions regarding the Go Power! RV Solar Power Kit installation, please refer to the Installation Guide provided with the Kit.

### 5.2 Instructions

1. **Complete the installation of the solar modules.** If this GP-MPPT-85/20 was purchased as part of a Go Power! Solar Power Kit, follow the Installation Guide provided. Otherwise, follow manufacturer's instructions for solar module mounting and wiring. Keep the solar array covered with an opaque material until all wiring is complete.
2. **Attach temperature sensor ring terminal to battery.** Attach ring terminal to battery lug or use neoprene tape to attach ring terminal to battery case.
3. **Mount the GP-MPPT-85/20.** Mount GP-MPPT-85/20 to a non-flammable surface. Mount vertically for proper heat dissipation.
4. **Select wire type and gauge.** If this GP-MPPT-85/20 was purchased as part of a Go Power! Solar Power Kit, appropriate wire type, gauge and length is provided.

Wire type is recommended to be a stranded copper UV resistant wire. Wire fatigue and the likelihood of a loose connection are greatly reduced in stranded wire compared to solid wire. Wire gauge should be able to sustain rated current and minimize voltage drop.

**IMPORTANT:** All wiring must be in accordance to National Electrical Code, ANSI/NFPA 70.

**IMPORTANT:** Identify the polarity (positive and negative) on the cable used for the battery and solar module. Use colored wires or mark the wire ends with tags. Although the GP-MPPT-85/20 is protected, reverse polarity contact may damage the unit.

5. **Complete battery wiring.** Wire an appropriate fuse or breaker to the battery bank positive terminal. Wire the GP-MPPT-85/20 to the battery bank according to the wiring schematic in **Section 6.0**. Connect negative battery wire directly to the controller, not via the vehicle chassis. With battery power attached, the controller should power up and display LEDs.

Use of a positive or negative distribution bus is allowed between the controller and battery as long as it is properly sized, electrically safe and an adequate wire size is maintained.

**IMPORTANT:** Always use appropriate circuit protection on any conductor attached to a battery.

- Complete solar wiring. Connect the solar wiring to the controller. Then remove the opaque material from the solar array. Connect negative solar array wire directly to the charge controller, not via the vehicle chassis.

Congratulations, your GP-MPPT-85/20 should now be operational. If the battery power is low and the solar array is producing power, your battery should begin to charge.



**WARNING:** This unit is not provided with a GFDI device. This charge controller must be used with an external GFDI device as required by Article 690 of the National Electric Code for the installation location.

## 6.0 Wiring Diagram



**WARNING:** When the photovoltaic (solar) array is exposed to light, it supplies a dc voltage to this equipment

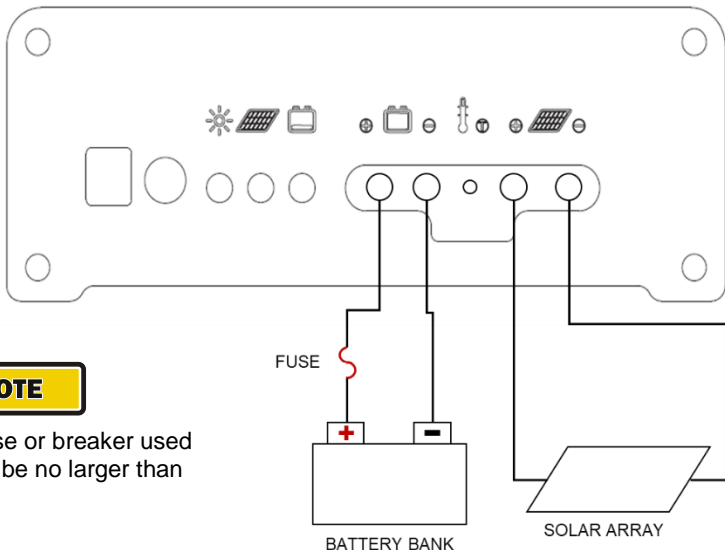

### NOTE

The fuse or breaker used should be no larger than 30A.



## 7.0 Operating Instructions

### 7.1 Battery Charging Profile Chart

**NOTE**

Values before and after the slash correspond to 12 and 24 V systems respectively.



Battery Type	Lead Acid
<b>Float Charge</b> at 25°C:	13.8/27.6V ( $\pm 0.1/0.2V$ )
<b>Bulk/Absorption Charge</b> at 25°C: Set to 30 minutes every morning. Applied for 2 hours if the battery voltage drops below 12.3/24.6 volts.	14.4/28.8V ( $\pm 0.1/0.2V$ )
The term lead acid is a generic battery designation. Choose the charging profile that works best with your battery manufacturer's recommendations.	

### 7.2 LED Display

#### Start Up

When GP-MPPT-85/20 is connected to the battery bank, the controller will start a power up mode which takes several seconds to complete.

#### LED Indicators

LED Icon and Color	LED Status	Indication
 Green	On	Controller connected to battery, night or no PV detected
	Flash	Controller connected to battery, day detected
	Off	Battery connected with reverse polarity or not connected
 Red	On	Charging failure (PV overvoltage or overcurrent)
	Off	Normal charging status
 Red	On	Very low battery voltage or battery overvoltage
	Off	Battery voltage in normal range

The green LED may flash for a few minutes after startup even if no PV is detected. This delay is to avoid erratic day/night transitions.

## 7.3 Switching Between Battery Banks

In some applications, two battery banks with different nominal voltages need charged from the same solar array. An external switch or relay can be used to select which battery bank is charged by the controller.

GP-MPPT-85/20 automatically determines nominal system voltage at startup. If there is a large jump in battery voltage (i.e. switching from one battery bank to another with a different nominal voltage), then the controller will detect the new nominal system voltage and reset.



**WARNING:** Switching must be done with an external device. Each battery bank must have a fuse or breaker. The switching circuit must not allow the battery banks to be connected/shorted.

## 8.0 Frequently Asked Questions (FAQs)

Before a problem is suspected with the system, read this section. There are numerous events that may appear as problems but are in fact perfectly normal. Please visit [gpelectric.com](http://gpelectric.com) for the most up-to-date FAQs.

### **It seems like my flooded batteries are losing water over time.**

Flooded batteries may need to have distilled water added periodically to replace fluid loss during charging. Excessive water loss during a short period of time indicates the possibility of overcharging or aging batteries.

### **When charging, my flooded batteries are emitting gas.**

During charging, hydrogen gas is generated within the battery. The gas bubbles stir the battery acid, allowing it to receive a fuller state of charge.

**IMPORTANT:** Ensure batteries are in a well-ventilated space.

## 9.0 Troubleshooting Problems

### **How to Read this Section**

*Troubleshooting Problems* is split into four sub-sections, grouped by symptoms involving key components. Components considered irrelevant in a diagnosis are denoted 'Not Applicable' (N/A). A multimeter or voltmeter may be required for some procedures listed.

Check the controller LED display as the first step.

### **NOTE**

It is imperative all electrical precautions stated in the Safety Instructions and outlined in the Installation Section are followed. **Even if it appears the system is not functioning, it should be treated as a fully functioning system generating live power.**

## 9.1 *Blank LED Display*

**Display Reading:** Blank (no LEDs)

**Time of Day:** Daytime/Nighttime

**Possible Causes:**

Battery voltage or connection, blown fuse/breaker, wiring/connector problems

**How to tell:**

1. Check the battery voltage. If battery voltage is  $<9V$ , the controller will not charge, and the LEDs may not function correctly.
2. Check wiring polarity.
3. Check all fuses/breakers, wires, and connections. A blown fuse/breaker, damaged wire, or loose connection will prevent battery power from reaching the controller.

**Remedy:**

1. Use an external charging source to charge the battery voltage above 9V. Consider battery replacement.
2. Correct any reverse polarity connections.
3. Check that all connections are clean, tight, and secure. Check that all wires and insulation are intact. Check for possible shorts or damaged equipment. Replace blown fuses or reset breakers.

## 9.2 *Red Battery LED On*

**Display Reading:** Red battery LED on

**Time of Day:** Daytime/Nighttime

**Possible Cause:**

1. Battery voltage is too low because of excessive voltage drop from battery bank to controller or insufficient solar power.
2. Battery voltage is too low because of excessive load power draw from battery bank.
3. Battery voltage is too high because of secondary charging source.
4. Battery voltage is too high because of a short.

**How to tell:**

Check the battery bank voltage with a voltmeter. Less than 11.9/23.8V is a low battery voltage. Above 15.5/31.0V is a high battery voltage.

Check the battery voltage when loads are on and recheck when loads are off. If there is a voltage discrepancy of more than 1V, the loads may be too large.

**Remedy:**

1. Check all wiring and connections from the controller to the battery bank. Ensure that all connections are clean, tight, and secure. Shorten the distance from the controller to battery bank or obtain larger wire. It is also possible to double up the existing gauge wire (i.e. two wire runs) to simulate a larger wire. Wait for system to charge battery. Turn off loads for faster charging.
2. Increase the battery bank capacity. Consult your dealer or installer for assistance.
3. Remove any secondary charging source. GP-MPPT-85/20 will only begin charging after battery voltage has fallen to a normal level. Use a voltmeter to check if voltages are in correct range.
4. De-energize system and disconnect equipment. Use a DMM with a connectivity setting to check for shorts in wiring or equipment. Otherwise, use a voltmeter to check if voltages are in correct range.

### 9.3 *Red Solar LED On*

**Display Reading:** Red solar LED on

**Time of Day:** Daytime/Nighttime

**Possible Cause:**

1. PV array voltage is greater than 85V.
2. PV array current is greater than 20A.

**How to tell:**

Measure PV array voltage. If it's greater than 85V, the controller will not charge. Check PV module nameplate for ratings.

**Remedy:**

Change PV array wiring configuration. Consult your dealer or installer for assistance.

### 9.4 *Problems with Charging*

**Problem:** Controller doesn't seem to be charging

**Time of Day:** Daytime, clear sunny skies

**Possible Cause:**

Current is being limited as per normal operation or poor connection between solar array and controller.

**How to tell:**

The green LED will flash if controller is charging. The green LED is on continuously if controller isn't charging or if there's insufficient solar voltage.

With the solar array in sunlight, check the voltage of the solar array terminals with a voltmeter.

**Remedy:**

Check all connections from the controller to the array including checking for correct wire polarity. Check that all connections are clean, tight, and secure.

Wait 5 minutes and recheck charging status. A delay is present to prevent erratic behavior.

**Problem:** Charge current is less than expected

**Time of Day:** Daytime, clear sunny skies

**Possible Causes:**

1. Current is being limited as per normal operation.
2. Incorrect series/parallel configuration and/or wiring connections and/or wire gauge.
3. Dirty or shaded module or lack of sun.
4. Blown diode in solar module when two or more modules are connected in parallel.

**How to tell:**

1. Check battery voltage. If battery has reached the target charge voltage, then current is being limited per normal operation.
2. Check the heatsink temperature. Controller will limit charge current when internal temperatures are too high.
3. Check that the modules and batteries are configured correctly. Check all wiring connections.
4. Modules look dirty, overhead object is shading modules or it is an overcast day in which a shadow cannot be cast.

**NOTE**

Avoid any shading no matter how small. An object as small as a broomstick held across the solar module may cause the power output to be reduced. Overcast days may also cut the power output of the module.

**Remedy:**

Reconnect in correct configuration. Tighten all connections. Check wire gauge and length of wire run.

Clean modules, clear obstruction or wait for conditions to clear.

If the open circuit voltage of a module is lower than the manufacturer's specifications, the module may be faulty. Check for blown diodes in the solar module junction box which may be shorting the power output of module.

## 10.0 Limited Warranty

GoPower warrants the GP-MPPT-85/20 for a period of five (5) years from the date of shipment from its factory. This warranty is valid against defects in materials and workmanship for the five (5) year warranty period. It is not valid against defects resulting from, but not limited to:

- Misuse and/or abuse, neglect, or accident
- Exceeding the unit's design limits
- Improper installation, including, but not limited to, improper environmental protection and improper hook-up
- Acts of God, including lightning, floods, earthquakes, fire, and high winds
- Damage in handling, including damage encountered during shipment

This warranty shall be considered void if the warranted product is in any way opened or altered. The warranty will be void if any eyelet, rivets, or other fasteners used to seal the unit are removed or altered, or if the unit's serial number is in any way removed, altered, replaced, defaced, or rendered illegible.

### 10.1 *Repair and Return Information*

Visit [www.gpelectric.com](http://www.gpelectric.com) to read the "frequently asked questions" section of our website to troubleshoot the problem. If trouble persists:

1. Call your Go Power!® Technical Support team (1-866-247-6527).
2. Return defective product to place of purchase.





© 2019 GO POWER!® By Valterra Products, LLC

GP-MPPT-85/20\_Manual\_revA

*gp*electric.com