

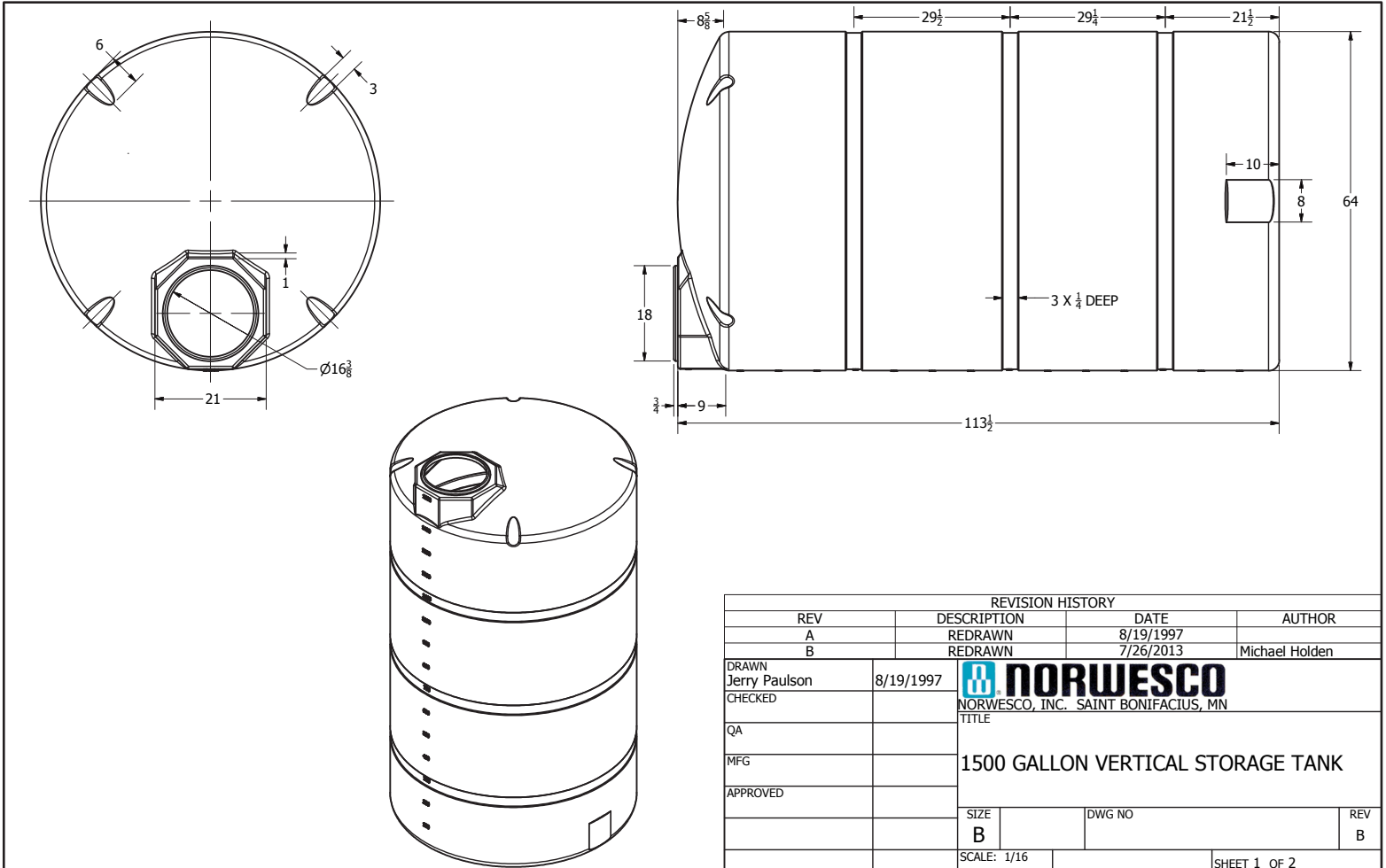

if it flows,  
we go with it

1.800.665.4499  
barrplastics.com



REVISION HISTORY			
REV	DESCRIPTION	DATE	AUTHOR
A	REDRAWN	8/19/1997	
B	REDRAWN	7/26/2013	Michael Holden
DRAWN Jerry Paulson		8/19/1997	 NORWESCO, INC. SAINT BONIFACIUS, MN
CHECKED			
QA			TITLE
MFG			1500 GALLON VERTICAL STORAGE TANK
APPROVED			
SIZE B		DWG NO	REV B
SCALE: 1/16		SHEET 1 OF 2	