

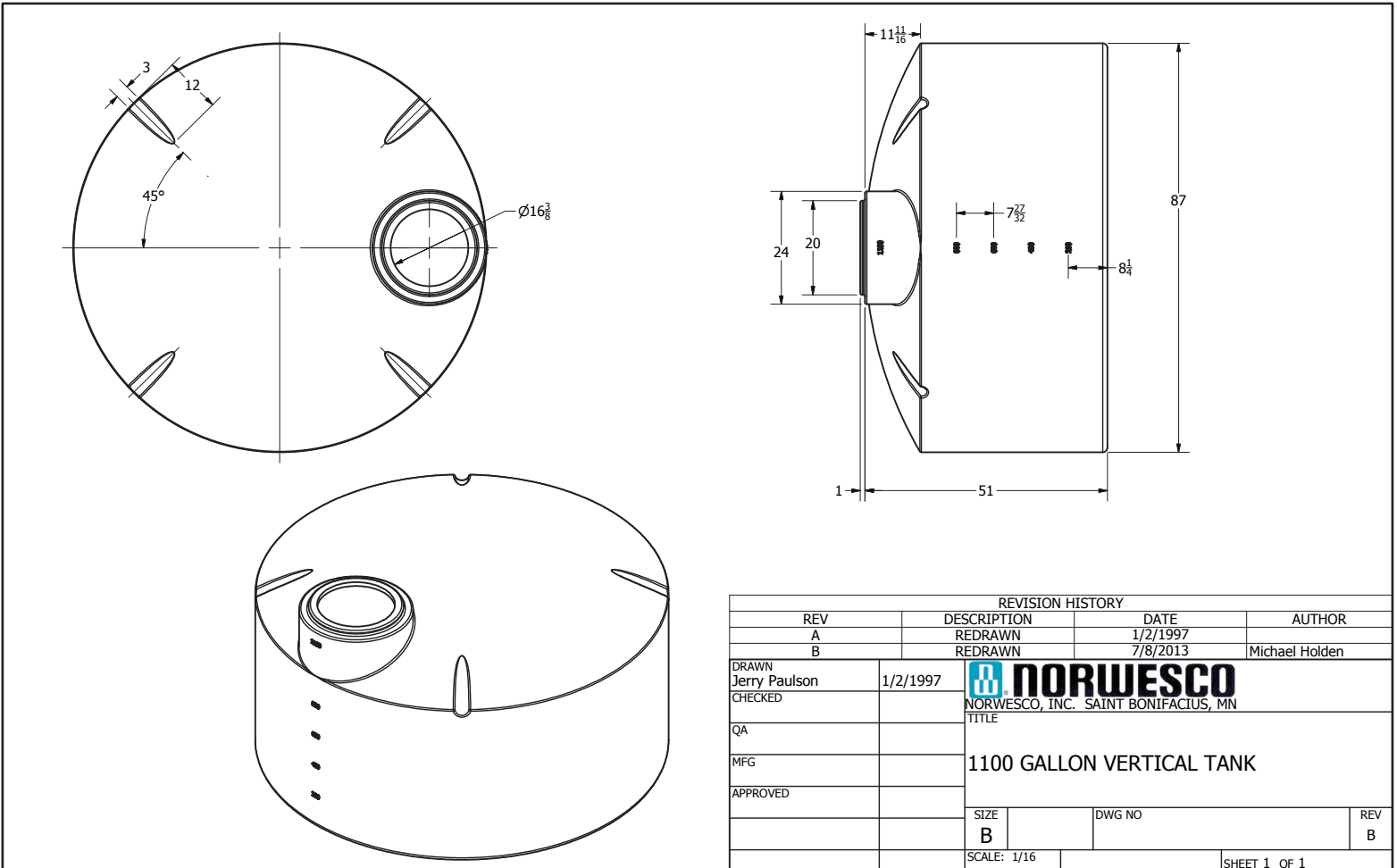

if it flows,  
we go with it

1.800.665.4499  
barrplastics.com



REVISION HISTORY			
REV	DESCRIPTION	DATE	AUTHOR
A	REDRAWN	1/2/1997	
B	REDRAWN	7/8/2013	Michael Holden

DRAWN Jerry Paulson	1/2/1997	 NORWESCO, INC. SAINT BONIFACIUS, MN	
CHECKED			
QA		TITLE	
MFG		1100 GALLON VERTICAL TANK	
APPROVED			
	SIZE B	DWG NO	REV B
	SCALE: 1/16	SHEET 1 OF 1	