

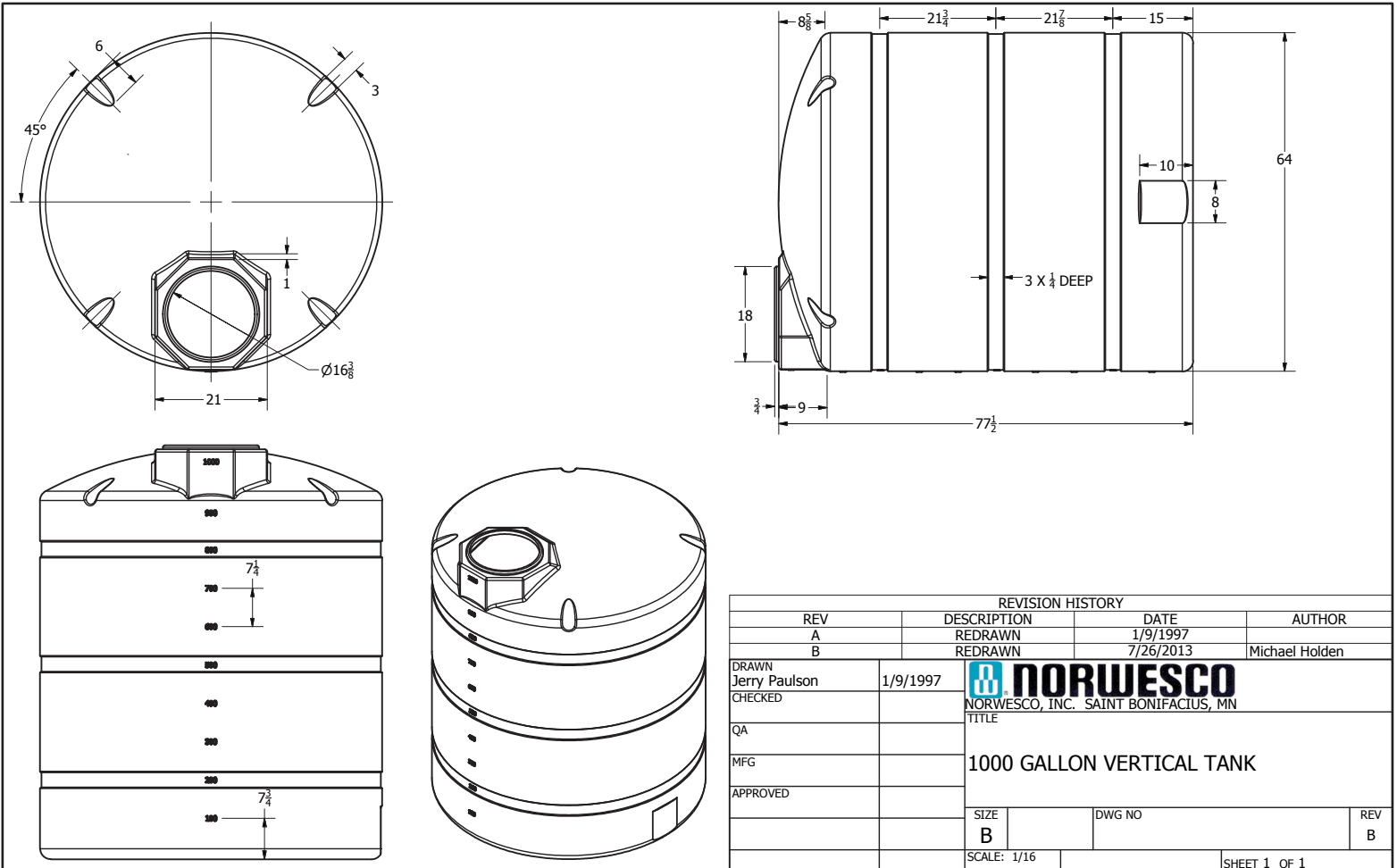

if it flows,
we go with it

1.800.665.4499
barrplastics.com



| REVISION HISTORY | | | |
|------------------|-------------|-----------|----------------|
| REV | DESCRIPTION | DATE | AUTHOR |
| A | REDRAWN | 1/9/1997 | |
| B | REDRAWN | 7/26/2013 | Michael Holden |

| | | | |
|------------------------|-------------|---|----------|
| DRAWN Jerry Paulson | 1/9/1997 | NORWESCO, INC. SAINT BONIFACIUS, MN | |
| CHECKED | | | |
| QA | | TITLE | |
| MFG | | 1000 GALLON VERTICAL TANK | |
| APPROVED | | | |
| | SIZE B | DWG NO | REV B |
| | SCALE: 1/16 | SHEET 1 OF 1 | |