

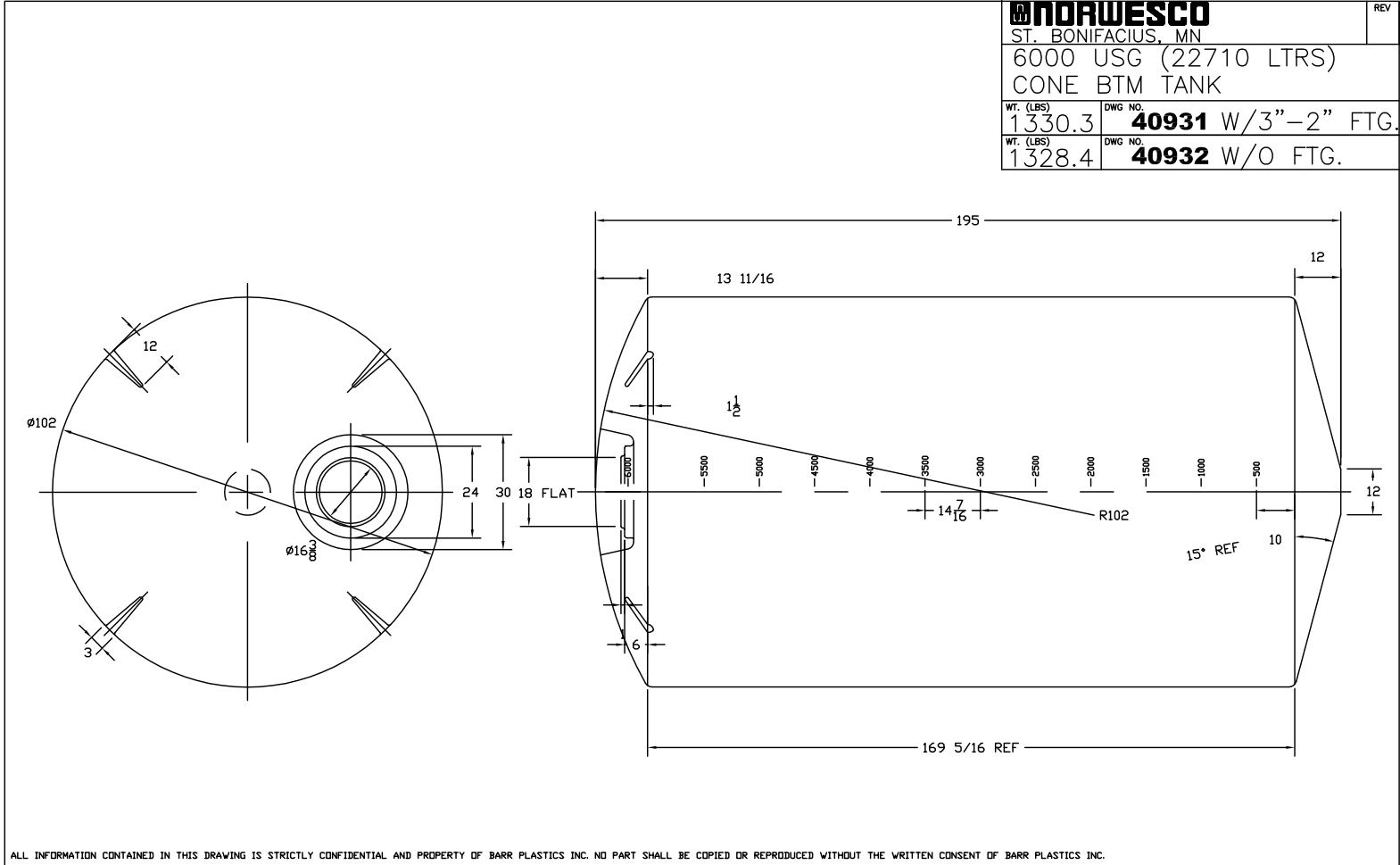

if it flows,
we go with it

1.800.665.4499
barrplastics.com



ALL INFORMATION CONTAINED IN THIS DRAWING IS STRICTLY CONFIDENTIAL AND PROPERTY OF BARR PLASTICS INC. NO PART SHALL BE COPIED OR REPRODUCED WITHOUT THE WRITTEN CONSENT OF BARR PLASTICS INC.

Customer Drawing Approval

Customer _____

Barr Plastic Inc. _____

H:\BPT SALES DWG\TANKS Norwesco_Snyder_Ace\Norwesco\Cone Bottom Tanks\6000.DWG



DATE: 18 AUG 05

PROJECT:
- TANK APPROVAL DWG

CLIENT:
-

DRAWING REF:
-

SCALE:
-

REV:
-

MATERIAL SPECIFICATIONS

HDPE 1.5 SPG

ALL FITTINGS ARE
POLYPROPYLENE WITH
EPDM GASKETS