

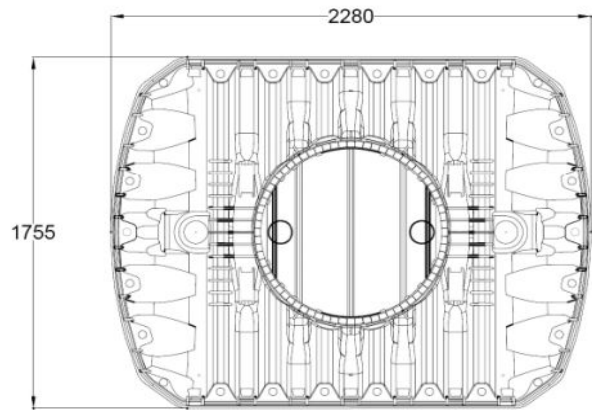

if it flows,
we go with it

1.800.665.4499
barrplastics.com

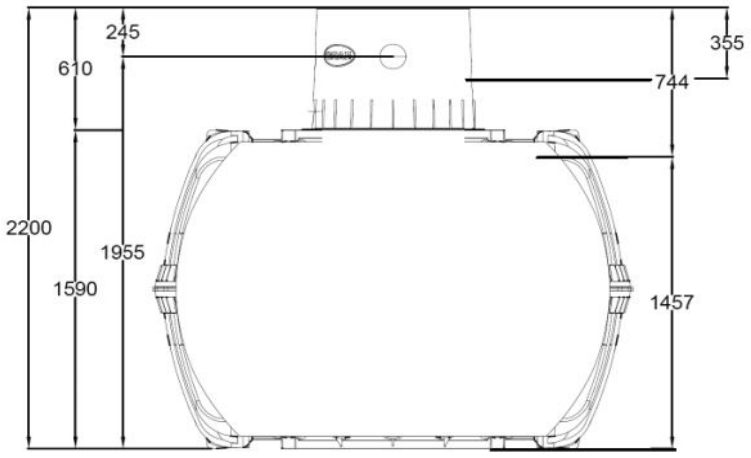
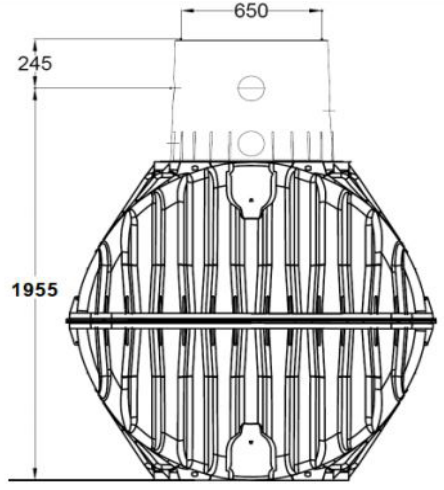

ACCEPTANCE (SIGN & DATE)	DATE		TITLE GRAF CARAT S – BG TANK – 3750 L 1000 USG / 840 IG		
CUSTOMER NAME - PRINT:			DRAWN BY:	EFFECTIVE DATE: 10/03/10	PROJECT:
			CHECKED:	DRAW NG NO.:	REVISION: NTS

This document contains proprietary information. It is intended solely for use of potential clients involved or to be involved in a transaction with BARR Plastics Inc. Such proprietary information may not be used, reproduced, or disclosed for any other purpose without the expressed written permission.

© 2019 BARR PLASTICS INC