

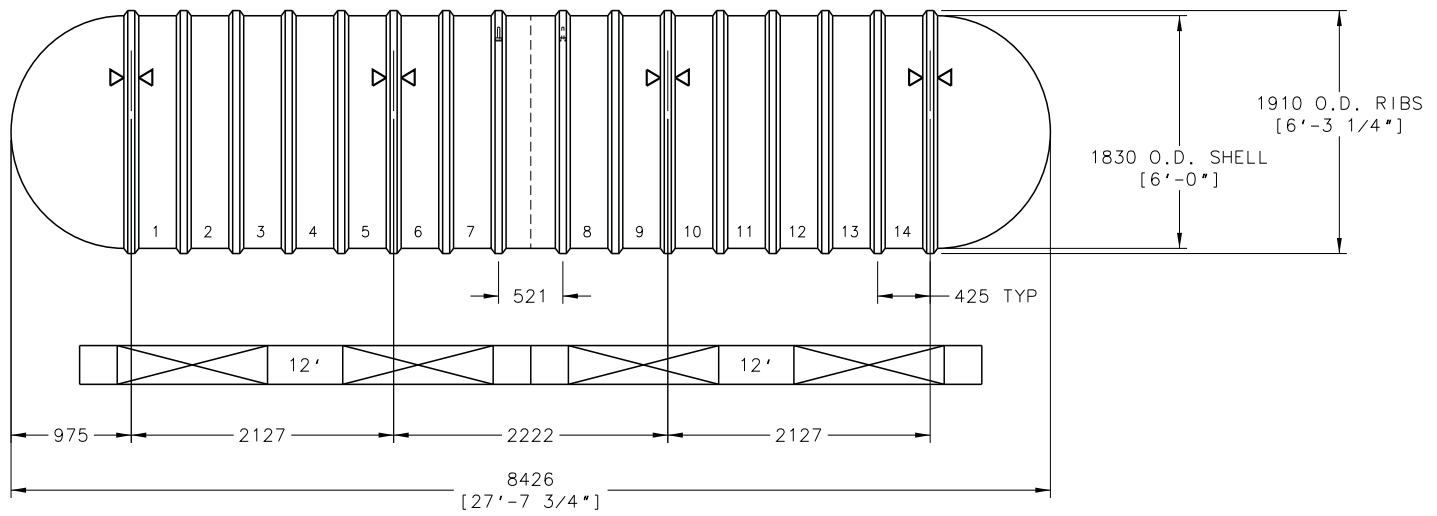

if it flows,
we go with it

1.800.665.4499
barrplastics.com



Optional prefabricated engineered concrete deadmen shown.

ZCL COMPOSITES INC.	
TITLE Z60SW CAP. 20,000 LITRES 5,000 U.S. GALLONS	
DATE 6-12	DR. NO. Z10-007.01