

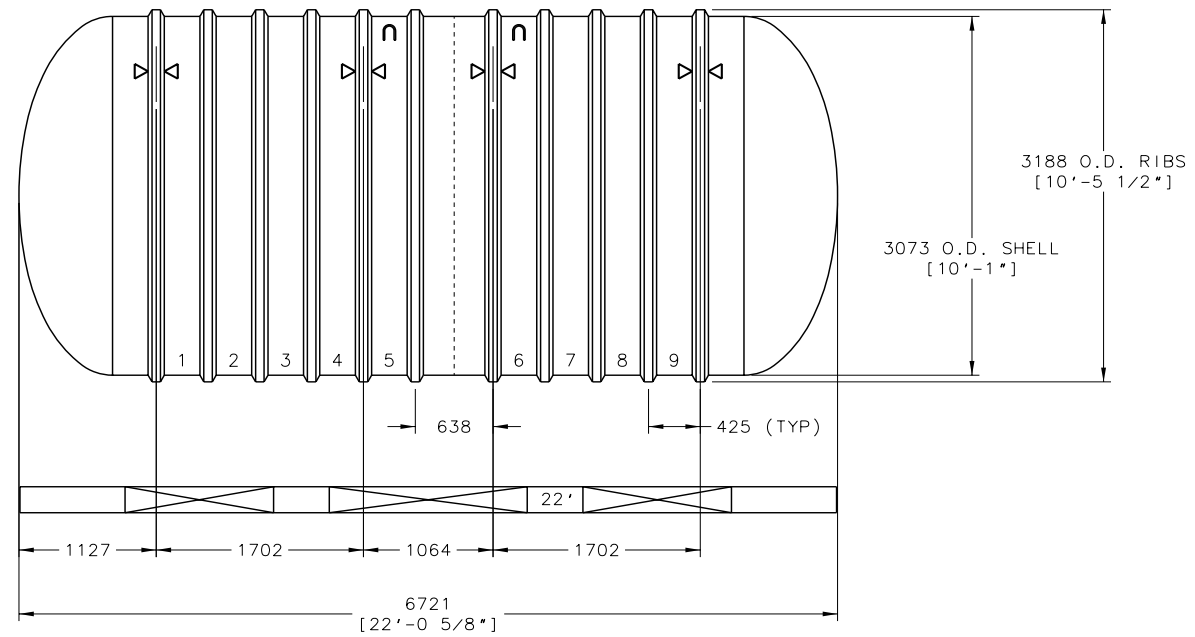

if it flows,  
we go with it

1.800.665.4499  
barrplastics.com



Optional prefabricated engineered concrete deadmen shown.

<b>ZCL</b> COMPOSITES INC.	
TITLE Z100SW CAP. 45,000 LITRES 12,000 U.S. GALLONS	
DATE 6-12	DR. NO. Z10-023.01