



if it flows,
we go with it

1.800.665.4499
barrplastics.com

Dock Accessories

External Square Dock Pile Guides

Designed for holding pilings attached to the outside of your dock, our external square pile guides are hot dipped galvanized after fabrication and are available in several models. All are made from 2" tubing and include four 6" rollers and a deck plate that can mount right to your dock frame.

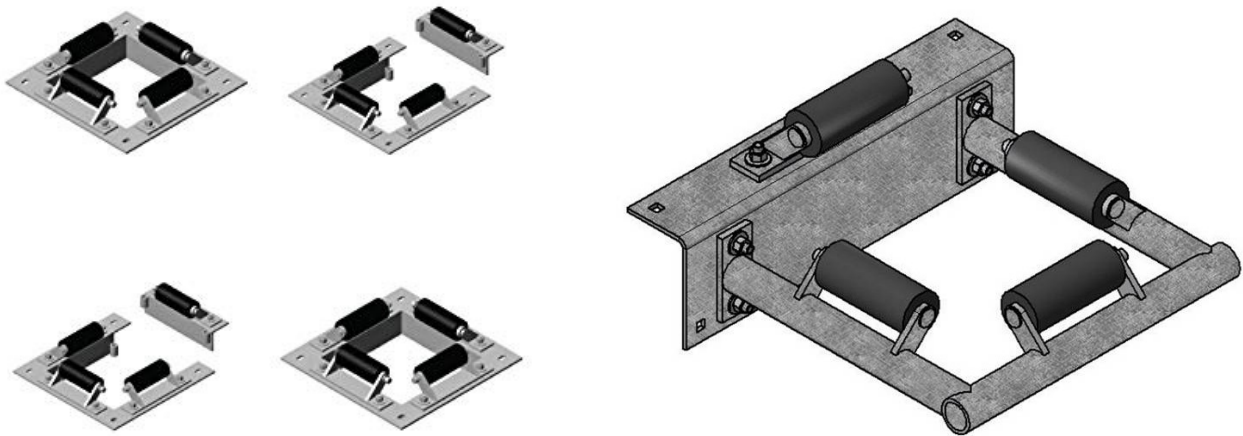

Part #	Description	Size (in)
PH-10EX	External Square Pile Guide-Complete	8
PH-12EX	External Square Pile Guide-Complete	10
PH-14EX	External Square Pile Guide-Complete	12
PH-16EX	External Square Pile Guide-Complete	14
PH-18EX	External Square Pile Guide-Complete	16
H-RA	Roller Assembly	6



if it flows,
we go with it

1.800.665.4499
barrplastics.com

Complete External Square Assemblies

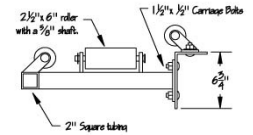
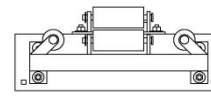
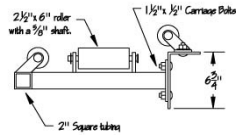
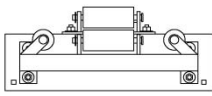
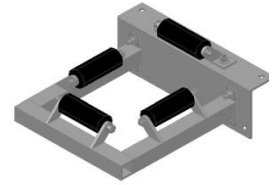
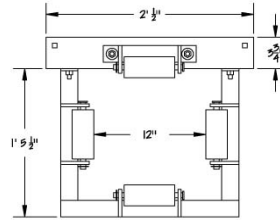
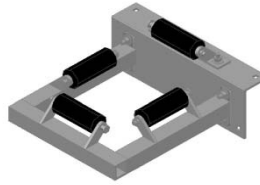
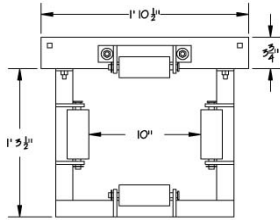

PH-10EX

10" External Square Pipe Hoop Assembly
Hardware Detail

PH-12EX

12" External Square Pipe Hoop Assembly
Hardware Detail

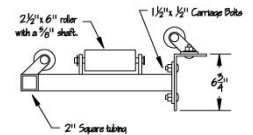
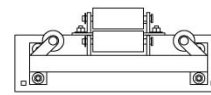
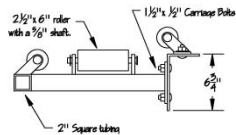
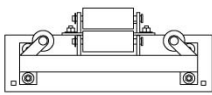
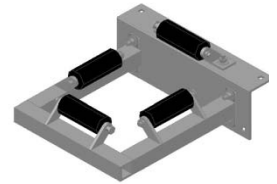
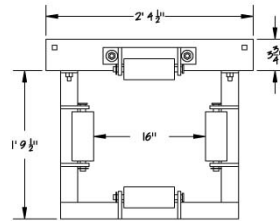
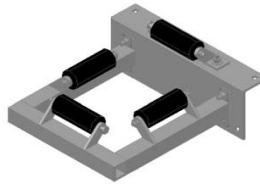
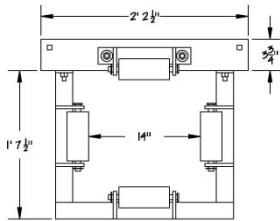

PH-14EX

14" External Square Pipe Hoop Assembly
Hardware Detail

PH-16EX

16" External Square Pipe Hoop Assembly
Hardware Detail

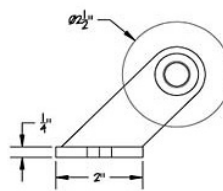
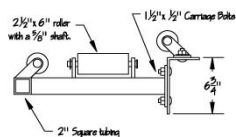
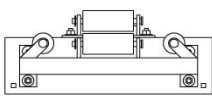
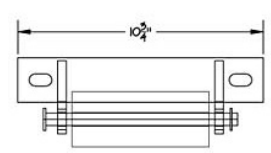
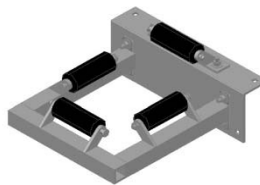
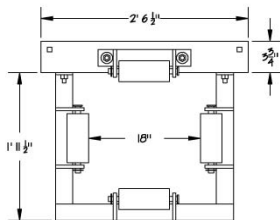

PH-18EX

18" External Square Pipe Hoop Assembly
Hardware Detail

H-RA