

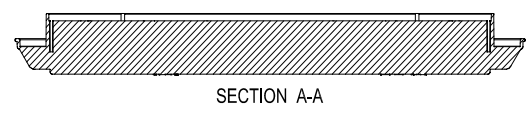

if it flows,
we go with it

1.800.665.4499
barrplastics.com



SECTION A-A

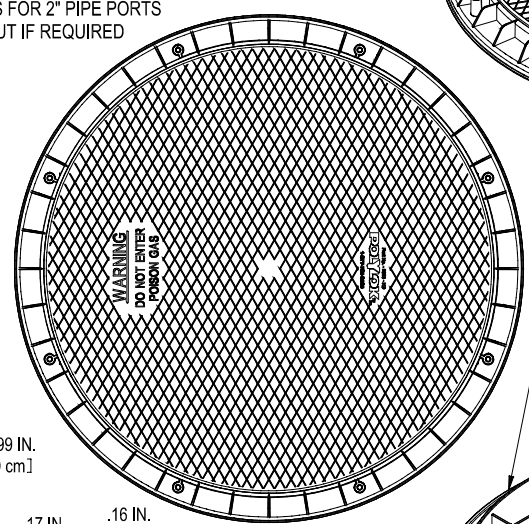
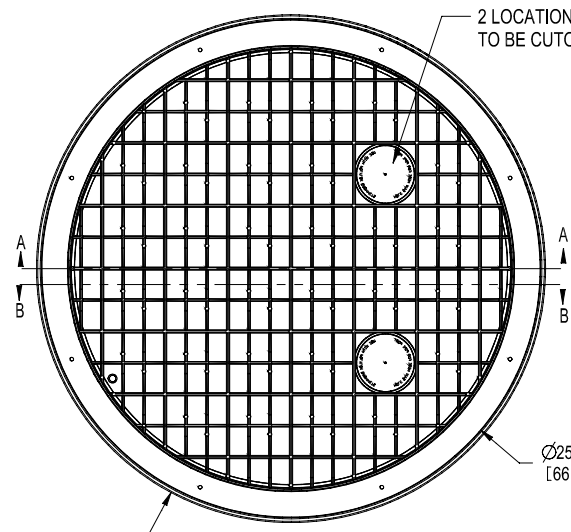
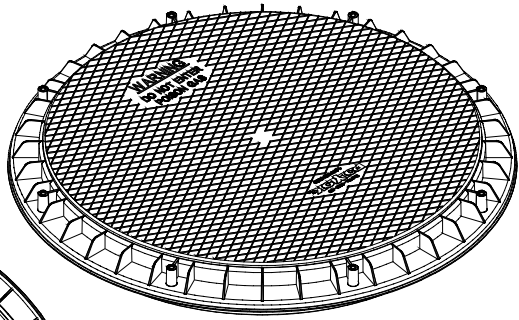

BOTTOM DETAIL FITS POLYLOK
PART NO. - 3008
3008-R12
3008-R12B
3009-AR
3009-RTR24
3008-RP
AND ALL 24\"/>

EPDM FOAM GASKET
INSTALLED HERE

Ø26.52 IN.
[67.4 cm]

Ø25.99 IN.
[66.0 cm]

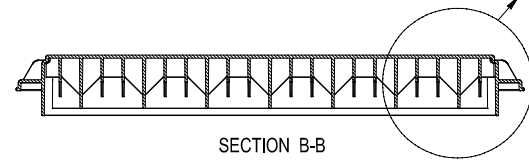
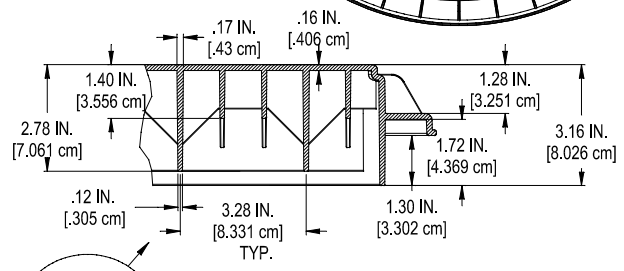

SECTION B-B

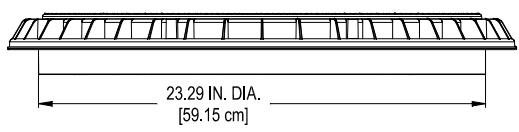

POLYLOK 24\"/>
PART NO. 3008-HD
MATERIAL - HDPE
COLOR - GREEN