

# GRIFFIOEN.

## STATEMENT RE PROVISION OF INFORMATION

The attached material has been compiled by the collection of records, documents, or information which may have been supplied by third parties, the vendor or the vendor's agent. GRIFFIOEN. (Powered by Ownly Limited, Licensed REAA 2008) is merely passing over this information as supplied to us.

We cannot guarantee its accuracy as we have not checked, audited, or reviewed the information and all intending purchasers are advised to seek their own advice as to the information contained in this document.

To the maximum extent permitted by law we do not accept any responsibility to any party for the accuracy or use of the information herein.

# Code Compliance Certificate

*Section 95, Building Act 2004*

*Form 7 – Building (Forms) Regulations 2004*

<b>Building consent number</b>	BCN/2024/4875	<b>Date issued</b>	8 August 2024
<b>The building</b>			
<b>Street address of building</b>	241 Lake Terrace Road Shirley	<b>Location of building within site/block number</b>	
<b>Legal description of land where building is located</b>	Lot 13 DP 14188		
<b>Building name</b>		<b>Level/unit number</b>	
<b>Year first constructed</b>	Circa 1960's	<b>Current, lawfully established use</b>	Housing - Dwelling

## The owner

<b>Name of owner</b>	O M Aitken and B C Harris and N M Aitken and M W Harris	<b>Phone number</b>	
<b>Contact person</b>	Olivia Aitken	<b>Landline</b>	
<b>Mailing address</b>	241 Lake Terrace Road Christchurch 8061	<b>Mobile</b>	██████████
<b>Street address/ registered office</b>	241 Lake Terrace Road Christchurch 8061	<b>Daytime</b>	
<b>Email address</b>	████████████████████	<b>After hours</b>	
		<b>Fax</b>	
		<b>Website</b>	

First point of contact for communications with the building consent authority:

<b>Name</b>	O M Aitken	<b>Phone</b>	
<b>Contact person</b>	Olivia Aitken	<b>Mobile</b>	██████████
<b>Mailing address</b>	241 Lake Terrace Road Christchurch 8061	<b>Fax</b>	
		<b>Email address</b>	████████████████████

## Building work

Building consent number **BCN/2024/4875**

**Alteration to dwelling - installation of Metro Ultra Tiny Rad, freestanding, dry, woodburner, CAC 210657**

Issued by: Christchurch City Council

## Code compliance

The Christchurch City Council is satisfied, on reasonable grounds, that the building work complies with the building consent.

*Lorraine Wilson*

Code Compliance Assessor  
Building Compliance  
Phone 03 941 6634  
lorraine.wilson@ccc.co.nz

On behalf of: Christchurch City Council

Date: 8 August 2024

14.8m approx

9.8m approx

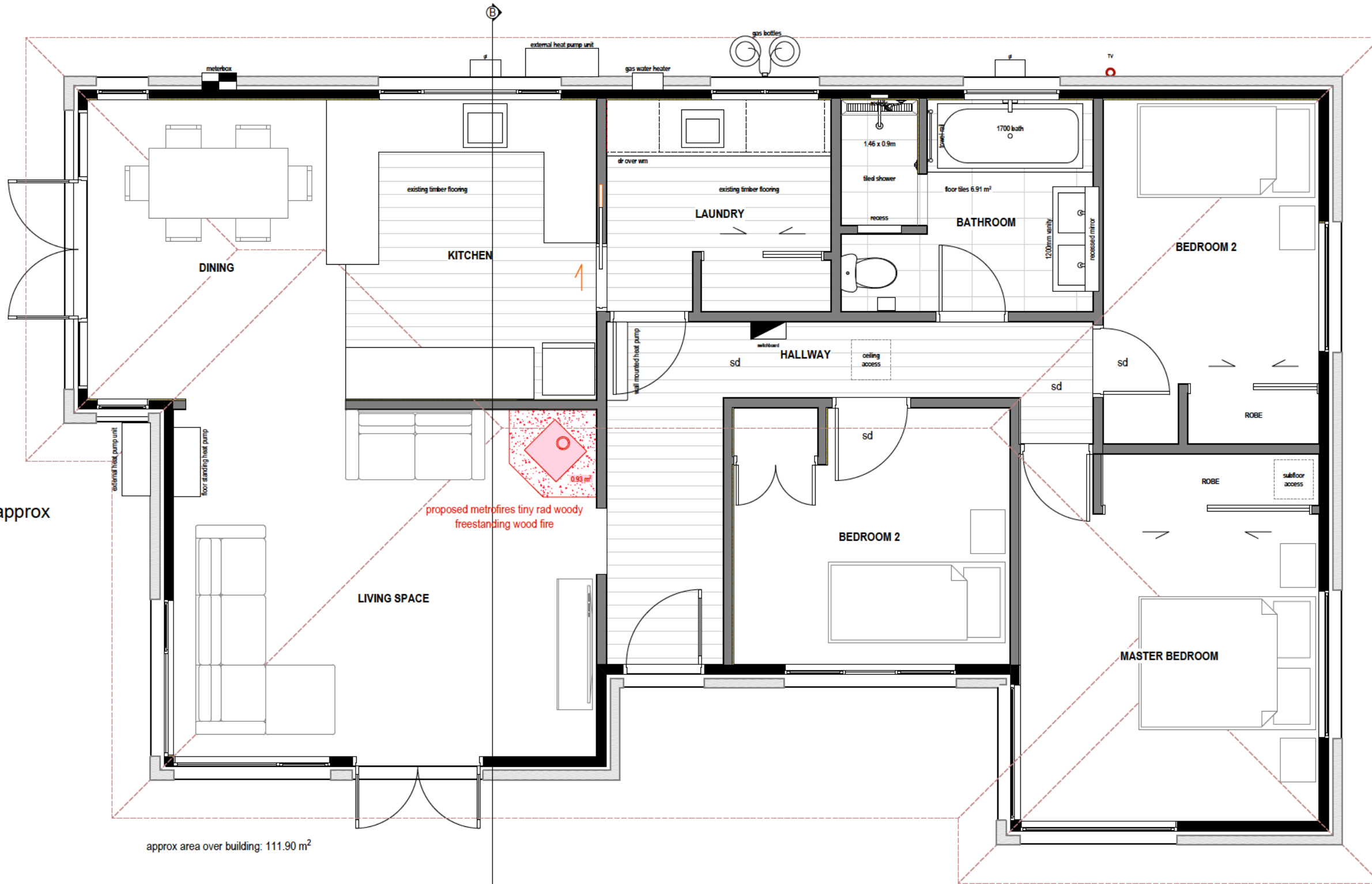

oma | architecture

omaarchitecture@gmail.com

project

# HARRIS FIRE INSTALLATION

drawing

## FLOOR PLAN

project address

Lot 13 DP 14188, 241 Lake Terrace Road, Shirley, Christchurch

disclaimer: this project has been designed for the client and remains copyrighted to OMA architecture Ltd. All dimensions, materials, and timber treatments are to be confirmed prior to construction. All work must be in accordance with the NZ Building Code, and relevant NZ Standards whether referenced in this documentation or not, (including but not limited to Foundation & Timber Frame Construction, Timber Treatment NZS3602 2003). The position of all services to site must be confirmed prior to construction. Soffit, lintel, and ceiling heights may vary. Designer should be consulted rather than assume a certain height if it can not be ascertained from specific cross sections.

job number 2426

date of issue 01/06/2024

status consent

scale 1:50

revision 26/06/2024

version v1

sheet 1



Wall clearances

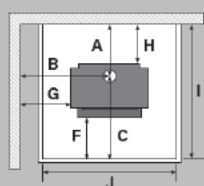

Corner clearances

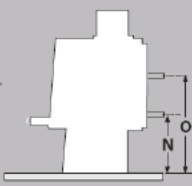
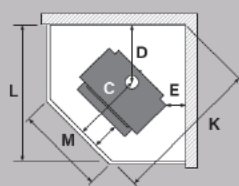

Minimum installation clearances with a Pioneer flue shield fitted (mm)

	A	B	C	D	E	F	G	H	I	J	K	L	M
	251	568	580	382	110	232	310	100	831	650	1120	870	250

Model	Width	Depth	Height	N	O
Dimensions	515mm	498mm	758mm	365mm	555mm

Specifications were correct at the time of printing but may alter and those detailed should be used only as a guide. If in doubt, please consult your local Metro Fires stockist. Peak heat outputs (kW) are based on the NZHHA test method using dry pine with testing undertaken by independent International Accredited New Zealand (IANZ) testing facilities.



**Figure 54: Soaker flashing for pipe penetrations**  
Paragraph 8.4.17

NOTE: (1) Suitable for pipes from 86 mm to 500 mm diameter.  
(2) Suitable only for roof pitches of 10° or more.

Soaker flashing to be fully supported by roofing under - refer Figure 21

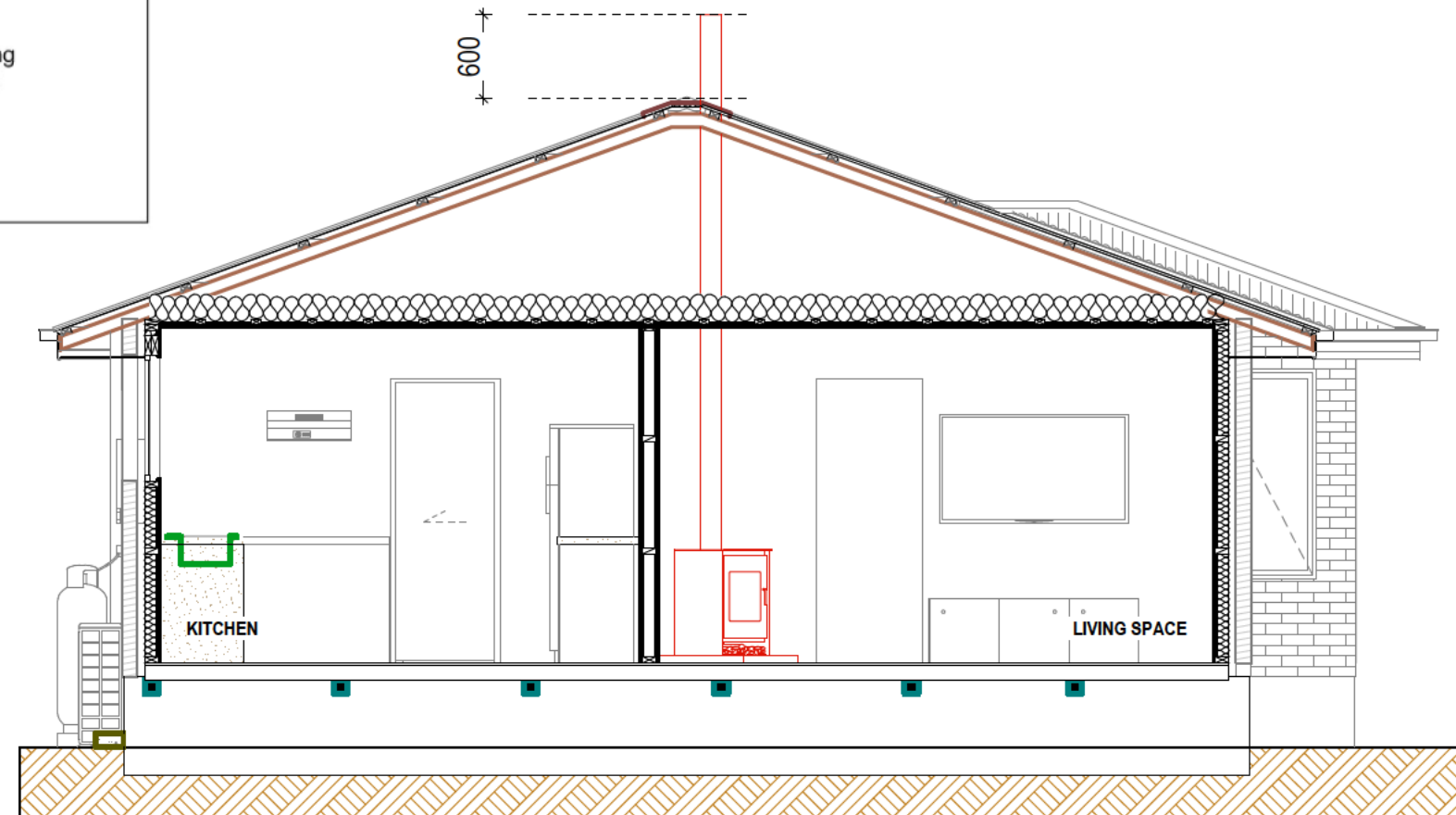
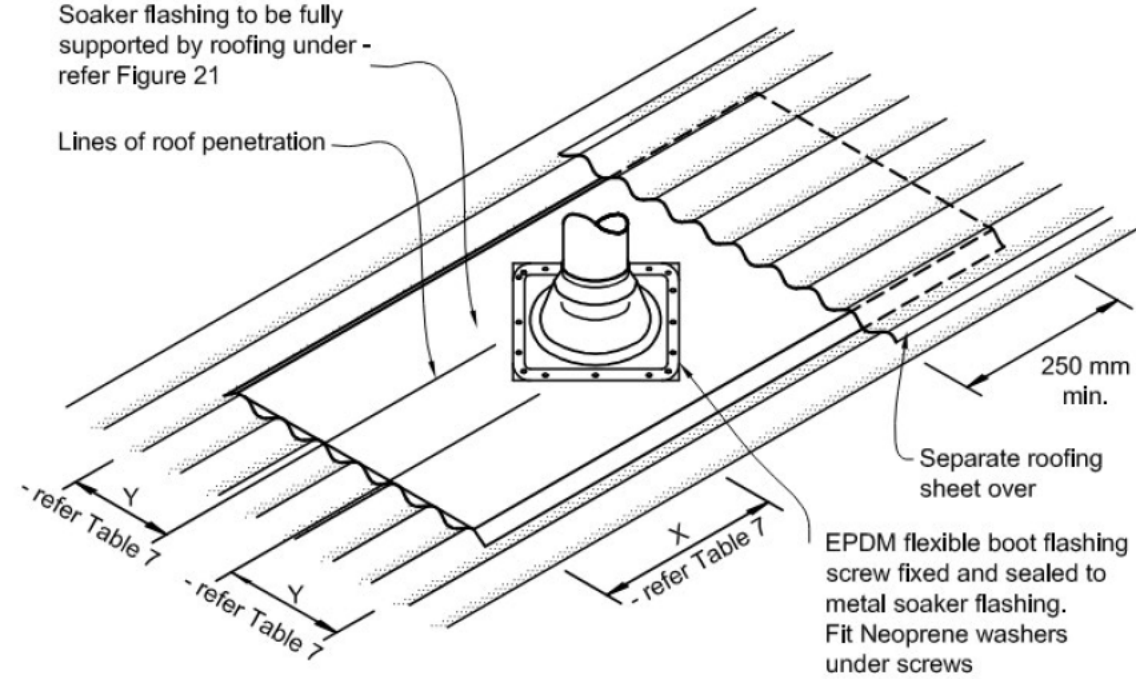
Lines of roof penetration



 omaarchitecture@gmail.com	project	drawing	project address	<small>disclaimer: this project has been designed for the client and remains copyrighted to OMA architecture Ltd. All dimensions, materials, and timber treatments are to be confirmed prior to construction. All work must be in accordance with the NZ Building Code, and relevant NZ Standards whether referenced in this documentation or not, (including but not limited to Foundation &amp; Timber Frame Construction, Timber Treatment NZS3602:2003). The position of all services to site must be confirmed prior to construction. Soffit, lintel, and ceiling heights may vary. Designer should be consulted rather than assume a certain height if it can not be ascertained from specific cross sections.</small>	job number	scale	sheet <b>2</b> 
	<b>HARRIS FIRE          INSTALLATION</b>	<b>CROSS SECTION A</b>	Lot 13 DP 14188, 241 Lake Terrace Road, Shirley, Christchurch		2426	1:50	
					date of issue	revision	
					01/06/2024	26/06/2024	
status	version	consent	v1				

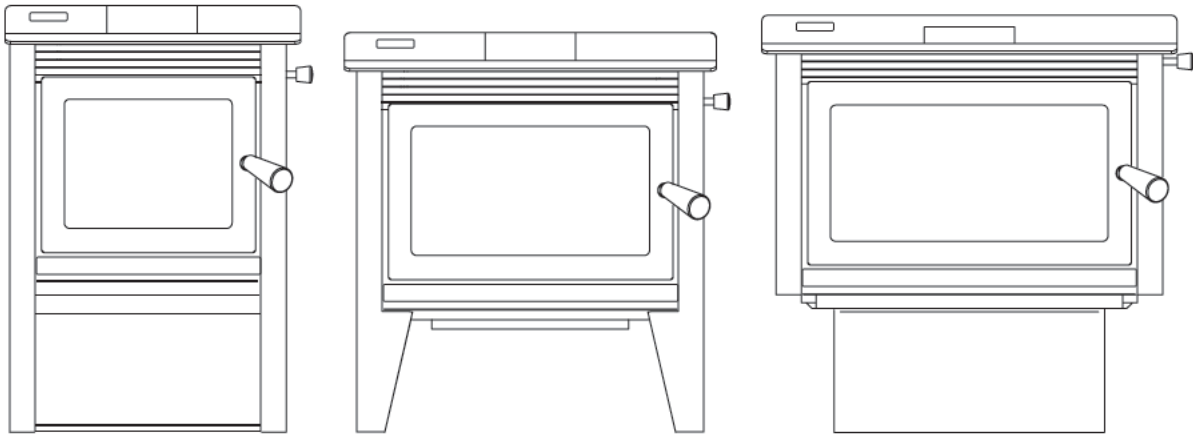

metrofires

# FREESTANDING WOOD FIRES

## Wood fire installation and operation manual

Important installation information.....	2	Getting to know your Metro fire.....	9
Assembling your Metro fire.....	2	Operating your Metro fire.....	9
Floor protectors.....	4	Cleaning and maintenance .....	10
Flue installation .....	5	Troubleshooting .....	12
Wetback installation.....	6	Metro Fires warranty .....	13
Clearances and specifications .....	7	Replacement parts.....	14
Important operation information.....	8		

## IMPORTANT INSTALLATION INFORMATION

All Metro freestanding fires have been tested and approved to AS/NZS 2918 with a ceiling height of 2.4m (+/-0.1m) with a Pioneer double flue shield fitted.

All Metro fires comply with AS/NZS 2918 when installed in accordance with this manual. Please ensure you are fully conversant with the relevant Standard and the full contents of this manual.

Correct installation is critical to the safe operation and performance of this wood fire. Please take particular note of the following:

- It is recommended that Metro fires be installed with a Metro ECO flue system which has been developed to enhance the performance of Metro wood fires. Any alternative flue system must have a minimum flue pipe length of 4.2 metres of 150mm diameter flue pipe and have been tested to AS/NZS 2918 with a 12mm spaced ceiling plate of no less than 345mm square
- The 150mm active flue pipe must be fully encased from the ceiling to the underside of the flashing cone at the top of the flue system, (i.e. there must not be any 150mm flue pipe exposed)
- All flue pipe joints must be sealed and riveted. The bottom of the flue pipe in particular **MUST** be fully sealed into the flue outlet of the Metro fire
- The Metro fire must be bolted through the floor protector into the floor to comply with the seismic restraint provisions of AS/NZS 2918
- All Metro's are extremely heavy, varying in weight from 75kgs up to 185kgs. During the installation process **DO NOT** lift the appliance by yourself, and take care not to damage the panel coating
- Take care when lifting the fire into place onto the hearth or floor protector as point loading may break tiles and/or scratch surfaces

### **WARNING! Important Information**

WE HIGHLY RECOMMEND YOU READ THIS ENTIRE MANUAL AS INCORRECT OPERATION, MISUSE AND/OR LACK OF MAINTENANCE WILL VOID THE WARRANTY

- The appliance and flue-system shall be installed in accordance with AS/NZS 2918 and the appropriate requirements of the relevant building code or codes
- Any modification of the appliance that has not been approved in writing by the testing authority is considered to be in breach of the approval granted for compliance with AS/NZS 4013 and will void the warranty
- The appliance must be installed correctly. We recommend a competent and suitably qualified NZHHA installer

### **CAUTION! Important Information**

- Mixing of appliance or flue-system components from different sources or modifying the dimensional specification or components may result in hazardous conditions. Where such action is considered, the manufacturer should be consulted in the first instance
- **DO NOT** install a Metro fire if there is any sign of visible damage to the product
- This appliance must be regularly maintained.
- Use authorised Metro replacement parts only. The use of unauthorised parts may void the warranty
- This manual **MUST** be left with the home owner

## ASSEMBLING YOUR METRO FIRE

Note: You should only assemble this wood fire if you are suitably experienced in wood fire assembly and installation. The Metro carton shows the model Metro you are about to install, enabling you to select the appropriate model's assembly instructions.

All Metro wood fires are packed in a single heavy-duty carton, and tek screwed to a wooden pallet. Having removed the packaging and located this manual, familiarise yourself with the illustrations on pages 2 and 3, and proceed as follows:

### Metro radiant fires

These Metro's are supplied virtually fully assembled. Packed inside the firebox you will find bricks in a cardboard wrapper, a door handle and air control knob.

- Remove the two tek screws which secure the Metro fire to the wooden pallet and carefully lift the fire off
- Open the door fully and fit the side bricks to each side of the firebox. Location lugs are fitted to the base and rear wall of the firebox to retain the side bricks in position. Refer to Diagram 2
- Attach the handle to the door spindle by screwing it on clockwise
- Attach the air control knob by screwing it on clockwise.

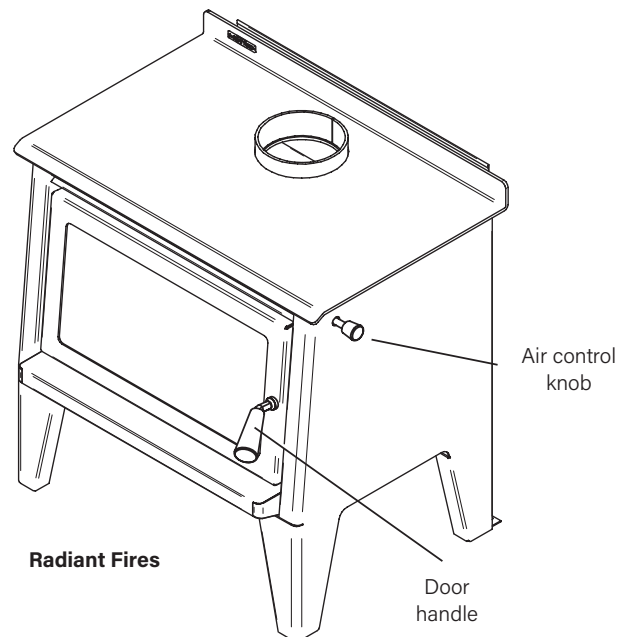

# ASSEMBLING YOUR METRO FIRE

## **⚠ CAUTION! Important Information**

- The pedestal heat shield **MUST** be fitted between the firebox and pedestal base for safety and compliance.

### Metro pedestal and base model fires

To eliminate freight damage, the pedestal base has been packaged inside the firebox. Flue shield bracket 5A has also been packaged inside the firebox for the following pedestal models: Tiny Ped, Wee Ped, Xtreme Ped.

To safely assemble your Metro, please proceed as follows:

- Lift off the top grill (convection models only) and place somewhere safe. Be careful not to chip the enamel coating or damage paint
- Open the door 45 degrees and lift the door off the hinge and place somewhere safe. Be careful not to damage the finish
- Remove the pedestal packed in a cardboard wrap
- Remove, rotate and re-fix the mount plate to the pedestal

**Note:** The pedestal mount plate is fixed to the back of the pedestal base with 4x screws. This mounting plate must be removed, rotated and re-fixed to the pedestal as detailed on page 4 in Diagrams 3 and 3A. The return fold must face back the opposite way to create the mount plate and fixing points for seismic restraint of the wood fire.

- Remove the pedestal heat shield

**Note:** For some models the pedestal heat shield may be taped to the rear heat shield. The Tiny Ped pedestal heat shield is pre-fitted.

- Remove the side bricks, door handle and the bolt bag
- Remove the 2 tek screws inside the base of the firebox that fix the wood fire to the pallet.

### It is recommended that 2 people work together with the next steps:

- Grab the underneath top of the firebox door opening with one hand, holding the flue spigot with the other, slowly lift the front of the wood fire all the way back and rest the wood fire on its rear heat shield on the floor. Remove the packaging pallet.
- Fit the pedestal heat shield over the 4 bolts as shown in Diagram 1, with the open edge facing the front of the Metro (up)
- Position the pedestal with its front facing over the 4 bolts and fit the washers and nuts supplied, check to ensure the pedestal is correctly aligned and securely tighten the nuts.
- Grab the flue spigot with one hand with the other hand underneath the top of the firebox door opening to lift and stand the fire up
- Fit the side bricks to each side of the fire box. Location lugs are fitted to the base and rear wall of the firebox to retain the side bricks in position. Refer to Diagram 2.
- Re-fit the door and top grill (convection models only)

### All Metro models

Check to ensure the top baffle is in its correct position in the top chamber of the firebox. It should be resting on four support lugs (two on each side of the firebox). The baffle must be hard back against the rear of the firebox with the promet extension (white brick) or return front steel edge of the baffle facing forward as illustrated in Diagram 2.

**Note:** Some models feature a two-piece top baffle.

Diagram 1

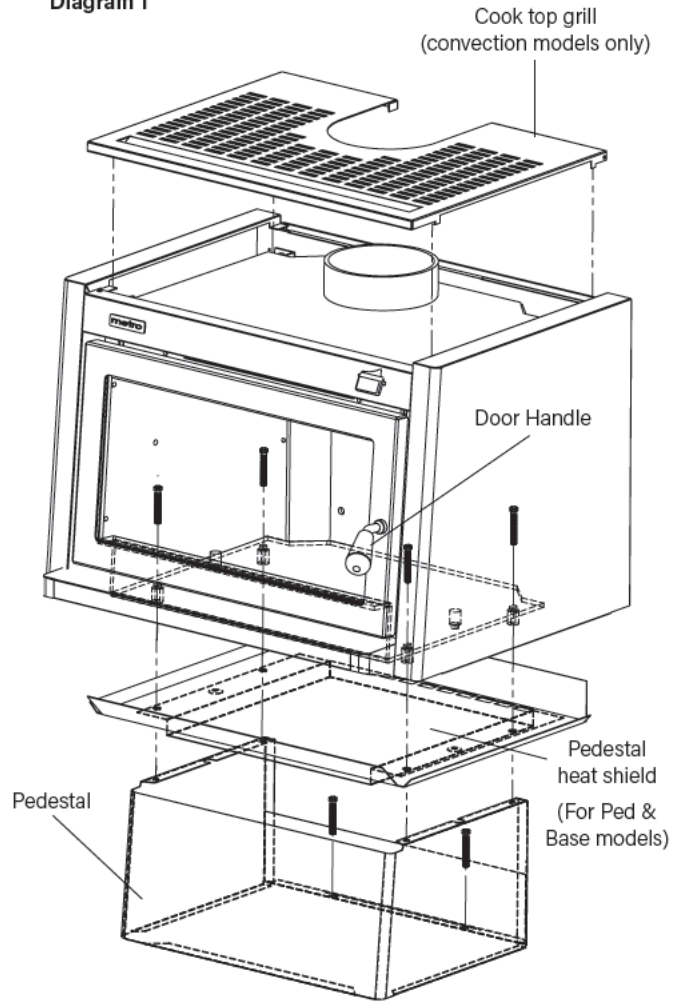
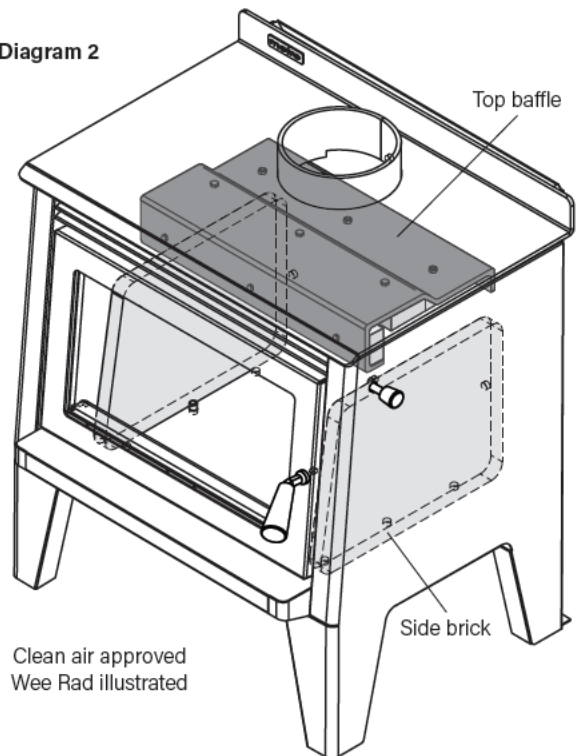

Diagram 2



## FLOOR PROTECTORS

Pioneer manufacture an extensive range of Pioneer 'Ash Floor Protectors' which comply with the minimum floor protector requirements of AS/NZS 2918 and can be installed with any freestanding Metro wood fire.

Metro freestanding wood fires do not require an insulated floor protector as they comply with the minimum floor protector requirements of AS/NZS 2918. These minimum floor protector requirements are;

- They must be of adequate size to give appropriate wall, rear and front clearances/projections as detailed in the Clearances and Specifications table on page 7
- The floor protector must extend 200mm horizontally to the rear and each side directly below the door opening, and 300mm forward of the door opening
- The upper surface of the floor protector must be made of non-combustible material.

A suitable floor protector for a Metro freestanding wood fire is therefore any non-combustible material which could include;

- Ceramic tiles with grouted joints fixed directly to a hard base over timber flooring
- A sheet of toughened glass, panel steel etc. laid directly onto a wooden or other combustible flooring material.

### Metro radiant fires

Lift the Metro fire onto the floor protector and using a suitable measuring device, ensure that the minimum wall clearances and front floor protector projections as detailed in the table on page 7 are met or exceeded.

Once the Metro's location on the floor protector is established and if the installation is within New Zealand, seismic restraint to comply with AS/NZS 2918, 3.8 is required.

**Note: The anchors must pass through the floor protector and securely anchor the Metro to the sub floor.**

### Metro pedestal and base model fires

Prior to lifting the Metro fire onto the floor protector, ensure you have removed, rotated and re-assembled the mount plate from the back of the pedestal base as detailed in Diagrams 3 & 3A opposite. This rear panel must be rotated with the return fold facing back the opposite way to create the mount plate and fixing points for seismic restraint of the wood fire.

Lift the Metro fire onto the floor protector and using a suitable measuring device, ensure that the minimum wall clearances and front floor protector projections as detailed in the table on page 7 are met or exceeded.

Once the location of the fire is established, you can then secure the Metro through the floor protector into the floor using the two seismic restraint holes in the rear edge of the mount plate.

**Note: The anchors must pass through the floor protector and securely anchor the Metro to the sub floor.**

### Preparing the mount plate

Diagram 3

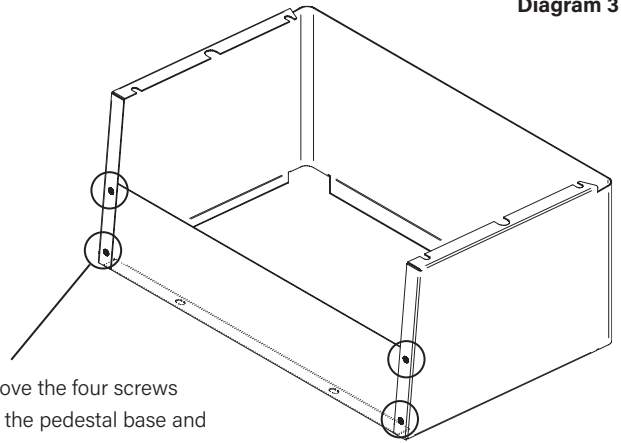

Remove the four screws from the pedestal base and rotate the mount plate so the return fold faces back the other way. Refix in place.

Diagram 3A

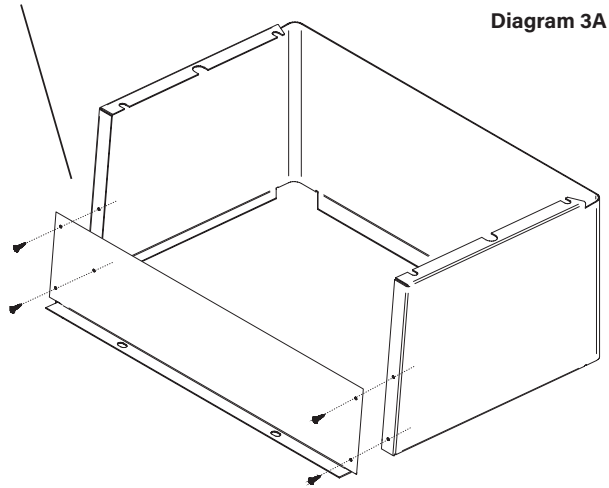

### Correct mount plate position

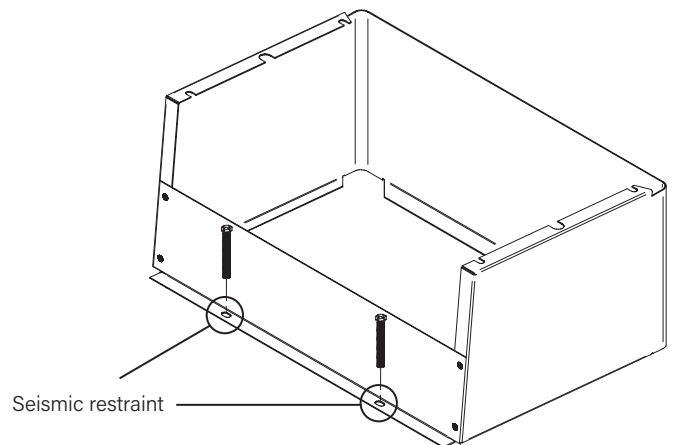

# FLUE INSTALLATION

It is recommended that all Metro freestanding wood fires be installed with the energy efficient ECO Flue System which comes complete with a detailed installation manual. This installation manual must be presented with your application to gain consent with your local council.

A copy of the ECO Flue System installation manual can be downloaded from [metrofires.co.nz](http://metrofires.co.nz), or a copy can be obtained from your Metro retailer. Any alternative flue system must comply with and be installed as detailed in AS/NZS 2918, and a copy of the installation manual must also be presented with your application to gain consent with local council.

All Metro fires require a 150mm diameter flue. Please note:

- Metro ECO flue systems must be installed to allow unrestricted air supply from either the ceiling cavity for an ECO Flue Kit, or above the roof line if the ECO Flue Kit and ECO Option Kits are both installed
- The ECO flue system must be installed into a 'vented' flat ceiling cavity, or have an ECO Option Kit added to the flue system to provide an external air supply
- ECO flue systems shall be installed in accordance with AS/NZS 2918 and the appropriate requirements of the relevant building codes
- Any modification to this flue system that has not been approved in writing by the testing authority is considered to be in breach of all approvals granted

- The flue systems 150mm diameter flue pipe must terminate a minimum of 4.6 metres above the top surface of the floor protector
- All joints in the flue pipe must be sealed with Pioneer fire cement (or similar) and riveted. The base of the flue pipe must also be sealed into the Metro fires flue outlet. This is critical for optimum operation.

All Metro fires have been tested with a Pioneer double flue shield. For the Metro fire to be installed with the minimal clearances as detailed on page 7, only the Pioneer double flue shield can be used. All other flue shields will invalidate the installation.

The Pioneer double flue shield is a universal design with two alternative lower mounting brackets. Bracket 5A is suitable for fires with an inner rear heat shield and is packaged inside the firebox of these models (Tiny Ped, Wee Ped, Xtreme Ped). Bracket 5B is packaged with the flue shield and is suitable for all other freestanding Metro fires detailed in this manual.

Detailed below are the more common installation methods for installing Metro ECO flue systems. To ensure a safe and efficient installation, this flue system must be installed as detailed below by either a registered installer, or someone competent in installing solid fuel appliances.

## Single storey installations

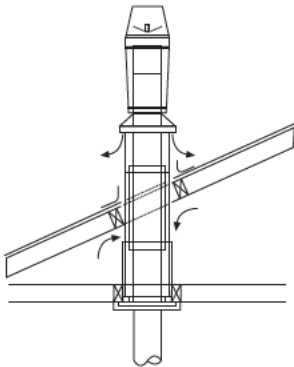

### Flat cavity ceiling

Requires the ECO flue kit as air is drawn into the flue system directly from the homes vented ceiling cavity.

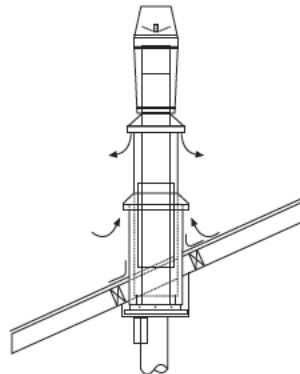

### Sloping ceiling

Requires the ECO flue kit and ECO option kit for air to be drawn into the flue system from outside the home.

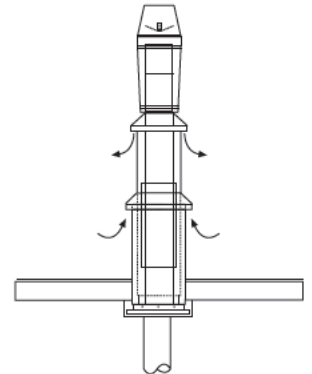

### Flat ceiling/roof

Requires the ECO flue kit and ECO option kit as per sloping ceiling unless a vented ceiling cavity exists.

## Two storey installations

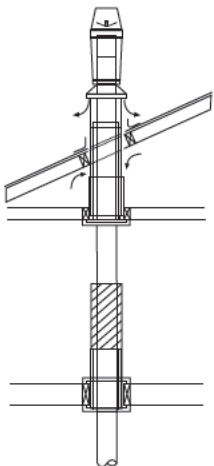

### 2nd floor - Exposed flue pipe

Requires the ECO Flue Kit with additional lengths of 150mm flue pipe.

Additional components are also required for this type of installation in accordance with AS/NZS 2918\*

- A floor penetration kit
- 1x 1200mm long mesh/screen

\*Not supplied by Metro Fires

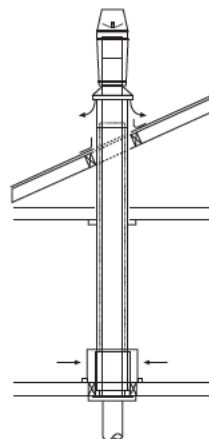

### 2nd floor - Enclosed flue pipe

Requires the ECO Flue Kit with additional lengths of 150mm flue pipe.

Additional components are also required for this type of installation in accordance with AS/NZS 2918\*

- 200/250mm inner/outer combination liners
- 2nd floor vent cover and additional ceiling plate with a 250mm diameter hole

\*Not supplied by Metro Fires

## WETBACK INSTALLATION

### **WARNING! Important Information**

- **DO NOT** connect to an unvented hot water system
- Install in accordance with AS 3500.4.1 or NZS 4603 and the appropriate requirements of the relevant building code(s).

### **CAUTION! Important Information**

- Wetbacks must be connected with water before operating the fire and water must always be available to the wetback while the fire is in operation
- Wetback systems are not suitable for use in locations where the water supply has lime content. Lime build up inside the coil will eventually block the coil causing the wetback to fail
- Rainwater collection tanks installed lower than the wetback that use a pump to supply the home, can cause problems if the pump is not operational. In these situations either the type of wetback or a roof header tank should be considered

Water heating is another key feature of your Metro wood fire. Almost all Metro models can be fitted with a wetback, which are designed to give maximum output with minimal effect on the operation of the fire.

Only the Pioneer cast jacket wetback system should be fitted to your Metro fire. Any alternative wetback system will void the Metro's emission approvals and may seriously affect the performance of the appliance and void its warranty.

Wetbacks can enable substantial power savings dependent on the climate in the area in which you live. If you live in a cold climate you are likely to use your Metro for many months of the year, in which case a wetback will reduce or even eliminate your water heating costs over these months. If however you live in a warmer climate and use your Metro for only a few hours a day, electricity savings will likely be less.

- Distance from your Metro fire to the storage cylinder will affect the amount of hot water produced
- Your climate and the manner in which you will 'fire' your Metro will determine the amount of hot water produced.

#### Wetback connections

Wetback connection heights for all models are illustrated and detailed opposite on page 7. Wetback centres are measured to the left of the flue centre when facing the Metro fire/wall as follows:

- |  |       |
|--|-------|
| • Tiny Ped and Tiny Rad models         | 92mm  |
| • Tiny Rad Woody model                 | 184mm |
| • Wee Series clean air approved models | 226mm |
| • All other wetback capable models     | 140mm |

All wetbacks are fitted to the inside rear wall of the firebox, with the exception of the Tiny Rad Woody and the Wee Series clean air models. Side wetback position for these models is to the outside left hand firebox wall. Please see the specific installation instructions in the 'Side Wetback' box for installation of a wetback into these appliances.

**Note:** It is recommended the return pipe has a minimum rise of 1 in 12. Performance will reduce as the distance to the cylinder increases.

#### To fit the wetback proceed as follows:

1. Remove the rear panel of the Metro by removing the four pozi drive screws. Remove the two pre-punched knockouts from this panel.
2. Two further knockouts will be visible on the inner rear heatshield, remove these also. Once these are removed 6mm nuts will be visible through the knockout holes.
3. Open the Metro's door and locate two bolts securing the pressed washers which are visible on the left hand side of the firebox for both inlet and outlet connection points.
4. A further three bolt heads will also be visible on the inside rear wall of the firebox. These are threaded into the 6mm thick firebox. Remove all three bolts.
5. Using the tube of sealant supplied with the wetback, apply a liberal bead of sealant around both connection holes on the inside of the firebox. On the rear of the wetback casting apply the remaining contents of the tube equally around both connection pipes and also the outer circumference of the wetback which will face and press against the inside rear wall of the firebox. This will completely seal the wetback to the inside rear wall of the fire for correct installation.

**Note:** Ensure there is no gap between pipe and rear wall access holes. This cement must fully cure before appliance use.

6. Fit the wetback into the firebox and carefully pass the connection pipes through the holes in the rear wall of the firebox. Securely attach the wetback using the three bolts previously removed from the rear face of the firebox, fitting them through the slots provided in the wetback's jacket.
7. The wetback is now ready for connection to the storage cylinder by a registered plumber.

#### Wetback

#### Suitable for models

##### 2kW Wetback



- Tiny Ped
- Tiny Rad

##### Side Wetback



- Tiny Rad Woody
- Wee Rad Leg and Wee Rad Base
- Wee Rad Woody
- Wee Ped

##### 3kW Wetback



- Xtreme Rad Leg and Xtreme Rad Base
- Xtreme Rad Woody
- Xtreme Ped
- Mega Rad
- All LTD rural models

##### 4kW Wetback



- All LTD rural models

**Note:** The Wee Curve DV model cannot be fitted with a wetback.

# CLEARANCES AND SPECIFICATIONS

## Minimum clearances

All Metro freestanding fires comply with AS/NZS 2918. Minimum clearances detailed below are in millimetres, with a Pioneer double flue shield fitted to the appliance. Measurements are taken from the following reference points as illustrated:

- The nearest combustable wall or surface (A, B, D, E, G, H)
- The Metro's flue centre (A, B, C, D)
- The Metro's cabinet/heatshield outermost point (E, F, G, H)
- The edge of the ash floor protectors non-combustible surface (C, F, I, J, K, L, M)

AS/NZS 2918 allows for a reduction in minimum clearances as detailed in Section 3, Tables 3.1 and 3.2 of the Standard.

Some Metro models have undergone additional testing for reduced installation clearances. Please see the footnotes below the clearances table for these applicable models.

## Wetback connections (taken facing the Metro/wall)

Wetback connection heights (N and O) are detailed in millimetres. Wetback centres are measured to the left of the flue centre when facing the Metro fire/wall as follows:

- Tiny Ped and Tiny Rad models 92mm
- Tiny Rad Woody model 184mm
- Wee Series clean air approved models 226mm
- All other wetback capable models 140mm

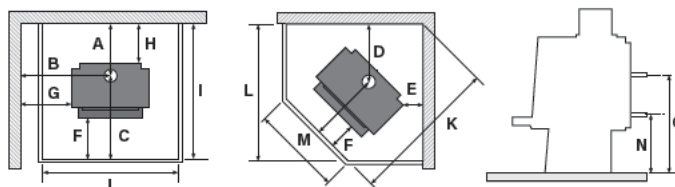

### MINIMUM INSTALLATION CLEARANCES (mm)

Clean air models	MINIMUM INSTALLATION CLEARANCES (mm)												WETBACK DIMENSIONS					
	A	B	C	D	E	F	G	H	I	J	K	L	M	N	O	WIDTH	DEPTH	HEIGHT
Tiny Ped	211	433	580	290	25	235	185	60	791	650	990	780	250	280	470	496	492	659
Tiny Rad	230	553	585	419	150	232	300	75	815	650	1180	910	250	280	470	505	508	667
Tiny Rad Woody	251	568	580	382	110	232	310	100	831	650	1120	870	250	365	555	515	498	758
Wee Rad - Leg <sup>1</sup>	251	568	580	456	150	232	260	100	831	825	1225	1016	425	295	485	615	501	688
Wee Rad - Base	271	678	580	486	180	232	370	120	851	825	1270	1048	425	295	485	615	501	691
Wee Rad - Woody	271	708	580	506	200	232	400	120	851	825	1295	1066	425	365	555	615	501	758
Wee Curve DV	253	555	600	405	100	214	250	100	853	825	1171	980	426	n/a	n/a	607	539	667
Wee Ped <sup>2</sup>	263	651	580	473	170	230	350	110	843	825	1250	1034	425	295	485	602	503	665
Xtreme Ped	251	624	630	442	110	226	280	100	881	907	1260	1070	507	312	502	688	554	707
Xtreme Rad - Leg	251	650	630	458	100	227	280	100	881	907	1280	1084	507	312	502	740	554	743
Xtreme Rad - Base	251	650	630	458	100	227	280	100	881	907	1280	1084	507	312	502	740	554	743
Xtreme Rad - Woody	251	680	630	478	120	227	310	100	881	907	1306	1103	507	382	572	740	554	813
Mega Rad	285	720	728	497	100	224	300	130	1013	1006	1435	1229	606	300	490	840	659	744

LTD rural models	MINIMUM INSTALLATION CLEARANCES (mm)												WETBACK DIMENSIONS					
	A	B	C	D	E	F	G	H	I	J	K	L	M	N	O	WIDTH	DEPTH	HEIGHT
LTD Wee Rad - Leg	251	548	580	426	120	232	240	100	831	825	1185	989	425	295	485	615	501	688
LTD Wee Rad - Base	251	658	580	486	180	232	350	100	831	825	1270	1048	425	300	490	615	501	691
LTD Wee Rad - Woody	271	708	580	506	200	232	400	120	851	825	1295	1066	425	365	555	615	501	758
LTD Xtreme Rad - Leg	251	650	630	458	100	227	280	100	881	907	1280	1084	507	350	540	740	554	743
LTD Xtreme Rad - Base	251	650	630	458	100	227	280	100	881	907	1280	1084	507	350	540	740	554	743
LTD Xtreme Rad - Woody	251	680	630	478	120	227	310	100	881	907	1306	1103	507	420	610	740	554	813
LTD Mega Rad	285	720	728	497	100	224	300	130	1013	1006	1435	1229	606	300	490	840	659	744

The Wee Rad - Leg model installed with a Pioneer double flue shield with the Pioneer corner wing shields fitted allows for reduced clearances as follows:

<sup>1</sup> Wee Rad - Leg corner clearance (E) can be reduced to 120mm. This in turn also reduces clearances (D) to 426mm, (K) to 1185mm and (L) to 987mm. When fitting the corner wing shields, the Wee Rad - Leg itself must be installed to a corner clearance (E) of 120mm. The corner wing shields are then fitted which gives a wall to shield corner clearance of 100mm.

The following models installed with a Pioneer double flue shield with the side extensions fitted allows for reduced clearances as follows:

<sup>2</sup> Wee Ped corner clearance (E) can be reduced to 115mm. This in turn also reduces clearances (D) to 418mm, (K) to 1170mm and (L) to 978mm.

Specifications were correct at the time of printing, but may alter and those detailed within should be used only as a guide. If in doubt, please consult your Metro specialist or metrofires.co.nz.

## **WARNING! Important Information**

**WE HIGHLY RECOMMEND YOU READ THIS ENTIRE MANUAL AS INCORRECT OPERATION, MISUSE AND/OR LACK OF MAINTENANCE WILL VOID THE WARRANTY**

- **Any modification of the appliance that has not been approved in writing by the testing authority is considered as breaching AS/NZS 4013 and will void the warranty**
- **DO NOT use flammable liquids or aerosols in the vicinity of this appliance when it is operating**
- **DO NOT operate your Metro with the top grill removed**
- **DO NOT dry clothes on or near this appliance**
- **DO NOT use flammable liquids or aerosols to start or rekindle the fire OR store fuel within the specified clearances**
- **DO NOT operate your Metro with the door ajar, except on initial start up**
- **DO NOT empty ash into a combustible container**
- **Open the air control fully before opening the Metro's door**

## **CAUTION! Important Information**

**THIS APPLIANCE MUST BE MAINTAINED AND OPERATED AT ALL TIMES IN ACCORDANCE WITH THIS MANUAL**

- **DO NOT operate this appliance with cracked door glass, worn, faulty or missing door seals**
- **DO NOT burn driftwood, treated or unseasoned fuel (wet). The use of most types of preservative treated wood as fuel can be hazardous and will damage your appliance**
- **Burning unseasoned fuel (wet) or incorrect operation on extended low burn cycles will cause excessive creosote to form. Creosote is very corrosive and excessive buildups will result in the flue pipe, flue spigot and upper burn chamber failing. Failure of the firebox and/or flue system due to creosote is not covered under warranty. The formation of such is not an appliance issue, it is a fuel and operational issue**
- **All replacement parts must be authorised Metro parts only**

## **IMPORTANT OPERATION INFORMATION**

Your Metro fire is designed to give you many years of warmth and service, subject to the following key factors. These key factors, if not adhered to are the major causes of unsafe installation, poor performance, flue blockages and potential product issues.

1. Your Metro fire must be installed correctly. We recommended you have your new fire installed by a NZHHA registered installer or a competent and suitably qualified installer.
2. In New Zealand a building consent is required from your local building authority. The homeowner is responsible for obtaining this consent.
3. It is preferable that Metro fires should be installed with a Metro ECO Flue System for improved heat retention.
4. Properly seasoned (dry) wood is necessary for your fire to operate efficiently. Wood with a high moisture content will result in flue pipe blockages, reduce heat output and create other issues. The only fuel to be used in this fire shall be wood that meets the following criteria.
  - Less than 25% moisture content
  - Has not been treated with preservatives or impregnated with chemicals or glue,
  - Is not chipboard, particle board, or laminated board,
  - Is not painted, stained or oiled
  - Is not driftwood or other salt impregnated wood
  - Coal must not be used as a fuel

**Note: Once split, Softwood usually takes a minimum of 12 months to season - Hardwoods can take up to 24 months to season - Wood must be stored in a location that enables air circulation. Unseasoned wood stored in a closed woodshed without air circulation will still remain unseasoned 12 months later.**

5. Burning unseasoned (wet) fuel or incorrect operation on extended low burn cycles will cause excessive creosote to form. Creosote is very corrosive and excessive buildups will result in failure of the flue pipe, flue spigot and upper burn chamber. Failure of the appliance and/or flue system due to creosote damage is not covered under warranty. The formation of such is not an appliance issue, it is a fuel and operational issue.

### **Regular maintenance**

- **DO NOT** operate the fire with worn, faulty or missing door and glass seals. Door seals harden over time and become worn (3-4 years). This allows air to leak into the firebox, causing the appliance to 'over fire'
- **DO NOT** operate the fire with worn, faulty or missing bricks, baffle plate, promet (white brick attached to the baffle plate)
- **DO NOT** operate the fire with cracked or broken door glass.

**Note: The above 3 points require regular inspection/maintenance (every time the ash bed is cleaned out, generally 3-5 times a season) and if not maintained will void the firebox warranty. A glowing firebox or lower fluepipe is just one sign you are over firing your appliance. Please ensure you keep your proof of purchase/receipt on any parts you purchase.**

Your Metro is covered by a full unconditional 12 month warranty on replacement parts, and a 10 year firebox warranty.

### **Heat output**

Metro Fires peak outputs (kW ratings) are based on the NZHHA Maximum Output test method which is undertaken by independent International Accredited New Zealand (IANZ) testing facilities. IANZ accreditation provides assurance that the independent testing facility operates effective quality processes, providing a professional service through expertise and technical competence that is recognised as world-class.

A specific loading method is used with specific fuel to obtain the results, which includes using dry 100mm x 50mm pine and the appliance being loaded and operated on the high setting for an extended period of time. During this time the appliance is periodically refuelled until the appliance reaches it's peak output.

**Note: It is not recommended that the appliance be continually operated at it's peak output as this could increase the chance of damage to the appliance firebox and associated parts.**

## GETTING TO KNOW YOUR METRO FIRE

There is a single air control making your fire easy to adjust. The air control moves from left to right, which is 'low to high'. Slide this control knob gently from right to left until you reach a stop. This is a pre-set 'low' position. Your Metro must not be operated at a lower burn rate than this setting.

Raising the door handle anti-clockwise until the latch releases will open the door. You will note that if you let the door go before it is at 90° to the appliance, it will fall closed. This is a safety feature that ensures the door cannot fall open if it is not latched securely. For the door to remain open, you must open it fully.

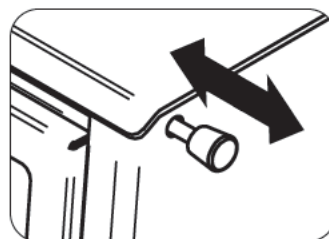

Radiant fires air control adjustment

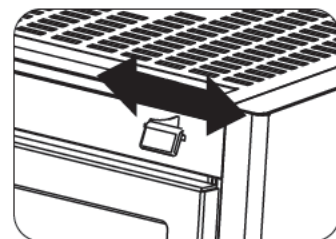

All other fires air control adjustment

## OPERATING YOUR METRO FIRE

If your Metro has only been installed within the past few days, the fire cement seal at the base of the flue will not be fully cured. To ensure the cement sets without blistering it is recommended you burn 2-3 sheets of loosely crumpled newspaper at a time, approximately once every hour over a 6-8 hour period.

During the very first fire your Metro will give off an odour and fumes as the firebox paint cures. Do not be alarmed; open all windows and externally opening doors in that room and close any internally opening doors. The fresh paint finish on your wood fire needs to be cured to preserve its quality and the curing process will last for approximately one hour and is likely to happen this one time.

**IMPORTANT:** Burning a small fire at a medium burn rate for the first few hours of operation will achieve the optimal curing process. Too hot or too cold could present curing issues.

### Start up

Place 3 or 4 smaller pieces of wood across the base of the fire orientated in a front to back direction with air gaps between each piece.

Place a couple of firelighters on top of this base fuel near the front. It's ideal if the firelighters are approximately at the bottom of the door opening. Place some layers of kindling over the base fuel and firelighters. Some smaller pieces of fuel similar to that placed in the base should be placed above the kindling in a front to back orientation with air gaps between. The fire box can be loaded to ¾ full of fuel with a clear space below the baffle.

With the air control fully open (extended to the far right) light the firelighters and leave the door ajar for two minutes, but only if necessary. It's best to shut the door as soon as possible to allow the fire to self-generate. Leave the fire to fully light and burn down to a healthy ember base over the next 30 to 45 minutes before loading additional fuel.

### Normal operation

Once the fire is well established, regulate the air control to achieve the desired burn rate and heat output. As you move the air control to the right, burn rate, firebox temperature and heat output will increase, if you move the control to the left they will decrease. Please note:

- Always open the air control fully prior to opening the door, then open the door slowly. Every time you refuel, leave the air control on 'high' for a minimum of 20-25 minutes to ensure proper combustion
- When loading wood, place pieces end-on, 'front to back' in preference to laying across the width of the firebox. Air spaces should be left between the pieces of wood to enable oxygen to get to as much of the surface of the fuel as possible

- A small hot fire loaded frequently is more efficient than a large fire burning on a low setting
- Never use the door to force wood into the firebox, as this is likely to break the glass.

### Extended burning (rural models only)

It is most important if your Metro is to be refuelled and turned down for an extended period, such as an overnight burn that you operate it correctly.

- The wood used as fuel for extended burning **MUST BE FULLY SEASONED (DRY)**. Once the fuel is loaded, the appliance must be operated on high for a period of at least 20 minutes to drive out residual moisture from the fuel (dry wood is usually 20% water content) and ensure surface area combustion.
- **DO NOT** turn the air control down lower than you need to. If you want the Metro to burn overnight, endeavour to obtain an 8 hour burn time, not 12 hours. It will take a few burns to find the correct location of your Metro's air control setting to achieve the length of burn cycle you desire as this setting is affected by several variables including fuel density, flue length and outside wind velocity.
- A smouldering fire over an extended period is likely to deposit corrosive elements into your system which could be detrimental to your Metro.

### CAUTION! Important Information

If not operated correctly on extended burn cycles, your Metro is likely to incur flue pipe blockages, corrosion of the upper baffle, lower flue pipe and firebox flue spigot. As these are not covered under warranty if they fail through improper use, it is important you operate your Metro correctly.

### Cooking

All Metro's are designed to enable cooking of soups, stews and casseroles etc, and your Metro will easily boil a flat bottom stainless steel kettle. Metro radiant models have a dedicated cooking top enabling large pots to be placed on the cook top, while all other models have a lift-off grill.

**Note:** Metro's supplied with a lift-off top grill have this feature to enable the grill to be removed for cleaning if you have a spill. The lift-off top grill must remain in place when cooking, because if removed the wall temperatures next to the appliance may become excessive and the top of the firebox is generally too hot to cook on directly.

## CLEANING AND MAINTENANCE

### **WARNING! Important Information**

**WE HIGHLY RECOMMEND YOU READ THIS ENTIRE SECTION AS LACK OF MAINTENANCE AND SERVICING PARTS AS REQUIRED MAY VOID THE WARRANTY**

- **This appliance must be regularly maintained and operated at all times in accordance with this instruction manual. All replacement parts must be authorised Metro parts only.**

### **CAUTION! Important Information**

- **DO NOT operate this appliance with cracked door glass.**
- **DO NOT operate the fire with over worn, faulty or missing door seals. Door seals will harden over time and allow excess air to leak into the firebox causing the appliance to 'over fire'!**
- **DO NOT empty or store ashes in a combustible container.**
- **DO NOT use Stove Black, Cast Iron Stove Polish or similar based products to refurbish your paint finished fire. Pioneer Metallic Black high temperature paint is the ONLY product suitable for revitalising the paint finish on your Metro fire.**

Your Metro fire will give you many years of efficient service with minimal maintenance if operated correctly using dry well seasoned fuel. Your Metro fire must be regularly maintained and any replacement parts must be genuine authorised Metro fires parts only. We recommend using a suitably qualified service agent.

#### **Metro paint finish fires**

Metro paint finish wood fires are coated with Pioneer Metallic Black high temperature paint. Over time paint finish fires will require periodic repainting to keep them looking their best. A coastal installation will likely require more regular maintenance over an inland environment due to the presence of salt laden air. Pioneer Metallic Black high temperature paint is the ONLY product suitable for revitalising the paint finish on your Metro fire.

**DO NOT use Stove Black, Cast Iron Stove Polish or similar based products to refurbish your paint finished fire.**

- The high temperature paint coating is porous to allow for expansion of the product materials and will degrade over time due to the temperatures experience during normal operation
- **DO NOT** wipe the painted surfaces with anything other than a dry soft cloth. Any ash on the surface when wiping will act as an abrasive to the surface finish
- **DO NOT** use any abrasive, solvent based or general household cleaners on your appliance as they will damage the surface coating
- Hot coals left on the ashlip, even for a short time, will burn off the painted surface exposing the parent material to oxidation
- Take note that high salt laden air environments (coastal installations) can impact on the appliances surface degradation

All Metro fires can be easily cleaned with a dry soft cloth when the appliance is not in operation.

#### **Door glass**

Providing your fuel is properly seasoned, under normal operating conditions the air-wash design of the Metro's firebox will keep the door glass clear.

If the glass requires cleaning you may use either a razor blade scraper or crumpled wetted newspaper dipped in wood ash rubbed over the glass.

- **DO NOT** use any general household cleaners or solvents to clean the glass on your Metro fire
- If your door glass breaks it must be replaced with 5mm thick ceramic glass which is available from your local Metro retailer
- Never use the door to force wood into the firebox, as this is likely to break the glass.

#### **Door seals**

The door and glass seals are something to be mindful of to achieve the optimum performance and heat output from your Metro fire.

A loose fitting door or glass panel are clear signs that the appliance seals need to be addressed. You may also notice that you're burning through more firewood than usual due to the excess air entering the firebox.

Over time (usually around 3-4 years) your Metro door rope and glass seals will gradually harden. When this happens, these worn seals will start to allow air to leak into the firebox, causing the appliance to 'over fire' and use more firewood during operation. Your Metro retailer stocks replacement door rope and glass tape for renewing these seals.

The door of your Metro is easily removed to replace both door and glass seals. Hold the door in both hands and lift the hinge end of the door up and over the top hinge pin, then carefully lower the door from the bottom hinge pin taking care not to damage the ashlip and/or appliance coating.

#### **Fire bricks**

Hair-line cracks are not uncommon and are a result of the intense heat within the firebox, coupled with mechanical damage caused by accidental impact when loading fuel. If the fire bricks become cracked to the extent that they start to break up and fall into the fire, they must be replaced.

#### **Door adjustment**

Provision is available on both sides of the door for adjustment.

To adjust the hinge end of the door, open the door fully, loosen the top hinge nut and slightly lift the latch end of the door. You will see the hinge assembly move back 1-2mm which will usually be sufficient. Retighten, then repeat by loosening the lower hinge nut, this time applying a slight downwards pressure onto the door to move the lower hinge assembly back a similar distance, then retighten.

The door latch is also adjustable as the latch pin on the right side of the firebox is fitted through a slot. This enables the latch pin to be loosened, moved forward/back and re-tightened to ensure a good tight door seal.

## CLEANING AND MAINTENANCE

---

### Ash removal

Over a period of time ash will build up in the base of the Metro's firebox and require removal. The time this build-up takes depends on the density and cleanliness of your fuel.

DO NOT operate your fire continuously with a high ash or ember bed as you can damage the firebox rear wall components or increase the likelihood of necessary maintenance.

To remove the excess ash your Metro should not be operating.

- Open the door, and using a hearth shovel or similar, empty the excess ash directly into a steel or non-combustible container. If the ash is not disposed of immediately, be careful where you store it, as the ash can retain heat for many days and become a fire hazard.
- You must leave a bed of ash in the base of the firebox approximately 10mm deep. This insulates the firebox base and improves combustion.

### Top baffle

This is a 'sacrificial' wear part of the firebox and should be checked monthly. Usually only the promet (white brick) front/underneath section needs to be replaced when it starts to disintegrate and fall into the firebox.

To remove and replace your Metro's top baffle, proceed as follows: -

- Fully open the Metro's door and remove the side firebricks carefully. This will give you maximum firebox width to easily remove the baffle
- Reach inside with the palms of your hand face up and extended and lift the top baffle up vertically towards the ceiling of the firebox. You can then pull the baffle assembly forward towards the front of the firebox. This will allow you to then lower the rear of the baffle past the lug supports and lift it out through the door opening. Place it onto a sheet of newspaper or similar to protect the floor protector/coverings
- To refit the top baffle. Proceed in the reverse order and note, the baffle must be fitted so its rear is touching the back wall of the firebox.

**Note: Cracks in the promet are not uncommon and have no adverse effect on the operation of your Metro. These cracks are the result of intense heat coupled with expansion and contraction. Impact damage when loading wood and burning wood which is not properly seasoned, i.e. 25% moisture content or more, will cause the promet to disintegrate and require replacement.**

### Flue systems

Should be checked annually, particularly the bottom end of the lower flue section at its rear lock formed joint. If deterioration is noticed contact your Metro retailer or installer.

The flue pipe should also be swept a minimum of once a year, or as required during the winter season. If smoke enters the room when you open the Metro's door this usually indicates the flue pipe is becoming restricted and needs cleaning. The frequency of flue pipe cleans depends on many factors, with the main variables being:

- The seasoning of the wood. If not properly seasoned you will require frequent flue pipe cleans.
- The density of the wood. Softwoods generally result in more deposits building up in the flue pipe.

To clean the flue pipe of your Metro, proceed as follows:-

- Open the Metro's door fully, reach inside with the palm of your hand face-up and extended, lift the top baffle approximately 20mm, then lift it forward out through the door opening, placing it on a sheet of newspaper you have placed on the front of the floor protector. To prevent jamming, removal and replacement of the top baffle is best performed using both hands.

**Note: Some appliances have a two piece top baffle.**

- Close the door and slide the air control to the left.
- Once on the roof, remove the cowl from the top of flue system and sweep the flue pipe using a 150mm-diameter flue pipe brush as detailed in the instructions provided with the fluebrush.
- Once the flue pipe is clear, clean and refit the cowl. Remove the excess soot which has fallen into the firebox, leaving a layer of ash 10mm deep on the base of the firebox, then refit the top baffle.

**Note: The baffle must be fitted so its rear is touching the back of the firebox. If uncertain refer to page 3 in the installation section at the front of this manual, which shows illustrations of the baffle location.**

### Wetback blanking plates

Metro models that can be fitted with an internal wetback will feature two wetback blanking plates in the rear wall of the firebox. These plates 'seal' the wetback connection holes and are only removed if you choose to fit a wetback to your fire.

#### NO WETBACK FITTED

The wetback blanking plates should be checked annually, as any corrosion/erosion or deterioration can allow air to leak into the firebox at these points causing the appliance to 'over fire' and stress firebox integrity.

If deterioration is noticed during regular servicing and maintenance, please contact your Metro retailer or installer to have these blanking plates and sealing compound replaced. Failure to act on this may impact on warranty.

#### WETBACK FITTED

Wetback connection holes are sealed by your installer during wetback installation. The connection holes should be checked annually to ensure the seal remains intact, as any deterioration can allow air to leak into the firebox causing the appliance to 'over fire' and stress firebox integrity.

If deterioration is noticed during regular servicing and maintenance, please contact your Metro retailer or service agent. Failure to act on this may impact on warranty.

## TROUBLESHOOTING

---

If your Metro is installed correctly, your fuel is dry and you operate your fire correctly, you will find it to be a pleasure to use. Metro's many years of experience within the wood heating industry has shown that dissatisfaction is mainly due to:

- unseasoned fuel
- faulty installation
- operational error
- or a combination of the above 3 points.

### Correct operation

Modern day wood fires need to be operated hard and fast, more so than low and lazy to ensure the firebox and flue pipe runs hot and efficiently. If the fire and flue pipe is up to temperature it will perform extremely well, the smoke will draw up the flue pipe with ease, and the fire will produce good amounts of heat.

If the fire is operated on low a lot of the time, the door glass will run black, the flue pipe will tend to block up more frequently and the fire will end up smoking into the room when reloading. It's better to have a small fire running hard and fast, rather than a big fire running low and lazy.

The following may be of assistance if you are experiencing any problems with the operation of your Metro Fire.

### Smoke enters the room when the Metro's door is ajar (possible reasons and solutions)

#### Check flue pipe joins

If the flue pipe joins are not sealed correctly, the flue pipe will not draw as well as it should. The flue pipe join connecting into the flue spigot on top of the Metro is most critical. If this is not sealed correctly, smoke will enter the room when the door is ajar. To check this join is sealed correctly, run a match or lighter flame around the join. If the flame is sucked into the spigot then it is not sealed correctly. This check needs to be done when the fire is not going. Ensure you check the rear of the flue pipe/spigot join, as due to the seam in the flue pipe, this is the most common area for not being sealed correctly.

#### Ensure the fuel you are using is correctly seasoned

If you are burning unseasoned fuel (wet), the fire will cause nothing but problems. The Metro won't deliver much heat, it will be lazy, smoke will enter the room when the door is ajar, and the door glass will run black. Unseasoned fuel is the main contributor to excessive creosote deposits which can be corrosive to your appliance and flue system.

#### Flue pipe length is too short

Add more flue pipe as the longer the flue system, the better the draw of the flue pipe. Please note, if you did not purchase the Metro ECO flue system, you will not have the ECO cowl which increases draw. We highly recommend the Metro ECO cowl is fitted as this will increase the draw. If you already have an ECO cowl and smoke is still entering the room, please add another 600mm length of flue pipe.

#### Downdraft/Turbulence blockage

If you have checked all of the previous factors and the fire is still smoking into the room, it's possible there may be a down draft issue. Down draft is environmental and can be caused by many variables, and it is purely trial and error to ascertain the cause.

Air turbulence and/or negative air pressure influences around the flue termination can be caused by too close or overhanging trees or natural/artificial ridges etc. Address these where possible or look to extend the flue above the roofline.

Other options may be:

- 'H' Cowl, designed purely for downdraft issues, but if you have an ECO cowl fitted as standard, you will also need to add another 600mm of flue pipe to compensate as the H cowl is shorter in length
- A directional cowl, designed to move with the wind direction. A simple solution for reducing down draughting and atmospheric issues in troubled areas.

### Air control setting

Ensure the air control setting is on high before opening the door to reload, as this increases the draw up the flue pipe. Open the door slowly.

If your Metro did not smoke, but its starting too and is getting worse:

The flue pipe is in need of a clean. It is recommended that the flue pipe be cleaned every season, however if you are burning the fire on low a lot, or are burning unseasoned fuel, flue pipe cleans will be required more frequently.

### Other issues you may experience

#### I can smell smoke in the room after a low burn cycle

The smell is creosote that will be seeping through the flue pipe join or out of the flue spigot onto an external surface, thus creating the smell in your room. The cause will be either unseasoned fuel, fuel mass too large, incorrect operation on low burn cycles or a combination of all three.

Creosote is very corrosive and excessive buildups will result in the flue pipe and potentially the flue spigot and upper burn chamber failing. The formation of excessive creosote is not an appliance issue, it is a fuel and operational issue. Failure of flue pipe or firebox due to creosote build up is not covered under warranty as excessive creosote build up is only possible from either unseasoned fuel or incorrect operation.

#### The Metro is noisy as it heats up and cools down

There will always be some expansion and contraction noise as a wood fire heats and cools. This can usually be reduced by loosening the fixings at the rear of the appliance. To remedy, locate the 25mm deep cavity at the rear of your Metro between the 'rear panel' and the 'inner rear heat shield'. Using a 10mm ring or open ended spanner, loosen any visible nuts/bolt heads so they are finger tight only.

On all Metro freestanding fires the air channel that allows the combustion air to enter the firebox is fitted to the top underneath of the door opening. It is fitted with two M6 bolts. Slightly loosen both of these bolts.

#### The Metro won't turn down as much as it did

The door itself may need readjusting, the hinge and latch is slotted and allows for movement. Loosening the hinge and moving it back a few mm will make the door seal tighter and stop air leaking into the fire. The door and glass seals may be in need of replacing, which is generally required every 3-4 years.

Familiarise yourself with the instructions on page 10 before proceeding with this maintenance.

# WARRANTY

## CAUTION! Important Information

**Your Metro fire must be regularly maintained and we recommend it is also serviced annually. Proof of servicing may be required. If your fire is not regularly maintained and serviced, the life span will be reduced. If your fire has been neglected by not being regularly maintained and serviced, a warranty claim may be declined.**

Metro wood fires are manufactured using the highest quality of materials, workmanship and the latest manufacturing techniques, which is why we offer a full 10 year firebox warranty and a 1 year parts warranty for your peace of mind.

### **Metro warranty (NZ Consumer laws apply to this warranty)**

Pioneer Manufacturing Limited (Pioneer) warrants the steel firebox against defective materials and workmanship which would render it unfit for normal domestic use, from the date of purchase by the original consumer, for a period of 10 years.

Components including panel coating, door retainers, door seals, glass, trim, baffle and bricks are warranted for a period of 1 year from the date of original purchase for normal domestic use against defective materials and workmanship.

All associated accessories including, but not limited to, fans, flue systems, flue shields, wetbacks, tool sets, ash pots etc, are covered by a 1 year warranty against defective materials and workmanship.

It is recommended, but not a condition of this warranty, that a full service/inspection of the Metro fire be carried out at the end of each winter season.

### **Warranty conditions**

- The Metro fire must be installed, operated and maintained strictly in accordance with the relevant building codes and this installation and operation manual
- The Metro fire must be installed and used in a domestic application
- The Metro fire requires regular inspection and maintenance every time the ash bed is cleaned out (generally 3-5 times a season). If the Metro fire has not been maintained correctly you will void the warranty. Please ensure you keep the proof of purchase/receipt for any parts purchased and servicing work completed.

- This warranty covers appliance like for like replacement or repair at the manufacturer's discretion but excludes freight, travel, installation, labour and/or any other associated costs
- Pioneer or their agents are not liable for any loss or expense direct or indirect arising from the failure of any part or operation of the appliance
- Operation of this appliance in violation of the warnings in this operation and installation manual will void this warranty
- It is critical the fire not be operated with worn, faulty or missing door seals. Door rope and glass seals will gradually harden over time allowing excess air to leak into the firebox, causing the appliance to 'over fire' and use more firewood during operation.
- It is critical the fire is not operated with cracked, or broken door glass
- It is critical the fire not be operated with worn, faulty or missing bricks, baffle plate or promet (white brick attached to the baffle plate)
- A claim under this warranty should be directed to the retailer who supplied the Metro fire. If this is not possible write directly to the manufacturer stating details of fault, model, serial number of your Metro, dated proof of purchase and name of retailer purchased from.

### **Warranty exclusions (This manufacturer's warranty does not cover)**

- Service calls which are not related to any defect in the product (for example: operational, installation or fuel issues). The cost of a service call will be charged if the problem is not found to be a product fault
- Defects caused by factors other than normal domestic use or use in accordance with the product's operation manual
- Defects caused through the product being operated in an 'over-fired' manner resulting in sections of the firebox operating excessively hot to the point that sections glow red.

### **Note – Overfiring your appliance will result in distortion of the firebox**

- Defects and damage to the product caused by accident, neglect, misuse or act of God
- The cost of repairs carried out by non-authorized repairers or the cost of correcting such unauthorised repairs
- Required maintenance as set out in this manual
- Surface coating deterioration through general wear and tear and lack of regular maintenance as set out in this manual.

Service under this manufacturer's warranty must be provided by a repairer authorised by Pioneer Manufacturing Ltd. Such service shall be provided during normal business hours.

---

### **Warranty** **Complete and retain these details at the time of purchase**

---

Purchase date:

Model:

Serial number:

Retailer:

Installer:

Installation date:

---

# REPLACEMENT PARTS GUIDE

Your Metro wood fire must be regularly maintained and we recommended it is also serviced annually. If a wood fire is not regularly maintained and serviced, the life span will be reduced.

If your Metro wood fire has been neglected, by not being regularly maintained and serviced, with authorised Metro parts replaced as required, your warranty may be declined.











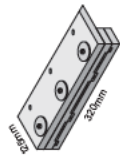



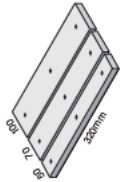

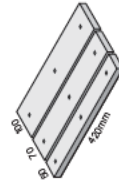

Listed below are the parts and product codes for your Metro wood fire. The promet/baffle should be regularly checked and must always be in place during the operation of your fire.

The baffle should be resting on four support lugs (two on each side of the firebox). It must be pushed hard back against the rear wall of the firebox with the promet (white brick) or return front steel edge of the baffle facing forward.

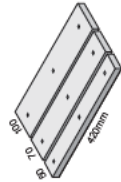
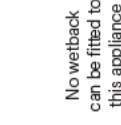



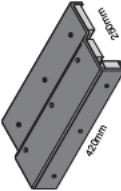





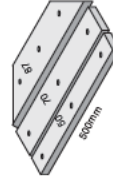



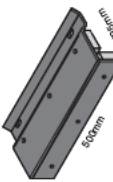



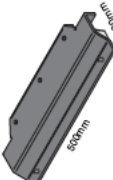



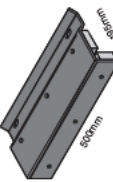



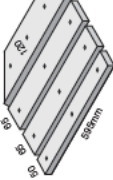



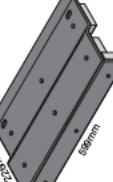



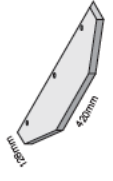



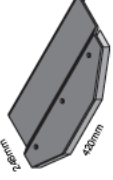



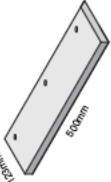





Hairline cracks in the promet extension are not uncommon and will have no adverse effect on the operation and performance of your Metro wood fire. These cracks are the result of intense heat coupled with expansion and contraction and is normal wear and tear.

If the promet extension starts to break up and pieces fall into the firebox it must be replaced.

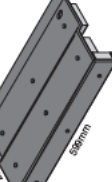
**Note: Impact damage when loading wood and burning wood which is not properly seasoned, i.e. 25% moisture content or more, will cause the promet to disintegrate and require replacement. Always burn dry well seasoned wood and take care when loading wood into the firebox.**

FREESTANDING MODELS	AIRTUBE / PROMET / BAFFLE	WETBACK	DOOR GLASS AND RETAINER	FIREBRICKS
	 Tiny Promet 500-1550	 2kW Wetback 450-0050	 Tiny Flat Glass 500-0050 Tiny Flat Glass Retainer 500-0400	 Metro Fire Brick x2 500-1100
	 Tiny Woody Promet Set 500-2004	 Side Wetback 450-0275	 Tiny Woody Flat Glass 500-0060 Tiny Woody Flat Glass Retainer 500-0410	 Metro Fire Brick x2 500-1100
	 Wee/R1 Promet Set 500-2005	 Side Wetback 450-0275	 Smart Insert/Wee Flat Glass 500-0150 Smart Insert/Wee Flat Glass Retainer 500-0500	 Metro Fire Brick x2 500-1100
	 Wee Curve Promet Set 500-2005	 No wetback can be fitted to this appliance	 Small Euro Glass 500-0300 Small Euro Glass Retainer 500-0650	 Metro Fire Brick x2 500-1100
	 Wee Curve Baffle 500-2505			
				
				

# REPLACEMENT PARTS GUIDE

FREESTANDING MODELS	AIRTUBE / PROMET / BAFFLE	WETBACK	DOOR GLASS AND RETAINER	FIREBRICKS
 Xtreme Rad Base	 Xtreme/R2 Promet Set 500-2010	 3kW Wetback 450-0100	 521mm 268mm	 Metro Fire Brick x2 500-1100
 Xtreme Rad Leg	 Xtreme/R2 Front Baffle 500-2510	 3kW Wetback 450-0100	 521mm 268mm	 Metro Fire Brick x2 500-1100
 Xtreme Rad Woody	 Xtreme/R2 Rear Baffle 500-2515	 3kW Wetback 450-0100	 521mm 268mm	 Metro Fire Brick x2 500-1100
 Xtreme Ped	 Xtreme/R2 Front Baffle 500-2510	 3kW Wetback 450-0100	 618mm 268mm	 Metro Fire Brick x2 500-1100
 Mega Rad	 Mega Rad Promet Set 500-2020	 3kW Wetback 450-0100	 618mm 268mm	 Metro Fire Brick x2 500-1100
 Mega Rad Air Tube 500-1510	 Mega Rad Front Baffle 500-2530	 3kW Wetback 450-0100	 Mega Rad Flat Glass 500-0255	 Metro Fire Brick x2 500-1100
 LTD Wee Rad Leg	 LTD Small Promet 500-1700	 4kW Wetback 450-0150	 Mega Rad Flat Glass Retainer 500-0625	 Metro Fire Brick x2 500-1100
 LTD Wee Rad Base	 LTD Small Baffle 500-2600	 3kW Wetback 450-0100	 Smart Insert/Wee Flat Glass 500-0150	 Metro Fire Brick x2 500-1100
 LTD Xtreme Rad Leg	 LTD Large Promet 500-1850	 4kW Wetback 450-0150	 Smart Insert/Wee Flat Glass Retainer 500-0500	 Metro Fire Brick x2 500-1100
 LTD Xtreme Rad Base	 LTD Large Baffle 500-2650	 3kW Wetback 450-0100	 Mega Smart/Xtreme Flat Glass 500-0200	 Metro Fire Brick x2 500-1100
 LTD Mega Rad	 Mega Rad Front Baffle 500-2530	 3kW Wetback 450-0100	 Mega Rad Flat Glass Retainer 500-0550	 Metro Fire Brick x2 500-1100
	 Mega Rad Rear Baffle 500-2535	 4kW Wetback 450-0150	 Mega Rad Flat Glass Retainer 500-0625	

## **metrofires.co.nz**

Visit the Metro website to view the full product range, find your nearest Metro stockist or simply check out the latest specifications, installation requirements and technical data.

- FREESTANDING FIRES
- INSERT & BUILT-IN FIRES
- ULTRA FIRES
- OUTDOOR FIRES
- ECO FLUES
- REPLACEMENT PARTS
- HEATING ACCESSORIES
- WETBACK SYSTEMS
- CATALOGUES AND INSTALLATION MANUALS
- NES TEST CERTIFICATES
- MAINTENANCE AND SERVICING
- PRODUCT VIDEOS AND HOW-TO GUIDES
- TROUBLESHOOTING
- FAQ'S



**metrofires**

ULTRA  FIRES

 **outdoor**

**PIONEER**  
MANUFACTURING LIMITED

19 Oropuriri Road, New Plymouth 4312  
info@metrofires.co.nz | [www.metrofires.co.nz](http://www.metrofires.co.nz)

# Standard Flue System Installation Manual

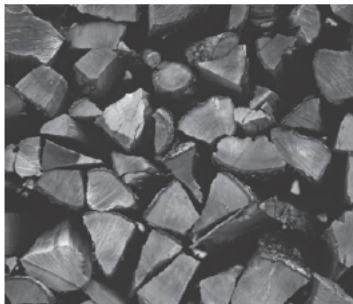

# metrofires

## Standard Flue System

Standard flue system components.....	2
Standard flue system installation .....	3
Flue system minimum heights.....	4

## **⚠ WARNING!** Important Information

**THIS FLUE KIT HAS BEEN MANUFACTURED IN ACCORDANCE WITH AS/NZS 2918 & TESTED TO APPENDIX F. TO ENSURE SAFETY THIS FLUE KIT MUST BE INSTALLED AS OUTLINED IN THESE INSTRUCTIONS AND THE APPROPRIATE REQUIREMENTS OF THE RELEVANT BUILDING CODE OR CODES.**

- Wood fire and flue clearances from combustible walls must be in accordance with the wood fire manufacturer's specifications and AS/NZS 2918.
- These installation instructions are for tested appliances only.

## **⚠ CAUTION!** Important Information

- Mixing flue system components from different sources or modifying the dimensional specification of components may result in hazardous conditions. Where such action is considered, the manufacturer should be consulted in the first instance.
- It is the responsibility of the installer to ensure that the installation of this flue kit complies with AS/NZS 2918, the appliance manufacturers specifications for flue pipe shield and ceiling plate and that the relevant building codes are adhered to.
- Bends and extensions to the length of a flue system are permitted (AS/NZS 2918 4.1)

## Standard flue system components

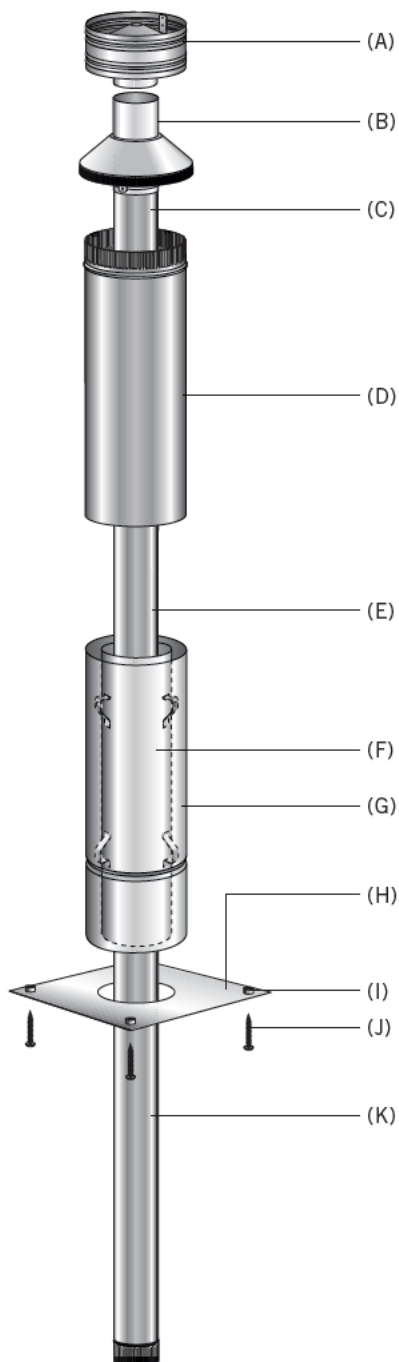

### Standard Flue System Components

- (A) 1 x Anti down-draught cowl (ADD)
- (B) 1 x Combination bracket casing cover
- (C) 1 x 405mm length of 150mm diameter stainless steel flue pipe
- (D) 1 x 1200mm x 250mm diameter galvanised outer casing slip extension
- (E) 1 x 1200mm length of 150mm diameter stainless steel flue pipe
- (F) 1 x 1190mm x 200mm diameter galvanised inner casing
- (G) 1 x 1200mm x 250mm diameter galvanised outer casing
- (H) 1 x ceiling plate (345mm x 345mm)
- (I) 4 x ceramic spacers
- (J) 4 x self tapping screws
- (K) 2 x 1200mm lengths of 150mm diameter stainless steel flue pipe painted metallic black

# Installing the flue system

1. Locate the wood fire in its proposed position and mark a point on the ceiling that is directly above the centre of the wood fire's flue spigot. Check that the wood fire's location allows the outer casing to clear all structural roof timbers.
2. Cut a 250mm square hole in ceiling. Directly above cut a hole in roof to accommodate the outer casing.
3. Fit timber nogs around ceiling. i.e. Nogs form a 250mm square aperture that allows air to circulate freely over the outer casing surface.
4. Position the outer casing so that it is flush with the underneath of the ceiling and protrudes through the roof the required height. Please Note: AS/NZS 2918 4.9.1(a) states, 'the flue pipe shall extend not less than 4.6m above the top of the floor protector'. (Refer to Diagram B).
  - a) If the flue pipe is within 3 metres of the ridge, the flue pipe must protrude at least 600mm above the ridge of the roof.
  - b) If the distance from the ridge is more than 3 metres, the flue pipe must protrude at least 1000mm above roof penetration.
  - c) The flue pipe must be more than 3 metres from any nearby structure. (Refer Diagram C).

Additional inner and outer casing may be required to ensure the following:

- i) The correct minimum roof penetration height.
- ii) Sufficient overall height to encase the flue pipe which must extend a minimum of 4.6 metres from the floor protector. Refer Diagram B.

*Please note: The inner casing should extend 200mm above roof penetration. Do not secure the outer casing slip extension onto the outer casing, as final adjustment will be required when fitting cowl assembly. See Paragraph 11.*

5. Fix an appropriate flashing around the outer casing to seal onto the roofing material. Refer to the manufacturer's recommendations for correct fitting.

*Please note: On iron roofs, fixings such as metal angle brackets (approximately 25mm x 25mm) can be fitted under the flashing to securely fix the roof to outer casing.*
6. Place the ceiling plate over wood fire flue spigot, ensuring the folded edges are facing up towards the ceiling.
7. Position the bottom length of flue pipe (crimped end downwards) into wood fire flue spigot. Refer to the manufacturer of the wood fire and use flue pipe sealant if recommended.
8. Assemble the flue pipes together ensuring seams are straight, offsetting the seams will ensure a neat fit. Flue pipes must be assembled with crimped ends down (towards wood fire). Secure each joint with a minimum of 3 monel steel rivets equally spaced around the joint. If using Hi-Therm flue pipe the protective wrapping should be left on the flue pipe during installation.
9. From the roof lower flue pipe through outer casing into the bottom flue pipe securing with three monel rivets.
10. Check that the flue pipe spacing brackets inside the inner casing are correctly positioned and then from the roof slide the inner casing into the outer casing until the brackets rest on to the internal swage ring of the outer casing, this will ensure the inner casing is the correct 12mm above ceiling level. Check the inner casing when correctly positioned extends a minimum of 200mm above the roof penetration.

11. Before securing the outer casing slip extension to the outer casing with 3 rivets, ensure the flue pipe is either flush with or extends above the top of the outer casing slip extension by no more than 15mm. Adjust slip extension to obtain this measurement.
12. Push casing cover (with spigot inside flue pipe) down onto the outer casing slip extension. The 3 locating brackets with holes must be on the outside of the outer casing slip extension and are secured using 3 rivets.
13. Fit cowl but do not secure, as removal for flue cleaning will be necessary. Deform or ovalise the stub of the cowl to ensure it is a tight friction fit.
14. Fasten ceiling plate to ceiling using screws and ceramic spacers provided. Ensure an even air gap around flue pipe when fixing. Remove protective plastic from ceiling plate.

*Please note: A 12mm air gap between ceiling plate and ceiling must be maintained.*
15. Leave all installation and operating instructions with the owner.

## Hi-therm stainless steel flue pipe

- Hi-Therm flue pipe is a high temperature, metallic black finish flue pipe designed for use on slow combustion, solid fuel heaters.
- Hi-Therm flue pipe is ideal for heaters that have high flue temperatures and that also can be operated under circumstances that may produce creosoting of Flue Pipes for short periods of time, ie, on refuelling and with air control in shut or low position. Clean air guidelines must be observed.
- Hi-Therm flue pipe is a maintainable surface finish product.

## Conditions of use

The wood fire must be operated in accordance with the manufacturer's instructions. Clean air guidelines and regulations must be observed.

- Hi-Therm flue pipe must be swept by mechanical means only. (We recommend mixed head or polypropylene brushes). Under NO circumstances should chemical flue cleaners, (soot destroyers) or steel chimney brushes be used.
- Hi-Therm flue pipe should not be used on a wood fire burning treated or wet (unseasoned) wood. Only use newspaper when lighting the fire; never burn colour printed brochures or junk mail.
- Hi-Therm flue pipes must be secured together with a minimum of three Monel Steel rivets equally spaced around the joint.

The paint finish appearance may change, depending on heater operation and is designed to be a maintainable finish. To maintain paint finish or touch up use only genuine Pioneer Aerosol. (Refer label on packaging).

Hi-Therm flue pipe can be touched up using only Pioneer metallic black aerosol paint.

Hi-Therm flue pipe must be installed in accordance with this installation instructions, using flue componentry supplied by SFP. It is the responsibility of the installer to ensure no water leaks into the Hi-Therm Flue System.

The Stainless Steel Flue Pipe used in 'Hi-Therm Stainless Steel Flue Pipe' is warranted for five years, providing the above conditions are met.

## FAILURE TO OBSERVE THESE CONDITIONS MAY NEGATE ALL PRODUCT WARRANTIES

# Minimum Heights for all Metro Flue Systems (In compliance with AS/NZS 2918)

This Standard Flue System complies with AS/NZS 2918 and its 4.6 metre height requirement (4.6 metre minimum from the top of the floor protector to the top of the flue pipe). However as external structures and the proximity of other buildings will differ for every installation, some situations will require additional flue height to comply with the standard.

Please refer to Diagrams C and D below right. (All measurements in mm)

*Please note: AS/NZS 2918 Section 4, details flue system installation requirements in full.*

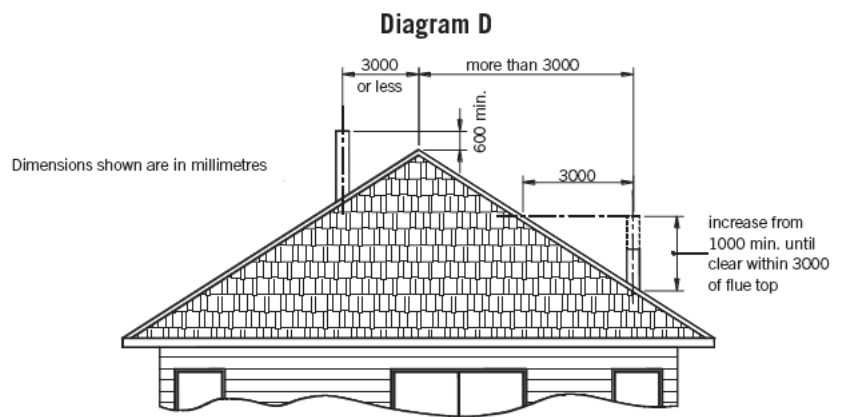
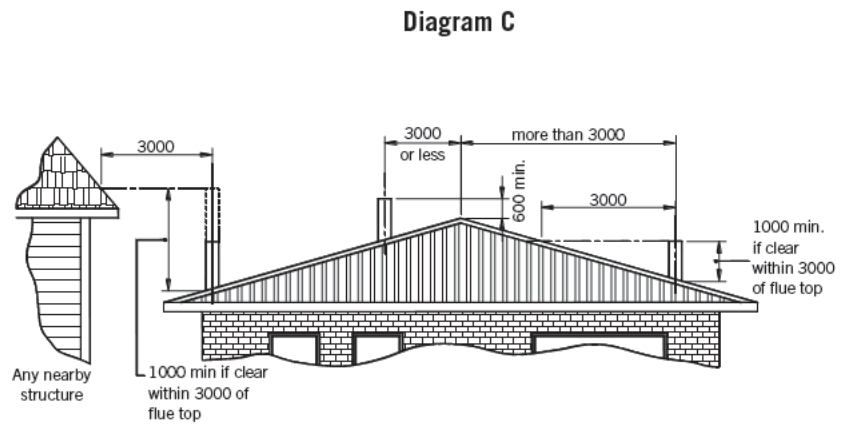
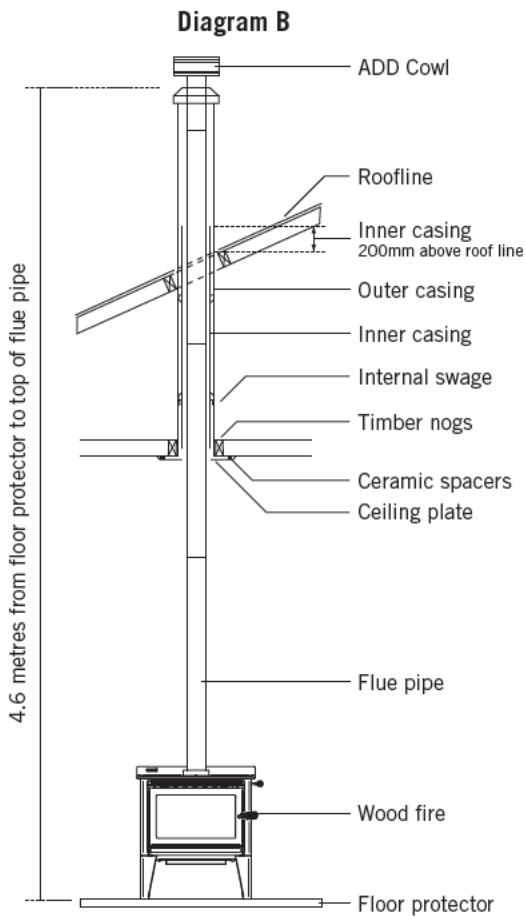



All tests reported herein have been performed in accordance with the laboratory's scope of accreditation

## Efficiency & Emissions Test Certificate

<b>Customer.</b>	<b>Pioneer Manufacturing Ltd.</b>
<b>Certification Date.</b>	Tuesday, August 30, 2016
<b>Appliance.</b>	Metro Tiny Rad Woody
<b>Tested Standard.</b>	AS/NZS 4012:2014 AS/NZS 4013:2014
<b>Test Fuel.</b>	Soft Wood (Pinus Radiata)
<b>Configuration.</b>	Free Standing
<b>Thermal Efficiency.</b>	<b>65.7 %</b>
<b>Emissions Rate.</b>	<b>0.62 g/kg or 46.9 mg/MJ</b>

*The specimen tested was identified by Spectrum with the marking #0442*

*The milligram per mega joule calculation was made in accordance with Chapter 3 of the Environment Canterbury AQL-2 document.*

### REPORT DETAILS:

<b>Prepared by.</b>	Mr. P. Chen
<b>Approved by.</b>	Mr. P. Sparrow
<b>Report Reference.</b>	#0442
<b>Release Date.</b>	August 30, 2016



Spectrum Laboratories Ltd is accredited by International Accreditation New Zealand (formerly Telarc). The Tests reported herein have been performed in accordance with the terms of our accreditation. This accreditation does not extend to any opinions or any interpretations of test results contained in this report.  
LABORATORY REGISTRATION NUMBER 962

This certificate must not be reproduced except in full. Results are based on the specimen and information submitted by the client. Spectrum Laboratories Ltd shall not be liable in respect of any loss or damage (including consequential loss or damage) resulting from the use of reports and certificates prepared by them. Results issued in electronic form are subject to confirmation by issue of a final endorsed report.



# Tiny Rad Woody

Designed for heating smaller homes and open areas, the Tiny Rad Woody features a surprisingly large volume firebox for a compact sized wood fire. Cook your favourite soup or boil the kettle on the dedicated radiant cooktop. This fire punches well above its weight with a peak heat output of 11kW and provides convenient wood storage. A small versatile fire that does it all and will provide you many years of warmth.

	Clean air approved model
Heat output	11kW peak heat output
Heating area	Heat up to 120m <sup>2</sup> / 2-3 bedroom home
Finish	Metallic black high temperature paint
Wetback	Optional Side wetback
MfE#	172397 (DRY) / 172398 (WET)
Emission	0.62gms (DRY) / 0.64gms (WET)
Efficiency	66% (DRY) / 66% (WET)
SKU	200-0175

Wall clearances

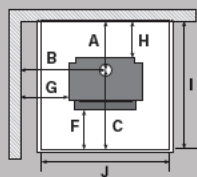

Corner clearances

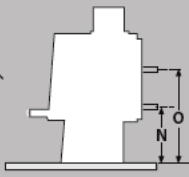
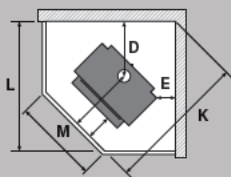

Minimum installation clearances with a Pioneer flue shield fitted (mm)

	A	B	C	D	E	F	G	H	I	J	K	L	M
	251	568	580	382	110	232	310	100	831	650	1120	870	250
Model	Width		Depth		Height		N		O				
Dimensions	515mm		498mm		758mm		365mm		555mm				

Specifications were correct at the time of printing but may alter and those detailed should be used only as a guide. If in doubt, please consult your local Metro Fires stockist. Peak heat outputs (kW) are based on the NZHHA test method using dry pine with testing undertaken by independent International Accredited New Zealand (IANZ) testing facilities.

