

# STATEMENT OF PASSING OVER INFORMATION

This information has been supplied by the vendor or the vendor's agents. Accordingly, Ownly (REAA 2008) and Sold On Kapiti Limited is merely passing over the information as supplied to us by the vendor of the vendor's agents.

We cannot guarantee its accuracy and reliability as we have not checked, audited, or reviewed the information and all the intending purchasers are advised to conduct their own due diligence investigation into the same.

To the maximum extent permitted by law Ownly (REAA 2008) and Sold On Kapiti Limited does not accept any responsibility to any person for the accuracy of the information herein.



**SOLD ON KĀPITI**  
real estate

# Independent Builders Report

Total Home Inspection Services Porirua City Ltd

Mon 18 May 2026



## **34 Clunie Ave, Raumati South, Paraparaumu, 5032, New Zealand**

Inspector: Will Suhr

For the sole purposes of Fran Fenemor

*\* unless prior agreement made with Total Home Inspection Services Porirua City Ltd*



## Date & Time

Date	Time	Weather
Mon 18 May 2026	8:00 AM	Clear Sky 10°C

## Inspector's Details

Name  
Will Suhr  
Mobile  
[021749455](tel:021749455)

## Customer's Details

Name  
Fran Fenemor  
Street Address  
[34 Clunie Ave](#)  

<u>Location</u>	<u>Email</u>
Paraparaumu	N/A

## Agent's Details

Name  
No agent specified  
Company  
N/A

## Date Generated

Date  
-

## Note

The purpose of the inspection is to identify major current deficiencies that are visually identifiable at the time of the inspection. The report shall include: grounds, structure, exterior, roofs, plumbing, electrical, interior, and insulation/ventilation. The property report does not include in depth testing of services such as, underfloor heating, specific and specialized heating systems, heat pumps, water pumps, functionality of any solar power source, swimming pool heating or alike.



Onsite Details

Onsite Inspection Details

Details

House Orientation

West facing

Height of dwelling

2 Storey

Slope of Section

Moderate  
10 to 20 Degrees

Persons Present

Owners and Inspector

## Property Details

## General, Fixtures and Landscape

### Fixtures

Garage

Single Garage

Carport

Single size timber and steel

Shed

Storage sheds - not inspected

Clothes Line

Fixed wire type

### Landscape

Driveway

Concrete & asphalt

Paths

Concrete

Stairs External

Timber & Concrete

Lawns and Gardens

Well maintained

Retaining Walls

Timber

### Landscape Gallery



The sloping driveway is in good condition

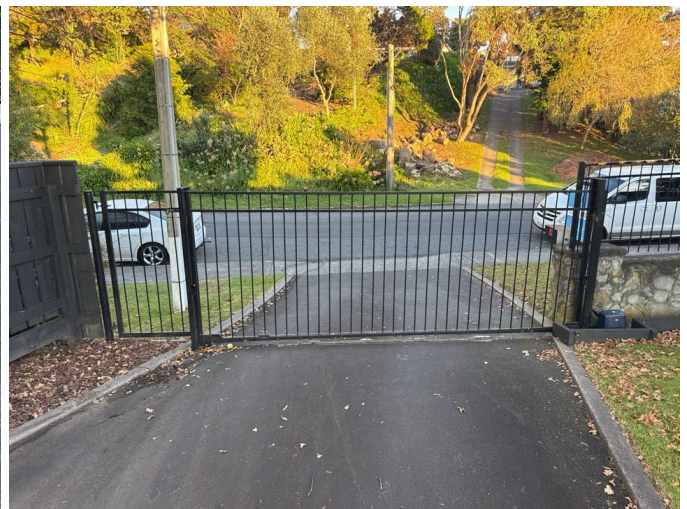

The gates to the driveway are functional. The vehicle gate is electric.



The timber stairs are secure and functional



The steel balustrade is secure



The steel and timber carport structure is showing no evidence of imminent structural issues



North side. Due to the age of the home some of the materials used in the fences construction may contain Asbestos. Safe in an inert state (well encapsulated and not disturbed) but if any repairs are needed to areas that may contain Asbestos then there are certain health and safety precautions that must be followed.



Solid timber retaining walls to the east side.  
No sign of significant movement or damage.



The condition of the pool and pumps etc were not checked as part of this inspection process. The fence is secure and the security gate is functioning. The timber deck is in good condition.



The paths are well formed and in good condition



The perimeter fencing is generally solid and intact.



## Roofing

Material Type

Concrete Tile

Finish

Pre-finished

Comment

The property features a painted concrete tile roof which has a good overall appearance. The current owners were informed by the previous owners that the roof was replaced by them therefore it should be around 12 years old. There is no documentation to prove this however. There were no visible signs of significant deterioration or active leaks at the time of inspection.

Regular inspection and maintenance will help to manage its condition, including checking and replacing any damaged or loose tiles, repairing damaged mortar and keeping gutters clear.

Inspection Method

Accessed by ladder

Condition

Average for age

## Spouting

Type

UPVC spouting

Condition

Average condition and clear at the time of the inspection

## Fascia

Type

Timber

Condition

Average / Reasonable

## Soffit Eaves

Type

Fibre Cement Sheet

Condition

It is common for fibre cement based products like the soffit linings to contain an element of Asbestos in their composition. This is of no concern in an inert state as long as the material is kept well sealed. It is in dust form when it poses a potential hazard. Care must be taken during the prep stage before painting or if fittings are being installed.

## Chimney

Type

Concrete

Type

Decommissioned

## Roofing Gallery



The concrete tile roof has a good overall appearance



The spouting is in an average condition and was clear. The effectiveness of the spouting will need to be checked during rainy periods. Due to the dry conditions that were evident on the day of our inspection we cannot comment on any leaks that maybe evident to the spouting or down pipes.



The ridge caps tiles are sealed with mortar which is prone to cracking. Well maintained current condition noted. Periodic monitoring is required. When cracking becomes evident, engage a roof rejuvenation professional to re-point any areas of concern.



The roof penetrations were effectively sealed at the time of the inspection



The decommissioned concrete chimney was intact and solid at the time of inspection. There was no evidence of cracking or structural concerns. The condition of the chimney should be checked after earthquakes.



There are a few cracked tiles which have been sealed with sealant. The cracks are in a low risk area however they will need to be monitored.



The Lichen should be chemically treated to prevent it spreading. A chemical treatment may be required every 2-3 years as part of ongoing roof maintenance. Lichen will speed up deterioration to the roof surface and will need to be monitored and treated as required.



There is one rust hole to the carport roof which requires a patch repair.



Spare roof tiles stored in the sub floor for future maintenance



## Cladding

### Cladding Primary

Type	Finish
Timber bevelback Weatherboards (direct fixed)	Paint
Condition	Comment
Average / Reasonable	The home is clad with timber weatherboards which show general signs of paint deterioration. While no significant failure was noted, the cladding will require ongoing maintenance to protect the timber. A thorough prep and repaint is recommended in the near future to maintain weather protection and extend the life of the cladding. Exterior cladding should be painted at approximately 8-10 year intervals in exposed UV areas. Intervals can stretch for low UV exposed areas.

### Cladding Secondary

Type	Finish
N/A	N/A
Condition	Comment
N/A	N/A

### Window Cladding

Type	Flashings
A combination of single glazed timber, aluminium and double glazed aluminium	Fitted where required
Condition	Comment
Exterior is in average condition	The timber windows and doors are due for a thorough prep and paint upgrade. Rust affected head flashings should be thoroughly prepped, treated with rust converter and painted or replaced. Windows and doors are considered a weather tightness risk area and a good seal must be maintained at all times. At the time of the inspection all non invasive moisture checks completed beneath the windows and doors were within the normal range.

### Cladding Gallery



The front faces to the



Windows rebated into the concrete foundation walls are effectively sealed



There was no evidence of damage or movement to the concrete chimney



Example. Early stage surface deterioration to the paint in some areas.



Good clearance between the deck and the cladding which will allow water to drain away.



The North side



The steel roof supports are solid and secure



Timber in close contact with the ground is at risk of premature deterioration and must be kept thoroughly sealed. Paint improvements are recommended anywhere that surface wear is present.



Dog door installed



The typical single glazed aluminium window detail consists of head and sill flashings and timber scribes.



Paint deterioration to the timber scribes



Timber windows are generally detailed with a head flashing and sill



Good paint quality to the timber fascia and fibre cement soffit linings



The East side



The South side



It is not recommended to directly fix objects through the cladding as the fixing points are a weather tightness risk. A builder should modify the detail to prevent the risk of potential issues. There was no evidence of failure found.



Good ground clearance around the perimeter. The current building code requires a 150mm clearance between the internal floor height and the sealed ground and 225mm to unsealed ground.



Paint deterioration to the timber joinery in some areas



The owner disclosed that this door is to be replaced. The damaged weatherboard beneath should also be replaced.

Some of the homes head flashings have superficial corrosion. This will get worse if left and requires the corrosion to be removed before sealing with rust converter and painting. Risk of water ingress issues if left to deteriorate.



Installing an angled weather trim at the base of these 2 doors would be a good improvement as the angle would deflect water away from the threshold.

Rust affected hinges should be treated with rust converter or replaced



## Foundations

### Perimeter

Type	Condition
Concrete ring foundation	Typical for age. No structural concerns sighted.

### Internal

Type	Condition
Concrete Piles and suspended timber floor	No current concerns sighted

### Base Cladding

Type	Condition
None	N/A

### External Ventilation

Type	Ground Condition
Vents in foundation	Dry at time of inspection

### Flooring

Type	Condition
T&G flooring	Mostly covered by the insulation and floor linings

### Access or Doors

Position	Condition
Through storage room	Reasonable access

### Bearers/Joints

Type and Condition	Comments
Wire connections	There were no concerns with the sub floor framing or connection method at the time of inspection

### Foundations Gallery



The concrete ring foundation is in a typical condition for the age. No sign of cracking or significant stress.



The concrete piles are solid at the time of inspection. Galvanised wire connects the bearers to the piles and anchors the structure to the ground.



Polyester insulation is installed in the sub floor. There is no labelling present to indicate the R-Value of the material.

The thermal resistance rating or R-Value is the measure used most commonly in the building and construction industry to determine a material's ability to resist the transfer of heat. The higher the R-Value the better thermal resistance the product will provide.



There was no evidence of significant water runoff to the sub floor



## Services

## Security

Burglar Alarm

Yes but not tested

Exterior Lights

Exterior lights noted

Smoke Sensors

Yes and in a working condition at the time of inspection. Regular testing recommended.

Security Window Locks

None

Alarm Control Panel

Inside entrance

Security Lights

Security lights noted

Security Door Locks

Security doors by the deck/pool

## Security Gallery

N/A

## Electrical

Power Connection

Under ground

Meter Board Condition

Average for age

Switch Board Type

Circuit breaker board

Meter Board Position

South side

Switch Board Position

Garage

### Electrical Gallery



The meter board appears to be sufficiently sealed at the time of inspection. Smart meter installed, no obvious concerns sighted.



A visual inspection of the electrical system did not show any evidence of electrical overload to switches or power points. Cover plate(s) were not removed and the wiring behind the distribution board not inspected. This is beyond our scope of expertise. Please note. The assessor is not a registered electrician; no electrical safety tests or electrical component tests were undertaken. Power points, lights and switch testing therefore does not form part of this report.



North side.

The electrical earth rod provides a safe path for fault currents to dissipate into the ground, helping protect people and equipment from electric shock and reducing the risk of damage during faults or lightning strikes.

An earth loop test should be considered to determine the earths effectiveness.

Only modern TPS wiring sighted during the inspection.

## Plumbing

### External Plumbing

Drainage Under Floor

Sufficiently supported

Section Run Off

There was no evidence of significant water runoff issues to the property and there were no previous issues disclosed by the owners

Downpipes

UPVC

Gas Meter Position

There is no gas supply to the house currently

Gully Traps

No sign of blockages or recent overflows

Stormwater

T.H.I.S is unable to comment on the condition of the underground drains and services due to them being concealed. The only way to determine the condition of the pipes is via a camera inspection.

Driveway Paving Sump

None

Toby Position

Front of property

### Internal Plumbing

General Condition

Good. No plumbing issues could be found.

Type

Only Buteline and Copper pipes sighted. Not all areas of the general structure could be viewed due to the lack of access. Unable to fully view and comment on all plumbing types due to this.

### Plumbing Gallery



The South spouting is damaged and has been repaired with sealant. This area should be monitored over time and will need to be eventually replaced.



There was no evidence of current leaks under the plumbed areas

## Water Heating

System - Header Tank

System - Header Tank Tray

Mains Pressure

Not applicable

Unit - Condition

Unit - Year of Manufacture

Average appearance

2023

### Water Heating Gallery



Hallway cupboard.  
 Rheem 177L Mains Pressure Electric Hot Water Cylinder. Seismic restraints installed.  
 The pressure-reducing valve that is located at the top of the mains pressure hot water cylinder should be tested every 6 months or in accordance with the manufacturer's instructions to make sure that it is in working order.



No sign of leaks around the base of the cylinder. The cylinder is placed in a safe tray with a drainage outlet as required.

## Bathrooms

### Bathroom

Name

Bathroom

Bath

Acrylic

Toilet

No toilet

Heater

Heated towel rail

Moisture Scanning

Common failure areas examined. No unusual readings taken

Shower

Acrylic lining and base with aluminium frame, glass panel and door

Vanity Unit

Pre-finished type

Tapware

Good working condition

Ventilation

Mechanical ventilation

Comments

The bathroom has been generally well maintained and is in good condition. There were no concerns found at the time of inspection.



The rear edge of the vanity is well sealed. The tap is functioning well. No concerns with the water feeds or waste under the vanity



The perimeter of the bath is well sealed. The tap is functioning well.



The base of the shower is well sealed. There was no evidence of damage to the shower base at the time of the inspection.



Good water pressure noted. There is some early stage paint deterioration around the top of the wall above the shower frame which will require attention in the near future.

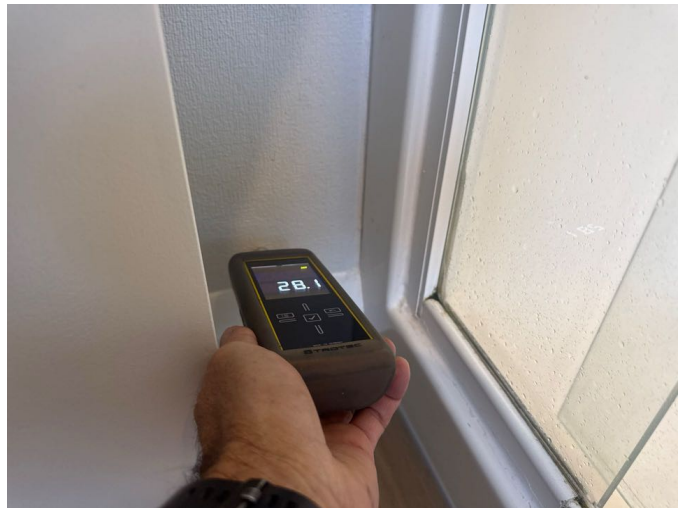

The common fail areas of the shower and plumbed areas were checked for elevated moisture. Moisture levels were within the normal range.



## Ceiling Cavities

### Ceiling Cavity

Name	Roof Type
Ceiling Cavity	Pitched Roof
Roof Condition	Insulation Type
Average for the age	Fibreglass Batts
Insulation Comments	Hatch Type
The ceiling cavity is in a typical condition for the age and type. There were no significant concerns sighted at the time of the inspection.	Hatch
Hatch Location	Vermin Type
Hallway	None Sighted
Vermin Comments	
Poison and traps in place in the ceiling cavity. Ongoing monitoring is required.	

### Ceiling Space / Borer

Roof Structure	Trims
No live activity sighted	No live activity sighted
Exterior Cladding	Subfloor
No live activity sighted	No live activity sighted
Comments	
Any exposed timber framing should be monitored over time for borer activity. Recent activity can be identified by small mounds of 'frass' (wood dust) which is caused by the emerging adult beetles. If activity is noticed in the future, a pest industry professional should be engaged for further assessment and remediation. Structural deterioration is a risk if further assessment is not carried out.	



There was no evidence of current or past moisture ingress issues under the roof framing or linings (where accessible) at the time of inspection. The roof framing structure appears to be solid.



Batt type insulation installed. There was no labelling present to indicate the R-Value of the material. The thermal resistance rating or R-Value is the measure used most commonly in the building and construction industry to determine a material's ability to resist the transfer of heat. The higher the R-Value the better thermal resistance the product will provide.



The ducted Heatpump systems internal unit is located in the ceiling cavity. Information relating to any future servicing requirements should be made available for purchasers.



Extraction units vented to the exterior. The roof penetrations were effectively sealed at the time of the inspection.

Decks

Deck

Name

Deck

Category

Low risk construction

Comments

Good modern construction materials and building methods used. Solidly built and no concerns sighted.

Construction Type

Timber

Condition

Good



No concerns with the framing structure. Solid and well connected.



The balustrade is solid and connected sufficiently at the base



The timber decking is in good condition

## Kitchens

### Kitchen

Name

Kitchen

Elements

Electric / separate bench top

Dishwasher

Yes but not tested

Benchtops

Formica

Tapware

Good working order

Moisture Scanning

Common failure areas examined. No unusual readings taken

Oven

Under bench oven

Rangehood Extract

Vented to exterior

Waste Disposal

No waste disposal

Sinks

Stainless steel

Units

Melteca

Comments

The kitchen has been well cared for and is in good condition. No concerns sighted.



The rear edge of the bench top is well sealed. The tap is functioning well. No concerns with the water feeds or waste pipes under the sink.



The kitchen cabinetry and vinyl floor are in good condition



The range hood extraction unit is functioning

Laundries

Laundry

Name

Laundry Tub

Laundry

Double stainless steel tubs with timber cabinet

Washing Machine Waste

Tapware

Integrated into tub

Average for age

Dryer Vent

Other Fittings

None

No other fittings sighted

Heating

Ventilation

No heating

Passive window ventilation

Mositure Scanning

Comments

Unable to effectively moisture scan the walls due to the concrete construction

The laundry is in a tidy and functional condition. There were no concerns found.



The laundry tubs are tidy and functional



No concerns with the waste or water feeds beneath the tub



Concrete walls and floor noted. These areas could not be moisture scanned. The painted interior is tidy.

## Living

## Living

### Room Type

Living

### Wall Linings

Painted plaster board

### Internal Doors

Hollow core

### Ventilation Ducting

Passive window ventilation

### Mositure Scanning

Common failure areas examined. No unusual readings taken

### Floor Coverings

Carpet

### Ceiling Linings

Painted plaster board

### External Doors

Double Glazed Aluminium bifold door

Single Glazed Aluminium Sliding Door

Timber glazed front door

### Heating

Ducted Heatpump system

### Comments

Generally tidy and well maintained condition. The broken window handle should be replaced.

## Living Gallery



Heating is provided by a ducted Heatpump system and ceiling vents



Doors and windows are functional



The broken window handle should be replaced



The wall and ceiling linings and carpet are in good condition



Moisture levels to the external walls were within the normal range at the time of inspection

## Office

Room Type

Office

Wall Linings

Wallpaper on Plasterboard (assumed)

Internal Doors

Hollow core

Ventilation Ducting

Passive window ventilation

Mositure Scanning

Common failure areas examined. No unusual readings taken

Floor Coverings

Carpet

Ceiling Linings

Painted plaster board

External Doors

No external doors

Heating

Ducted Heatpump system

Electric Heater

Comments

Generally tidy and well maintained condition

## Living Gallery



The heating appliances are not tested as part of the inspection process.



The internal doors are functioning well. Door stops installed behind the doors.



Part of the window hardware is missing from the framing which prevents the window from sealing effectively. These can be retro fitted which will help improve the seal. Maintenance recommended.



Fixed cabinet noted



Moisture levels to the external walls were within the normal range at the time of inspection

## Bedrooms

### Room Type

Bedrooms

### Wall Linings

Wallpaper on Plasterboard (assumed)

### Internal Doors

Hollow core

### Ventilation Ducting

Passive window ventilation

### Mositure Scanning

Common failure areas examined. No unusual readings taken

### Floor Coverings

Carpet

### Ceiling Linings

Painted plaster board

### External Doors

Single Glazed Aluminium Sliding Doors to bedrooms 2 & 3

### Heating

Ducted Heatpump system

### Comments

The interior has been well maintained over time and is in good overall condition. Minimal wear and tear sighted.

## Living Gallery



Bedroom 1



The sliding door and windows are functional



The internal doors are functioning well. Door stops should be installed where missing to prevent the risk of damage to the wall linings (some damage present).



Moisture levels to the external walls were within the normal range at the time of inspection



Bedroom 2



The sliding door is functioning. Security door noted.



The timber windows are functional



Moisture levels to the external walls were within the normal range at the time of inspection



Bedroom 3



The wall and ceiling linings and carpet are in good condition



Moisture levels to the external walls were within the normal range at the time of inspection

Toilets

Toilet

Name

Toilet

Toilet

Dual flush china/acrylic

Vanity Unit

Tapware

Sink only

Average for age

Heating

Ventilation

No heating

Passive window ventilation

Comments

Moisture Scanning

The toilet (room) is tidy and has been well maintained. The toilet and sink are well sealed and functioning well.

Common failure areas examined. No unusual readings taken



The sink is well sealed to the wall. The taps are functioning well. No visible concerns with the water feeds or waste beneath the sink.

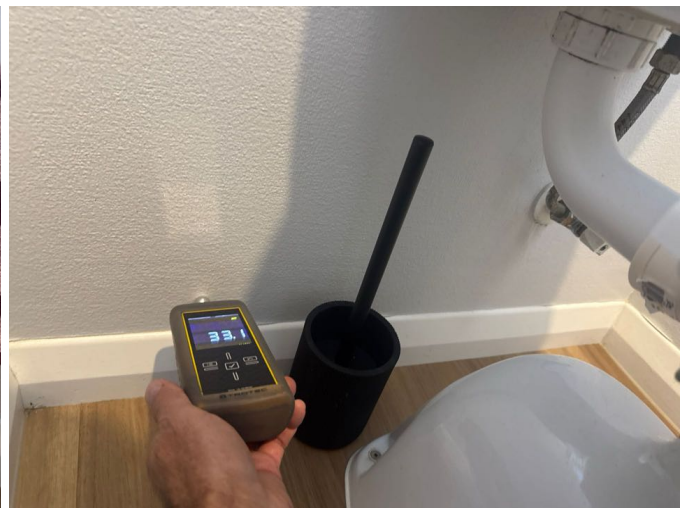

The base of the toilet is well sealed and is secure. The toilet is in a functioning condition.

Moisture levels behind the toilet were within the normal range at the time of inspection

## Galleries

### Gallery

Name

Gallery



Not all areas of the garage could be fully inspected due to the presence of stored items. A full inspection is recommended once cleared. This applies to all concealed locations throughout the house.



The electric garage door is functioning



Large storeroom to the side of the garage



Potential office also next to the garage. No concerns found.

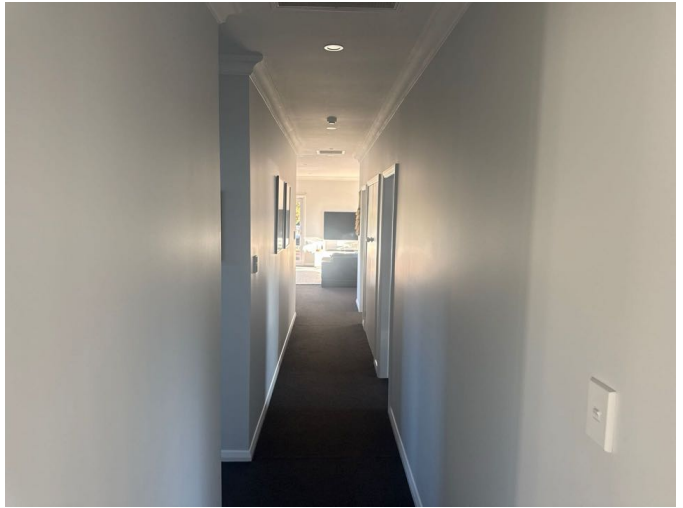

The control panel for the ducted system is located in the dining area. Untested. The hallway is tidy



## Overview

## Overview

### Overview Comments

The council property file was not viewed as part of the inspection. T.H.I.S recommends the council property file be viewed by purchasers as part of their due diligence.

The 2 level timber frame dwelling has a 160m<sup>2</sup> floor area and 1231m<sup>2</sup> section. The home has 3 bedrooms, an office and 1 bathroom with separate toilet. The sloping section is fully enclosed by fencing and gates. The front faces to the West.

The dwelling was constructed in 1952 and many of the original materials appear to have remained serviceable well beyond the minimum durability requirements of the current New Zealand Building Code (typically 5, 15 or 50 years, depending on the element). This suggests the materials and construction have performed well over time. However, as the building is now several decades old, ongoing maintenance and periodic replacement of materials should be expected. No assurance can be given as to the remaining serviceable life of original components. The home is in a good overall condition for the age and is generally tidy throughout.

General maintenance is advised to a few areas which will prevent the risk of more costly repairs in the future.

The main areas of risk and recommended maintenance are listed below but the report should be read and understood in full.

**Weatherboards** - The timber weatherboards show general signs of paint deterioration. While no significant failure was noted, the cladding will require ongoing maintenance to protect the timber. A thorough prep and repaint is recommended in the near future to maintain weather protection and extend the life of the cladding.

**Timber Windows & Doors** - The timber windows and doors are due for a thorough prep and paint upgrade. Rust affected head flashings should be thoroughly prepped, treated with rust converter and painted or replaced.

This was a visual inspection using a non invasive moisture meter (Trotec T660), which has limitations. The meter used measures to a depth of 40mm. The numbers observed on the screen are a scale of electrical activity (dielectric constant), not a percentage. Moisture readings can be taken as an indication only and any recommendations are based on visually available evidence and the inspectors knowledge of building materials and risk areas. Readings on the moisture meter can be affected by items such as metal straps, fixings, the density of materials and condensation. Elevated moisture is generally documented once we have conducted our own due diligence in determining its relevance.

Should further investigation, advice or remediation be recommended in the course of this inspection, a suitably qualified professional should be sought, to advise on the state of any and all similar issues throughout the property.

Failure to do so, T.H.I.S accepts no liability relating to any claim regarding any/all items recommended for further investigation or remediation.

Please note that this report does not provide any guarantee that items/areas inspected will not fail at a later date. Information within the report pertains strictly to observations on the day of the inspection.



This report should be seen as a reasonable attempt to identify any significant defects at the time of the visual inspection. While some minor defects maybe noted, it is unrealistic for the inspector to comment on all minor imperfections in this standard property inspection report.

Any structure constructed prior to 01 January 2000 may contain asbestos. Materials that contain asbestos were widely used for plastering internal ceiling linings, claddings, soffit linings, floor coverings and many other products / materials that are evident within a building / dwelling. Care must be taken with these materials and testing **MUST** be performed if there is any doubt that asbestos may be evident. Do not sand, cut, drill or damage any material that may contain asbestos. Testing should always be performed if in doubt.

The home was also constructed in an era when lead based paint was used. This can pose a health risk when sanded/removed and should be tested prior to any improvements.

N/A

## Status

### Site Status

Inspected

### Exterior Status

Inspected

### Roof Space Status

Viewed where possible

### Services Status

Partially inspected

### Subfloor Status

The foundation was inspected where possible

### Roof Exterior Status

Viewed from the ground only

### Interior Status

Viewed where possible. Some locations were concealed by furniture and general belongings.

### Accessory Unit Status

Briefed over

## Certificate

### CERTIFICATE OF INSPECTION IN ACCORDANCE WITH NZS 4306:2005

**Client:** Fran Fenemor

**Site Address:** 34 Clunie Ave, Raumati South, Paraparaumu, 5032, New Zealand

**Inspector:** Will Suhr

**Company:** Total Home Inspection Services Porirua City Ltd

**Qualification:** Registered member of the New Zealand Institute of Building Inspectors (NZIBI), Qualified Builder, Licensed Building Practitioner, member of the New Zealand Institute of Building Inspectors (NZIBI), Qualified & Licensed Builder

**Overview Comments:** The council property file was not viewed as part of the inspection. T.H.I.S recommends the council property file be viewed by purchasers as part of their due diligence. The 2 level timber frame dwelling has a 160m<sup>2</sup> floor area and 1231m<sup>2</sup> section. The home has 3 bedrooms, an office and 1 bathroom with separate toilet. The sloping section is fully enclosed by fencing and gates. The front faces to the West. The dwelling was constructed in 1952 and many of the original materials appear to have remained serviceable well beyond the minimum durability requirements of the current New Zealand Building Code (typically 5, 15 or 50 years, depending on the element). This suggests the materials and construction have performed well over time. However, as the building is now several decades old, ongoing maintenance and periodic replacement of materials should be expected. No assurance can be given as to the remaining serviceable life of original components. The home is in a good overall condition for the age and is generally tidy throughout. General maintenance is advised to a few areas which will prevent the risk of more costly repairs in the future. The main areas of risk and recommended maintenance are listed below but the report should be read and understood in full. Weatherboards - The timber weatherboards show general signs of paint deterioration. While no significant failure was noted, the cladding will require ongoing maintenance to protect the timber. A thorough prep and repaint is recommended in the near future to maintain weather protection and extend the life of the cladding. Timber Windows & Doors - The timber windows and doors are due for a thorough prep and paint upgrade. Rust affected head flashings should be thoroughly prepped, treated with rust converter and painted or replaced. This was a visual inspection using a non invasive moisture meter (Trotec T660), which has limitations. The meter used measures to a depth of 40mm. The numbers observed on the screen are a scale of electrical activity (dielectric constant), not a percentage. Moisture readings can be taken as an indication only and any recommendations are based on visually available evidence and the inspectors knowledge of building materials and risk areas. Readings on the moisture meter can be affected by items such as metal straps, fixings, the density of materials and condensation. Elevated moisture is generally documented once we have conducted our own due diligence in determining its relevance. Should further investigation, advice or remediation be recommended in the course of this inspection, a suitably qualified professional should be sought, to advise on the state of any and all similar issues through out the property. Failure to do so, T.H.I.S accepts no liability relating to any claim regarding any/all items recommended for further investigation or remediation. Please note that this report does not provide any guarantee that items/areas inspected will not fail at a later date. Information within the report pertains strictly to observations on the day of the inspection. This report should be seen as a reasonable attempt to identify any significant defects at the time of the visual inspection. While some minor defects maybe noted, it is unrealistic for the inspector to comment on all minor imperfections in this standard property inspection report. Any structure constructed prior to 01 January 2000 may contain asbestos. Materials that contain asbestos were widely used for plastering internal ceiling linings, claddings, soffit linings, floor coverings and many other products / materials that are evident within a building / dwelling. Care must be taken with these materials and testing MUST be performed if there is any doubt that



asbestos may be evident. Do not sand, cut, drill or damage any material that may contain asbestos. Testing should always be performed if in doubt. The home was also constructed in an era when lead based paint was used. This can pose a health risk when sanded/removed and should be tested prior to any improvements.

**Site Status:** Inspected

**Subfloor Status:** The foundation was inspected where possible

**Exterior Status:** Inspected

**Roof Exterior Status:** Viewed from the ground only

**Roof Space Status:** Viewed where possible

**Interior Status:** Viewed where possible. Some locations were concealed by furniture and general belongings.

**Services Status:** Partially inspected

**Accessory Unit Status:** Briefed over

Any limitations to the coverage of the inspection are detailed in the written report.

### **Certification**

I hereby certify that I have carried out the inspection of the property site at the above address in accordance with NZS 4306:2005 Residential Property Inspection - and I am competent to undertake this inspection.

Inspector: Will Suhr

Date: Mon 18 May 2026

An inspection carried out in accordance with NZS 4306:2005 is not a statement that a property complies with requirements of any Act, regulation or bylaw, nor is the report a warranty against any problems developing after the date of the property report. Refer to NZS 4306:2005 for full details.

## SECTION 1 - SCOPE OF INSPECTION

The scope of the inspection is limited to visual inspection of the standard components of the home, which the inspector has reasonable access to and is the inspector's clear line of sight. The purpose of the inspection is to identify major current deficiencies that are visually identifiable at the time of the inspection. The report shall include: grounds, structure, exterior, roofs, plumbing, electrical, interior, and insulation/ventilation; the procedure for their inspection will be conducted in accordance with NZS 4306:2005. New Zealand Standard, Residential Property Inspection. We also offer an invasive inspection, using digital imaging to inspect spaces behind walls. We are the innovators and developers of this type of inspection. This was brought to the market by us to allow for more in-depth reporting. If you have contracted us to prepare an invasive inspection report, this comprises a visual inspection (as set out above) together with cutting holes in the interior lining in specific areas, and using digital imaging to inspect the areas behind the internal linings. The invasive inspection is limited to the specific areas only that have been invasively accessed and visually documented and commented on in the body of the report.

## SECTION 2 - LIMITATIONS OF INSPECTION AND REPORT (GENERAL)

The purpose of the inspection (including the invasive inspection) is to report on the condition of building elements. The report is not a guarantee, warranty, or any form of insurance, and is not to be used as a substitute for a final walk-through inspection, or a comprehensive building survey. This report is not a technically exhaustive investigation nor is it practicable to identify and itemise every defect. The purpose of the report is to identify any readily visible items of concern at the time of the inspection. The report assumes that the property as built complies with the building code and does not investigate or comment on that.

This report:

- Does not assess or certify that the property or any element of it complies with the Building code (current or at the time the building was constructed).
- Does not advise on, or cover, zoning ordinance violation, geological stability, soil conditions, structural stability, engineering analysis, termites or other infestations, asbestos, formaldehyde, water or air contaminants of any kind, toxic molds, rotting (non-visual), electromagnetic radiation, environmental hazards.
- Does not appraise or assess the property value, or the cost of any repair work,
- Does not cover detached buildings, sheds, underground condition of pool and spa bodies and related piping, private water systems, septic systems, saunas, specialised electronic controls of any kind, elevators, dumb waiters, water softener and purification systems, solar systems, internal system components, security systems, system adequacy or efficiency, prediction of life expectancy of any items or system, minor and/or cosmetic problems, latent or concealed defects or any items marked as not inspected within the report.
- Does not cover areas that are concealed, contained, inaccessible, or cannot be seen, due to walls, ceilings, floors, insulation, soils, vegetation, furniture, stored items, systems, appliances.
- Does not detect or comment on the existence of formaldehyde, lead paint, asbestos, toxic or flammable materials, pest infestation and other health or environmental hazards;
- Does not investigate any underground drainage or plumbing, playground equipment, the efficiency measurement or insulation or heating and cooling equipment, vehicles, or any other object, will not be inspected or included in the report.
- Does not comment on Appliances and spa/pool equipment special cycles or features.

## SECTION 3 – LIMITATIONS OF INSPECTION AND REPORT (WEATHER-TIGHTNESS)

In accordance with NZS 4306:2005 this report provides some general information about weather-tightness risks in relation to the property inspected and where appropriate comments on specific high risk design aspects, issues, or defects that are readily visible and fall within the scope of inspection. Moisture scanning has been undertaken as part of this report and the report may pick up and comment on risk factors as part of a visual inspection, but this is indicative only and is not a reliable or determinative method of detecting moisture ingress. This report cannot, and does not, provide advice or investigation about whether the property inspected is a leaky home, suffers from toxic mold, rot, or fungal growth, or complies with E2/AS1 of the Building Code. This report is not to be construed as advice about the overall weather-tightness of the property or whether the property is, or is likely to be, stigmatised as a leaky home.

The nature of the leaky home problem in New Zealand means:

- Systemic moisture ingress, or building defects making a building prone to leaking, which would stigmatise a building as a 'leaky home', in many cases can only be detected through a comprehensive building survey including destructive testing and external cladding removal. That is outside the scope of this inspection and report.
- presence of risk factors, or areas of elevated moisture readings, identified in this report, are intended to do no more than to alert the customer to issues that might need to be investigated further. They are not to be equated with advice that a property is or is not a leaky home.
- The absence of visible risk factors or elevated moisture readings is not intended to (and cannot reliably be taken as) advice that the property is not a leaky home. If the client is concerned about weather-tightness, and particularly if the property inspected has areas of monolithic cladding, the client should obtain a comprehensive weather-tightness investigation from a building surveyor.

#### SECTION 4 - REASONABLE ACCESS

Reasonable access is access that is safe, unobstructed and which has a minimum clearance of 450 x 400 mm opening access door that can be safely accessed from a 3.6 m ladder and a minimum crawl space of 610 x 610 mm in the ceiling space and 500 x 400 mm opening access door and a minimum crawl space of 500mm vertical clearance for the sub floor area. Roofs are able to be safely accessed from a 3.6 m ladder. (Or if the minimum clearance is not available, the area is within the inspector's unobstructed line of vision).

Should THIS (Total Home Inspection Services) be unable to physically access the roof, the inspector may employ a drone to perform a visual assessment of elevated areas. This inspection focuses on the roof's surface, aiming to spot any significant visible flaws and potential issues. The client should recognise the inherent limitations of drone inspections, as the inspector does not physically traverse the roof. THIS NZ will review the images captured and offer recommendations for any necessary or advisable further actions. The client agrees and understands that some defects, which might be detected through direct roof access, may go unnoticed in drone inspections. THIS NZ will need authorisation from the property owner and any relevant parties of adjoining properties to conduct drone operations. Additional charges apply for drone inspections.

#### SECTION 5 - VENDOR INSPECTIONS

The vendor is required to inform the inspector of any existing issues that they are aware of that have been an issue in the past or may become an issue in the future or at the time of the inspection.

#### SECTION 6 – CONFIDENTIALITY AND LIMITATION OF LIABILITY

The contents of the report, or any other work prepared by us is confidential and has been prepared solely for you and shall not be relied upon by any third parties. We accept no responsibility for anything done or not done by any third party in reliance, whether wholly or partially, on any of the contents of the report. Subject to any statutory provisions, if we become liable to you, for any reason, for any loss, damage, harm or injury in any way connected with the completion of the Inspection and/or report, our liability shall be limited to a sum not exceeding the cost of the Inspection and report. We will not be liable to you for any consequential loss of whatever nature suffered by you or any other person injured and indemnify us in respect of any claims concerning any such loss.

#### SECTION 7 – CANCELLATION POLICY

To ensure efficient service and use of resources, we require notice of cancellation at least 24 hours prior to the scheduled inspection date and time. If you cancel your appointment less than 24 hours before it is due to take place, you will incur a cancellation fee of \$150 +gst. This fee compensates for the preparation and scheduling adjustments made in anticipation of the inspection. Please notify us as soon as possible if you need to reschedule or cancel your appointment to avoid this charge.

## Glossary:

### Electrical / General

Plugs, switches, and light fittings are sighted where possible for damage or poor fixing back to the wall linings. Power points are not tested.

### Good

Is given when the item is believed to be in new or near new condition, or is better than would be expected given the age of the property.

### Generally Good

Used as an overall comment to summarise the general condition of the item being checked.

### Average / Reasonable

When the condition is at the standard expected given the age of the house. Some wear and tear would be expected but is still in serviceable order.

### Poor

The condition is below the standard expected. There is damage or excessive wear. Replacement or maintenance is required.

### Hardware

Cat doors and window handles, hinges to windows, doors and cupboards.

### Deck Over Living

Deck built within the exterior wall line. Decked area is often the ceiling of a room or garage below.

### External Deck

Deck built outside the exterior wall line. May be cantilevered or attached to the house and supported on posts or piles.

### Header Tank

Small tank which supplies water to low pressure hot water cylinders, normally located on the roof or in the ceiling space.

### Cladding

Exterior wall linings.

### Gully Trap

Collection point outside the building line for waste water. Is connected to the sewerage system.

### Water Toby

Tap or shut off valve usually at the point where the water supply enters the property.

### Soffit / Eaves

Horizontal or pitched linings under the roof overhang.

### Fascia

Timber or pre-finished metal facings at the end of the roof line.

## Council Property File:

### Lim Report

"Land information Memorandum" is a computer generated print out of some of the information the council holds on file, mostly pertaining to the "land". If there are any problems or unusual important features, these should show up. For instance, the LIM might reveal the property is subject to flooding, or contains a council drain which may not be built over, or a protected tree or building. It should also help you to figure out how the district plan applies to the site. Sometimes the council will also supply pages of area plans showing the known storm water and sewage drains, zoning and other details.

### Property File

This is a file that is held at council which contains documents relating to any buildings on that site. However, the council only has records of works it knows about. Frequently alterations have been done to older houses without council knowledge.

### Recommendation

Checking the Council property file for any property is recommended as part of due diligence.

### Comment for this property

Recommend viewing of Council Building file.

# MOISTURE DETECTION METHODS

The inspector has conducted moisture scanning of the home detailed in this report, whilst performing a detailed building inspection. This is the only method used when the inspector is performing a Pre-purchase inspection or an Independent Builders Report. Areas of typical concern such as around windows, around external doors, and along the interior of exterior walls where accessible, have been scanned with a non-invasive Protimeter moisture meter. This method, combined with the experience and training of our inspector can help to ascertain any levels of moisture within the wall cavity. Levels over 20% are considered high for more modern homes, while older homes can have a reading of around this level without concern. The fibre saturation point of older timbers (Rimu, etc.) are higher. In our experience we have found that percentage readings can be inaccurate and often misleading. Skirting boards or gib board linings can show a much higher moisture content than the timber framing behind these areas, giving a misleading indication. When scanning for moisture the inspector is trained and experienced in looking for other tell-tale signs of moisture ingress.

## PROTIMETER SurveyMaster BLD5365

The world's original and best-selling dual-function moisture meter with pin and non-invasive capabilities.

FOR USE WITH:

- Wood
  - Drywall
  - Building Materials
  - Concrete
  - Fiberglass Boat Hulls
- 
- Built-in pin probes
  - Non-invasive moisture detection up to 3/4" (19mm) below the surface
  - Simple to use 2-button operation
  - Easy to read LED and LCD Display
  - Complete with nylon carry pouch, remote pin probe, deep wall probes
  - Calibration check device included to quickly check functionality



## TROTEC T660 MOISTURE METER

A professional hand-held measuring device for non-destructive determination of moisture distribution in areas up to a depth of 4 cm from the surface.

Over the past decade, the T660 became one of the most commonly used non destructive moisture meters in New Zealand and was trusted by industry building inspection professionals as well as home owners, real estate agents, insurance assessors etc.

Utilising capacitance method, up to 40mm from the surface. Where moisture is located, the readings from the meter, which are displayed on the LCD, increase significantly. (Note: Metal also increases the readings of capacitance meters)

The T660 features a user settable alarm which will alert the user to high readings.

### MEASURING PRINCIPLE

The measuring is effected according to the dielectric measuring principle.

- The measurement results are only to be used as a reference for a rough orientation.
- An important variable influencing the measured value is the bulk density of the good to be measured. The higher the bulk density, the higher the measured value.
- Before measuring, the measuring point is to be cleared of any impurities (e.g. paint residues, dust).
- If the material to be measured contains metal (e.g. nails, screws, lines pipes, etc.) and is situated within the sensor's measuring field, the measured value skyrockets. In that event the measurement is not conclusive.
- When the ball head is held to corners (e.g. Window frames) the measured value is generally higher, Because there is more matter in the measuring head's stray field. Toward a corner a distance of more than 8 to 10 cm has to be observed.
- During the measurement always hold the measuring head in a vertical position to the measured material, press it to the surface and do not tilt it.
- Rough surfaces will always result in a too low measured value.
- Depending on the material's bulk density the device's impact depth amounts to 20 - 40mm. Conclusions regarding zones located at a lower level cannot be drawn.
- With material thickness of less than 20mm there is a danger of humidity values from adjacent material layers affecting the measured value.
- The dielectric measurement method's main area of use consists in comparative measurements at the same construction material or similar components.

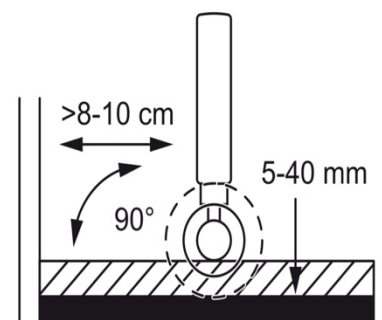

## GENERAL ROOF MAINTENANCE

### THE KEY THINGS YOU NEED TO CHECK NO MATTER WHAT TYPE OF ROOF YOU HAVE.

**The most common type of roofing used in new New Zealand houses is galvanised or coated steel, followed by coated metal and concrete tiles.**

Some maintenance tasks are common to all types of roof, others are specific to the particular roof type. Some tasks will need to be completed more often if you live close to the sea or in a geothermal area. Check with the manufacturer of your roof for specific maintenance requirements.

Flashings may not last as long as the roof so they will require more maintenance. Anything that penetrates the roof, such as pipes, flues or fixings, needs special care to ensure weathertightness.

If you are not sure about roofing work or you are uncomfortable working at heights, consider using a roofing professional. Make sure your roofing professional passes on their own and the manufacturer's warranty.

If you are painting a roof, trimming trees, cleaning guttering, replacing spouting, roofing, repairing chimneys and there are power lines nearby, arrange with your power company to disconnect the supply before carrying out the work.

### ANNUAL MAINTENANCE CHECKS

Once a year you should check your roof cladding, chimneys and flashings by getting up on to the roof. This means using a ladder. Use your ladder safely. Do not work on a wet roof.

Falling and slipping accidents are relatively common when people climb on to a roof to carry out maintenance such as painting or cleaning gutters. On a roof, particularly over 15 degrees in pitch, you generally have little or no chance of catching yourself before the edge if you slip.

Sections of roof that can't be reached by roof ladder – such as parts of a hipped roof or over dormer windows – need a secure way of fixing safety ropes.

Check that the roof can be safely walked on. Some roof materials cannot support the weight of a human (translucent sheet or severely rusted galvanised steel). Old asbestos roofs and clay and concrete tiles can be damaged when walked on so wear soft soled shoes with good grip.

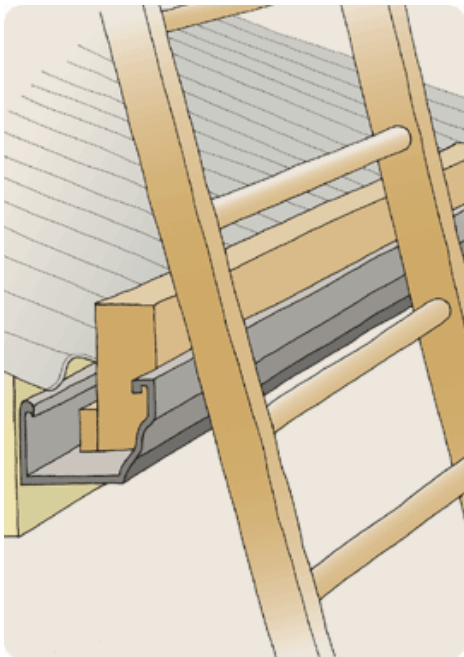

#### When working on a roof:

- Ensure the roof is dry – do not climb on to a wet or damp roof as they can be very slippery.
- Walk along the nail lines.
- On roofs over 15 degrees, slope use a roof ladder.
- If possible use an extended window cleaning brush to clean wall cladding, eaves and joinery from the ground.

#### To avoid damaging the roof and guttering when you are up on the roof:

- Place a timber block in the gutter immediately behind the ladder to prevent crushing the guttering.
- Walk only along the line of nails on steel roofing.
- Step only on the front edge of the tile on tiled roofs – for full inspections use a plank as a walkway. Beware the danger of slipping as angles can be steep.
- Use a cherry picker if there is access around the house for one.

## BUILDUP OF SALTS AND DIRT

This encourages rust on steel roofs, and moss and lichen on tiled roofs. Most manufacturer's warranties require regular washing, particularly in areas that don't get rain washed. Wash the roof down every 3 to 12 months according to the particular product and your location. Consult your manufacturer for specific information.

Concentrate on washing areas that do not get rain washed, such as under the eaves. You may need to wash the roof more often in coastal, geothermal or highly industrial areas to keep salt, sulphur and other deposits to a minimum.

Washing the roof also gives you an opportunity to check the general condition of your roof.

## DAMAGED/UNSTABLE TV AERIAL OR RECEIVER DISH

The aerial could come loose and fall. A damaged aerial may also affect your TV reception.

There are many different makes and models of TV aerials. You are better off getting the advice of a professional rather than trying to repair or replace an aerial yourself. Although you can replace bent or corroded elements, it is probably only going to be a short-term measure.

## CRUMBLING CHIMNEY MORTAR

Crumbling mortar could be due to moisture getting in. The mortar will need re-pointing and this is a job for the professionals. If the chimney pot is badly damaged you may want to consider replacing it with a metal cowl. If the chimney is no longer used, block off the top to stop birds, rain and draughts.

## CORROSION OF FLUE PIPE, COWL OR FASTENINGS

This could be due to a build up of combustion deposits. Clean the flue, and the roof around it, regularly during the heating season to keep combustion deposits to a minimum. Fires can occur in flues or chimneys that haven't been cleaned. For existing corrosion, remove the rust and then paint with a zinc-rich primer. Prime with galvanised iron primer and apply roof paint. Replace severely damaged fastenings with hot dipped galvanised or stainless steel fastenings as appropriate to reduce corrosion in future. Use a chimney sweep.

## INSECURE METAL FLUE

This could be due to corrosion of the fixings, especially in areas near the sea.

If the fixings have corroded, replace them with hot dipped galvanised ones. This will only be a temporary solution – you will eventually need to replace the nails, especially if you live close to the sea. Replace or re-fix others, increasing the number if necessary.

## CORRODED GALVANISED METAL FLASHINGS

Corrosion is common in areas near the sea but can also occur in other areas. Flashings protect vulnerable areas of the roof. If they fail, they can affect the weathertightness of the roof allowing water to get into your home.

Remove the corrosion and paint with zinc-rich primer, metal primer and finish coat. If the corrosion is severe, replace the flashing.

## LIFTED OR DISLODGED FLASHINGS

Flashings protect vulnerable areas of the roof. If they fail they can affect the weathertightness of the roof allowing water to get into your home.

Replace loose nails with new nails or screws and increase the number if necessary. Make sure there is timber below to fix the nails in to.

## PONDING WATER

Water ponds when there is insufficient slope on the roof or the roof is sagging. The ponding water will cause the roof to deteriorate. This is most common on flat or membrane roofs.

Before addressing the cause, check if the roof structure is still under warranty. By making changes to the structure of the roof, you may invalidate the warranty. You may also need a building consent.

Consult with a professional if you need to make changes to the structure of the roof to address ponding.

## TREES

Trees can cause many problems for roofs of all types. Overhanging branches can scratch and gouge roofing materials when blown by the wind; falling branches can damage or puncture shingles and other roofing materials; and falling leaves can clog gutters causing water to backup or run down behind the fascia.

Trees that are adjacent to the house should be kept well trimmed. Keep your gutters clear of leaves and debris. Consider using a product to prevent leaves lodging in guttering.

# MAINTENANCE

Although many building materials and systems today are sold as “low maintenance”, most still require some type of maintenance to remain durable and perform well, even if this is just an occasional cleaning. Many wall cladding systems, for example, have specific maintenance requirements so ensure they remain watertight over the long term. Maintenance may be required for the warranty to remain valid.

Although the responsibility for carrying out this maintenance rests with the homeowner, contractors must explain to homeowners what work is required ( see information handover above) and the potential consequences of not carrying it out. Building practitioners can benefit from houses being well maintained because this may result in fewer call backs and their work their work performing well and looking good for a much longer period of time.

## GENERAL AREAS OF EXTERIOR MAINTENANCE ARE:

- Cleaning roof gutters
- Inspecting window and door flashings and glass seals
- Inspecting and replacing sealants
- Inspecting roof flashings/membranes/claddings
- Cleaning and re-coating roof finishes
- inspecting construction gaps and keeping them clear
- Cleaning and re-coating wall claddings
- Keeping ventilation clear under suspended floors

## GOOD MAINTENANCE IS CRITICAL WITH CERTAIN MATERIALS OR SYSTEMS INCLUDING:

**Face seal coatings on some cladding systems.** These must be regularly cleaned and re-coated for weathertight performance critical sealant joints on some cladding systems.

**Exposed Sealant Joints** are fundamental in stopping water penetrating critical junctions critical flashings, such as window head flashings, which ensure that water is deflected over a penetration in the cladding.

## HOMEOWNERS SHOULD KEEP AN EYE OUT FOR INDICATIONS OF PROBLEMS THAT REQUIRE IMMEDIATE ACTION, INCLUDING:

- Gaps around canter-levered deck joists or other cladding penetrations
- Gaps in junctions between different materials or building features
- Sealant that has come loose
- Cracks, splits or open joints in cladding
- Metal corrosion
- Gaps around window seals or sashes
- Loose-fitting cover boards, scribes or plugs
- Joints or mitres that have opened or where the paint has cracked
- Gaps at the end of flashings
- Water ponding on a roof or membrane deck surface
- Rotten timber
- Mould on interior walls or ceilings
- Cupped or buckled weatherboards
- Stand or dark patches on walls
- Raised flashings
- Gaps appearing between the skirting and the wall
- Missing roof fixings or holes in the roof
- Swollen skirting timber and window or door reveals
- Overflowing spouting
- Damp or rotten carpet

# ASBESTOS

There is a one-stop shop for homeowners who need to know more about asbestos containing materials [www.asbestosaware.co.nz](http://www.asbestosaware.co.nz). While this information was initially developed for people living in the Greater Christchurch area, its relevant for anyone undertaking or commissioning residential work that may involve disturbing asbestos or asbestos containing materials.

## WHERE DOES ASBESTOS HIDE?

Asbestos containing products can be found in lots of places, as the image below shows. You might find it in vinyl flooring, interior and exterior wall cladding and soffits, fences, texture coatings, fireplaces, stoves, hot water cupboards, electrical switchboards, roofs, guttering and downpipes. The list goes on.

Buildings constructed before 1990 (and some up to 2000) are likely to contain asbestos materials. The diagram shows areas where materials containing asbestos were commonly use during construction. These materials are not dangerous if they are in a good condition and remain undisturbed.

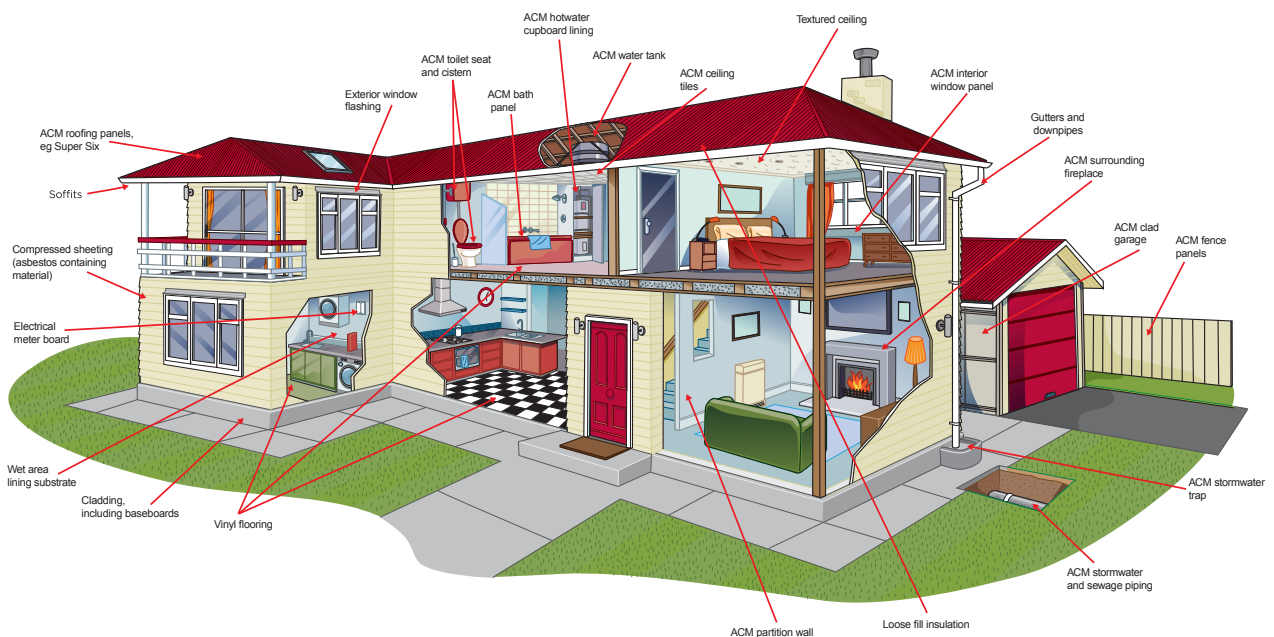

For further information visit:

[www.worksafe.govt.nz/topic-and-industry/asbestos/information-for-homeowners/](http://www.worksafe.govt.nz/topic-and-industry/asbestos/information-for-homeowners/)

[www.asbestosaware.co.nz](http://www.asbestosaware.co.nz)

# CARING FOR YOUR JOINERY.

**Maintain your aluminium windows and doors by washing them regularly. Remember aluminium joinery is low maintenance, not no maintenance.**

## WHAT TO USE?

Use a mild soap, warm water and a quality liquid is always handy and works well. Simply wash the entire frame with soapy water, rinse with clean water and dry to avoid streaking.

## POINTS TO NOTE

Proper drainage is important to extend the lifetime of your windows and doors.

Remove any debris clogging drain holes. And ensure sliding door tracks are clean and free from debris.

Reduce condensation by removing or limiting moisture sources and improving ventilation. Excessive moisture can reduce performance and cause permanent damage.

## WHAT NOT TO USE?

Never use solvent cleaners as they can damage the powdercoating on your windows and doors. Common solvents like petrol, acetates, thinners and Methyl Ethyl Ketone (MEK) are very damaging, including Jif.

Highly acidic, alkali and many common household solvent or alcohol-based cleaners are also not recommended.

## HOW OFTEN

- Coastal - clean every 3 months
- Geothermal - clean every 3 months
- Industrial - clean every 3 months
- Rural - clean twice a year
- Residential - clean twice a year

## PAINT SPLASHES, SEALANTS, CONCRETE AND MORTAR

After first testing a non-visible area, remove paint or sealant splashes with a cloth soaked in methylated spirits. Spirit must be washed off immediately with soapy water after use

During construction concrete and mortar splashes can damage your joinery.

## SUNSCREENS

It is important to note that sunscreens containing Zinc or Titanium oxides, will damage the powdercoat surface of your joinery over time.

It is recommended that joinery which has come into contact with sunscreens, either during construction or in general, is cleaned with soapy water and then rinsed clean immediately.

## FURTHER TIPS

Opening louvre windows to different angles will allow the sun to make contact evenly across the surface to assist with uniform colouration and drying.

# CARING FOR YOUR HARDWARE AND ENTRY DOOR.

**Maintain your hardware, components and entry door with proper use and regular cleaning. Help your windows and doors keep working for longer.**

## WHAT TO USE?

Wash your hardware every month with a mild cleaner like dishwashing liquid mixed with warm water. Adjust and lubricate your hardware as directed by your supplier.

- Clean hinges and window stays at the same time as your aluminium joinery, with a mild cleaner.
- Door closers should be checked and maintained. If doors are slamming shut, adjust or consult your supplier.
- Check for and replace all damaged components of your window and door system. This includes seals, gaskets, rubbers and rollers. Damaged components can reduce lifetime considerably.
- Entry door - look after as stated above; and clean panels and other surfaces by following the same guidance as for your windows and doors.
- Split hinges should be replaced. Wedging doors open can cause permanent damage.
- Timber panels (and louvres):
- Timber should be sealed around all 6 sides to ensure optimal performance and longevity - talk to your local fabricator for more information. For care and maintenance of your timber doors, please refer to your timber door supplier.

## WHAT NOT TO USE?

Avoid washing with household cleaning sprays as they can be too aggressive and cause damage. Do not oil keyholes of locks. Do not slam covering new entry doors.

## HOW OFTEN?

- Coastal - clean every month
- Geothermal - clean every month
- Industrial - clean every month
- Rural - clean every month
- Residential - clean every month