

**Slotting  
and  
Parting**

# Slitting Cutter

**New**

## Features

- Optimal chip breaker design and N/L edge treatment make to increase cutting edge rigidity.
- Exact position of V-groove part enables to powerful clamping.
- Secure clamping system guarantees smooth cutting force with the positive geometry.
- Main application for slotting and parting off machining.

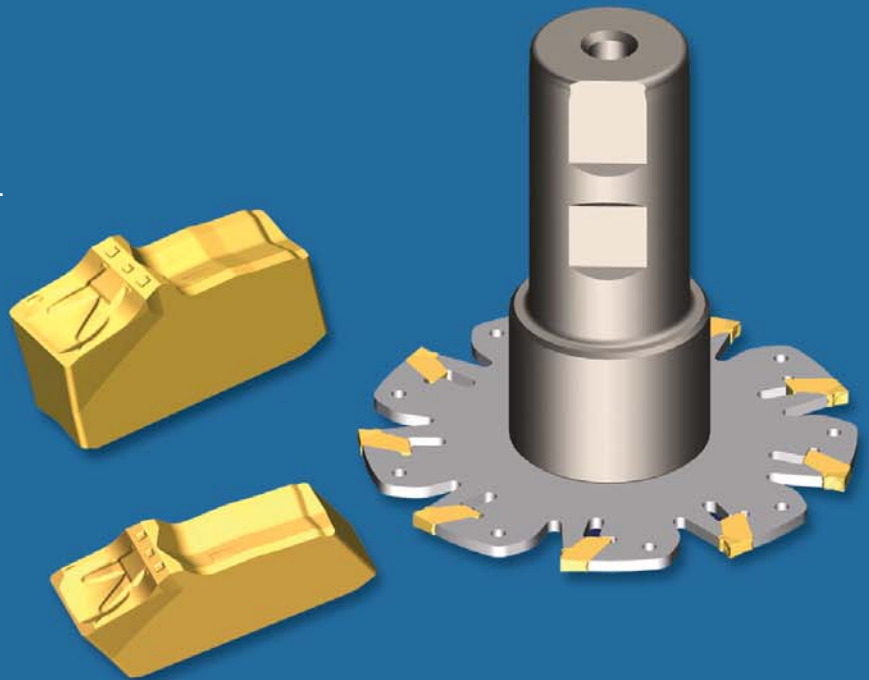

# Slitting cutter

Clamping system | Chip control | insert | Code system

## Clamping system

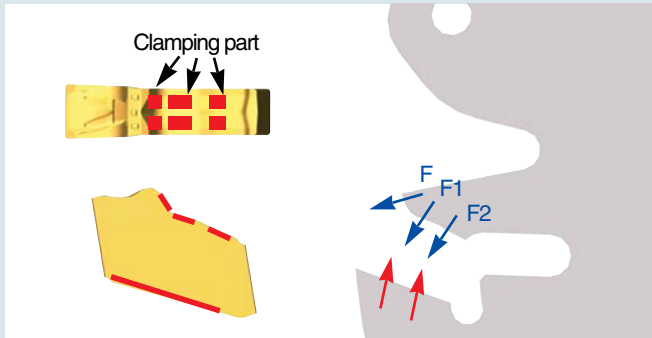

## Chip control

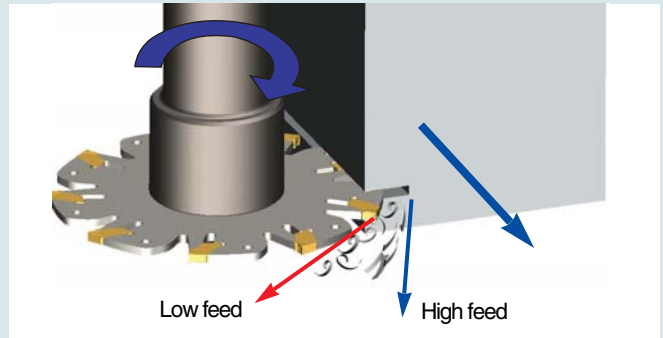

## The assembly of insert

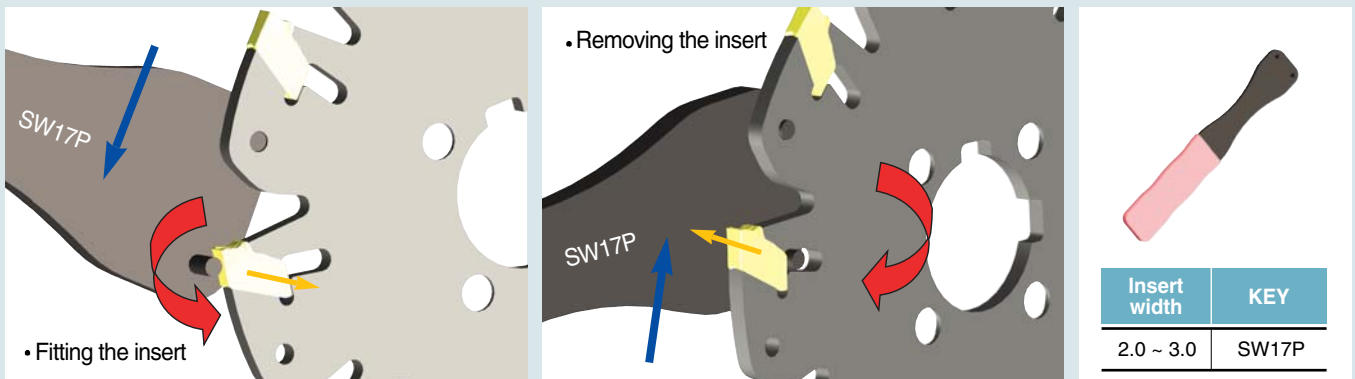

## Slitting cutter code system

SP	S	100	-	03	
Using SP Insert	Slitting cutter Side cutter	Cutter diameter(ø)		Insert width	

  

09	-	22	R
Number of tooth		Arbor size(ø)	- R : Weldon Shank type - F : Drive Flange type - R / F : Interchangeably (WS type/ DF type)

# Slitting cutter

SPS | WS( )-( ) | DF( )-( )

## SPS

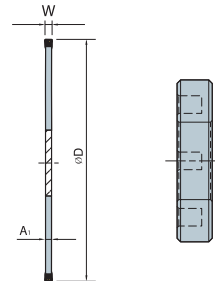
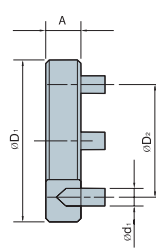
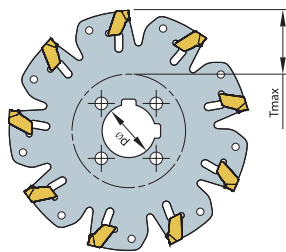
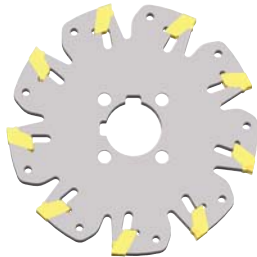

Desingation	Stock		Dimensions(mm)									T max	Adaptor		Inserts
	R	L	øD	øD <sub>1</sub>	øD <sub>2</sub>	ød	ød <sub>1</sub>	W	A	A <sub>i</sub>	Tooth		WS	DF	
SPS050-0204-08R	○		50	28	18	8	-	2.2	-	1.8	4	11	✓	-	SPFN 200 - ( )
SPS063-0205-10R	○		63	32	22	10	-		-		5	15.5	✓	-	
SPS080-0207-22R/F	○		80	46	32	22	5		10		7	17	✓	✓	
SPS100-0209-22R/F	○		100	46	32	22	5		10		9	27	✓	✓	
SPS125-0211-32F	○		125	55	45	32	6		10		11	35	-	✓	
SPS160-0214-32F	○		160	55	45	32	6		10		14	52.5	-	✓	
SPS063-0305-10R	○		63	32	22	10	-	3.0	-	2.55	5	15.5	✓	-	SPFN 300 - ( )
SPS080-0307-22R/F	○		80	46	32	22	5		10		7	17	✓	✓	
SPS100-0309-22R/F	○		100	46	32	22	5		10		9	27	✓	✓	
SPS125-0311-32F	○		125	55	45	32	6		10		11	35	-	✓	
SPS160-0314-32F	○		160	55	45	32	6		10		14	52.5	-	✓	
SPS200-0318-40F	○		200	80	63	40	11		12		18	60	-	✓	

● Stock item, ○ Under preparing for stock

## ■ WS( )-( ) (Weldon Shank type)

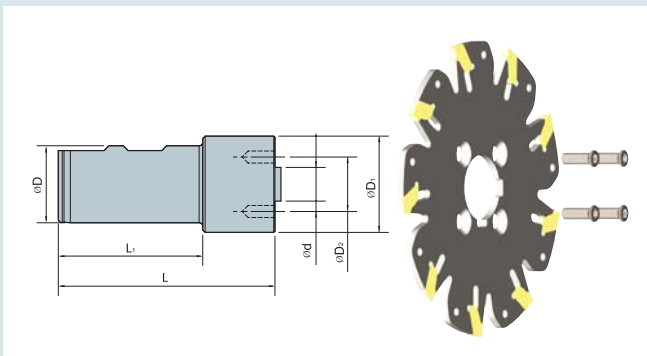

Desingation	Stock		Dimensions(mm)						Screw
	R	L	L	L <sub>i</sub>	D	D <sub>1</sub>	D <sub>2</sub>	d	
WS2528-M5	○		110	85	25	28	18	8	PTKA 0515
WS2532-M5	○		110	85	25	32	22	10	
WS3240-M5	○		120	90	32	40	32	22	

## ■ DF( )-( ) (Drive Flange set)

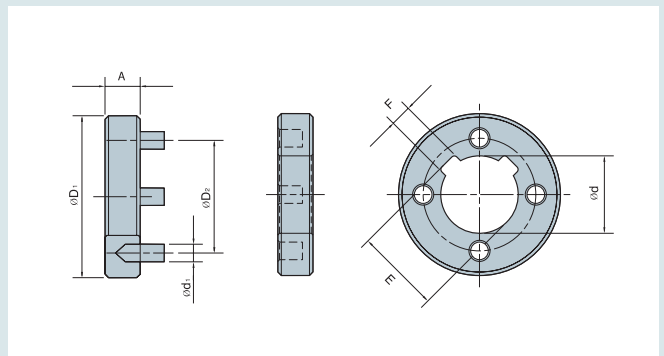

Desingation	Stock		Dimensions(mm)						
	R	L	D <sub>1</sub>	D <sub>2</sub>	d	d <sub>1</sub>	A	E	F
DF22-46	○		46	32	22	5	10	24.1	6
DF32-55	○		55	45	32	6	10	34.8	8
DF40-80	○		80	63	40	11	12	43.5	10
DF50-110	○		110	80	50	14	14	53.6	12

● Stock item, ○ Under preparing for stock

# Slitting cutter

SPFN insert | Recommended cutting condition | Cutting depth

## SPFN insert

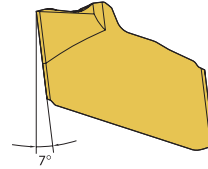
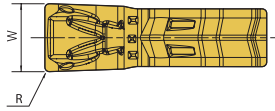
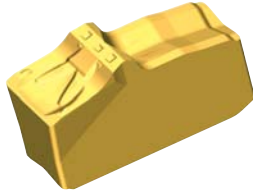

Desingation	Dimensions(mm)		Grade						
			PVD				CVD		Uncoated
	W	R	PC3525	PC3535	PC9530	PC215K	NCM325	NCM335	ST30A
SPFN200-N	2.2	0.2	○	○	○	○	○	○	○
SPFN300-N	3.0	0.2	○	○	○	○	○	○	○

● Stock item, ○ Under preparing for stock

## Recommended cutting condition

※ T/D = 10%(T:cutting depth)

Workpiece		Hardness	Grade	vc(m/min)	fz(mm/t)
P	Low carbon steel / Alloy steel	≤ 180HB	PC3525	210 (170 ~ 250)	0.13 ~ 0.30
	High carbon steel / Alloy steel	180 ~ 260HB	PC3525	150 (100 ~ 200)	0.13 ~ 0.25
	High alloy steel	260 ~ 350HB	PC3525	120 (80 ~ 170)	0.10 ~ 0.17
M	Stainless steel	150 ~ 300HB	PC9530	160 (120 ~ 200)	0.10 ~ 0.22
K	Cast iron	T/S ≤ 350N/mm <sup>2</sup>	PC215K	110 (70 ~ 150)	0.10 ~ 0.25

## Correction factor of fz(mm/t) as cutting depth

Machining	T/D (%)	Factor	fz (mm/t)	
	50 ~ 100	Standard = 1.0	0.07	0.15
	2.5	3.7	0.26	0.56
	5	2.5	0.18	0.38
	10	1.8	0.13	0.27
	15	1.5	0.11	0.23
	20	1.3	0.09	0.20
	25	1.2	0.08	0.18

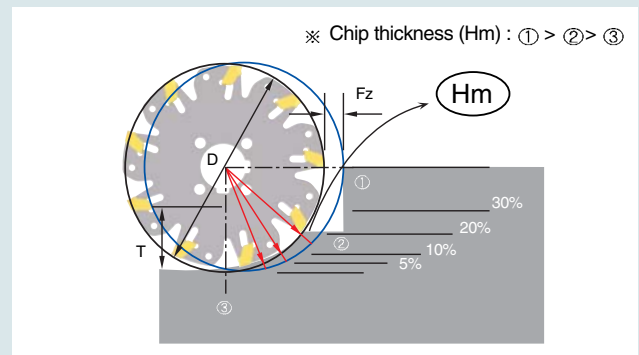

• Correction factor by T/D(%) : The value of chip thickness rate as feed (fz)