

LEDnova

Robust and highly reliable LED bulkhead range



LEDnova



IP 66

Up to
IK 10



Up to
20kV



LEDnova-mini
(Painted version)



LEDnova-midi
(Painted version)

A robust and versatile LED bulkhead

The LEDnova offers optimal photometric performance and high reliability to reduce energy consumption and maintenance in all types of lighting applications.

The LEDnova range is suitable for use in various environments, which include outdoor mining areas, oil and gas refineries, food and beverage plants, manufacturing process plants and any application that requires robust and well-built luminaires. Indeed, the LEDnova range has been developed to reduce disability glare and thus improve the quality of light.

A number of configurations are possible with this LED bulkhead, which include the standard surface mount version, the optional pole mount version, and the flood version. This makes it truly versatile!

The LEDnova range can also be used in hazardous environments where a Zone 2, 21/22 rated luminaire is required. It is also available with a battery backup version, to be used in emergency situations.

Key advantages

- Designed and manufactured in South Africa
- Designed to operate LED light sources of up to 81W without reducing the useful lifetime of up to 100 000 hours, at a lumen depreciation of not more than 10% (L90)
- Ta of up to 45°C (Not applicable to all configurations)
- Slim, aesthetical design optimised for LED characteristics
- Designed to replace conventional HID and CFL bulkhead luminaires
- Easy to install
- Surge protection 10kV/10kA
- 5 year warranty (Terms and conditions apply)



HAULAGE
LIGHTING



INDUSTRIAL
HALLS &
WAREHOUSES



INDUSTRIAL
HARBOUR



RECLAIMER



CONVEYOR
BELT



WAREHOUSE

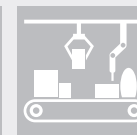

ASSEMBLY LINE



LOADING BAY

Characteristics

GENERAL INFORMATION

Recommended installation height	Up to 8m
FutureProof	Easy replacement of the photometric engine and electronic assembly on-site
Driver included	Yes
ROHS compliant	Yes
Testing standard	SANS 60598, SANS 62262

HOUSING AND FINISH

Housing	Marine grade high-pressure die-cast aluminium (EN 1706 AC-44300)
Optic	Acrylic PMMA
Protector	Glass High-impact polycarbonate (optional)
Housing finish	Unpainted aluminium
Tightness level	IP 66
Impact resistance	Glass: IK 07 High-impact polycarbonate: IK 10
Access for maintenance	Easy access to the gear compartment

DIMENSIONS AND MOUNTING

AxBxC (mm)	Mini: 460x249x63 Midi: 462x283x83
Weight (kg)	Mini: 3.8 Midi: 4.8

ELECTRICAL INFORMATION

Electrical class	EU class I or II
Nominal voltage	198-264V – 50Hz
Power factor	> 95% at full load
Surge protection	10kV / 10kA 20kV / 20kA (optional for Midi only)
Electromagnetic compatibility (EMC)	SANS 55015:2013/A1:2015, SANS 61000-3-2:2014, SANS 61000-3-3:2013, SANS 61547:2009, SANS 62493:2015

OPTICAL INFORMATION

LED colour temperature	4000K (Neutral white)
Colour rendering index (CRI)	≥ 70
Standard optic	5068

OPERATING CONDITIONS

Operating temperature range (Ta)	-35°C up to +45°C (*) (Not applicable to all configurations)
----------------------------------	---

(*) Depending on the luminaire fixation and driving current. For more details, please contact us.

LIFETIME OF THE LEDS @ TQ 25°C

For all versions	100,000h - L90B10
------------------	-------------------

LIFETIME OF THE DRIVER @ TQ 25°C

For all versions	100,000h ≤10% failure rate
------------------	----------------------------

For options and accessories, please turn to page 7.

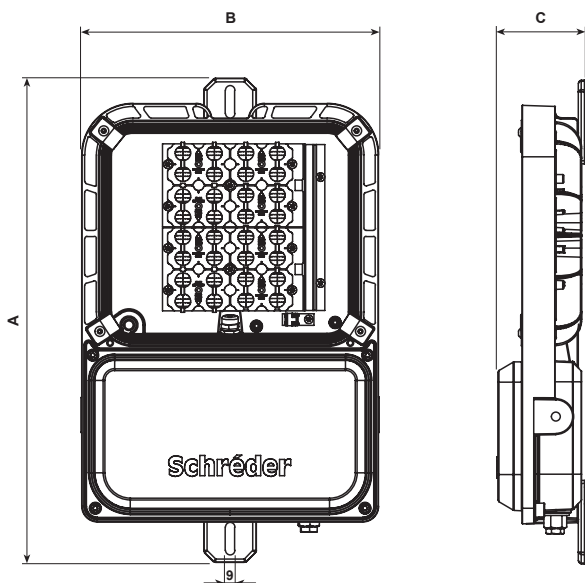

Performance



				Nominal flux (lm) ^(*)	Power consumption (W)	Nominal efficacy (lm/W)	Luminaire output flux (lm)	Luminaire efficacy (lm/W)	Photometry
Luminaire	Number of LEDs	Current (mA)	Line Current (A)	Typical	Typical	Typical	Typical	Typical	
Mini	8	700	0.09	2631	20	132	2184	109	
	8	1000	0.13	3498	29	121	2903	100	
	16	700	0.16	5157	37	140	4280	116	
	16	1000	0.24	6995	55	128	5806	106	
	24	700	0.24	7676	54	143	6371	118	
Midi	24	700	0.24	7676	54	143	6371	118	
	24	1000	0.36	10493	81	130	8709	108	
	32	700	0.31	10235	70	147	8495	121	
Midi (Emergency version)	16	700	0.16	5157/745 (EM)	37	140	4280	116	
	16	1000	0.24	6995/745 (EM)	55	128	5806	106	
	24	1000	0.36	10493/745 (EM)	81	130	8709	108	
	32	700	0.31	10235/745 (EM)	70	147	8495	121	

Tolerance on LED flux is $\pm 7\%$ and on total luminaire power $\pm 5\%$

(*) The nominal flux is an indicative LED flux @ Tj 25°C based on LED manufacturer's data. The real flux output of the luminaire depends on environmental conditions (e.g. temperature and pollution) and the optical efficiency of luminaire. The type of LED used is subject to change due to the ongoing rapid progress taking place in LED technology.

Construction Details

The LEDnova's slim and unique design is optimising the thermal operating environment around the LEDs enabling the long useful lifetime (100 000hrs, L90) and low maintenance.

The luminaire housing is manufactured of corrosion-resistant marine grade high-pressure die-cast aluminium (EN 1706 AC-44300).

Electronic temperature monitoring prevents overheating of LEDs and power supply within the LED compartment (ThermiX®). To maximize the reliability of the LEDs, the photometric engine and control gear compartment are completely sealed to IP 66. This ensures that the photometric performance is maintained over time.

The LEDnova offers flexible combinations of LED arrays, combined with various photometric distributions (LensoFlex®2) and dimming control options to further maximise energy savings and reduce maintenance costs.

It is designed for LED light sources between 20W and 81W.

The luminaire is power factor corrected to $\geq 0,95$.

Key Features

Corrosion-resistant marine grade high-pressure die-cast aluminium housing (EN 1706 AC-44300)

Surge protection 10kV/10kA
Optional: 20kV/20kA (Midi only)



ThermiX®: Maintains performance over time

Optimised lighting through LensoFlex®2

FutureProof: Direct access to photometric engine and electronic assembly in case of upgrading or replacing components



Versatile stirrup mounting



Integrated vent (breather) for rapid pressure equalisation and reduction of condensation



LEDnova-midi: Available for Emergency and Zoned applications

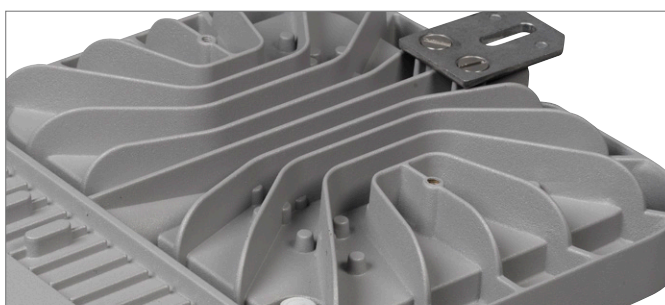

Unique thermal design concept

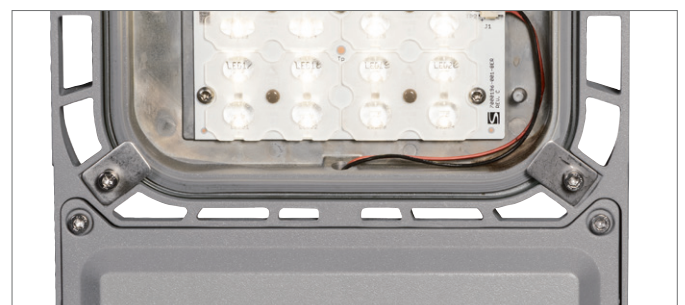

LEDnova-mini: Thermal separation between gear and optical compartment, ensuring optimum performance

Light Distributions

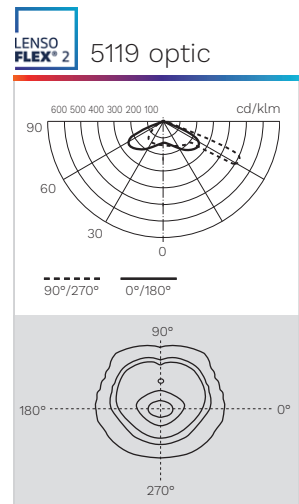
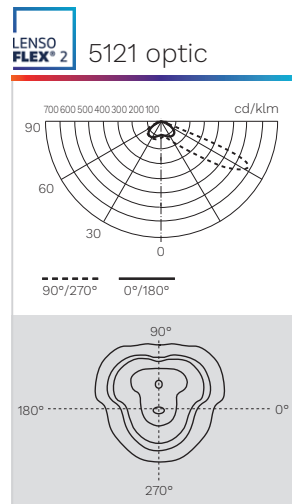
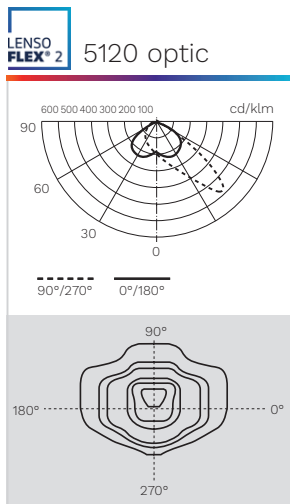
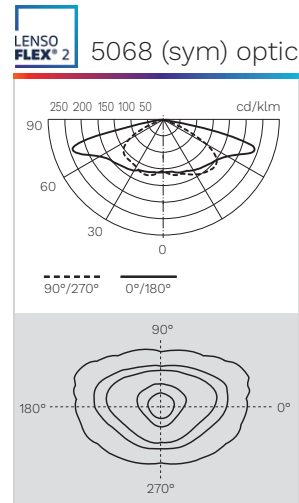
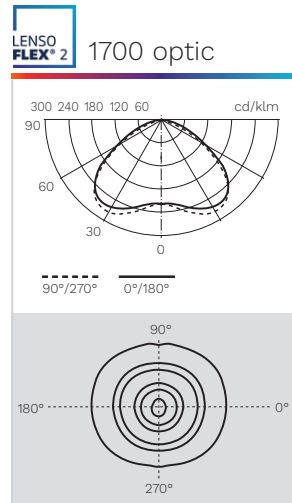
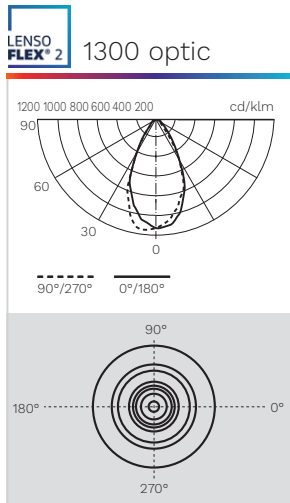

Integrated Movement Sensor (optional)

The integrated motion sensor uses a specific lens to determine a detection zone. The standard lens is suitable for most applications. As an option, lenses can be provided for special needs.

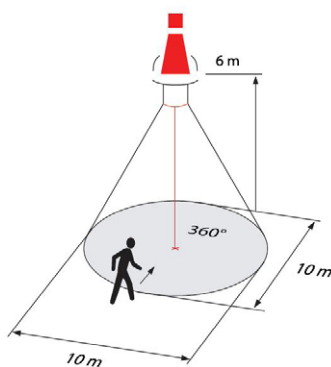

Mounting Options

LEDnova-mini & LEDnova-midi

Wall/Ceiling mounting (standard)

Stirrup mounting (optional)

Pole mounting (optional)

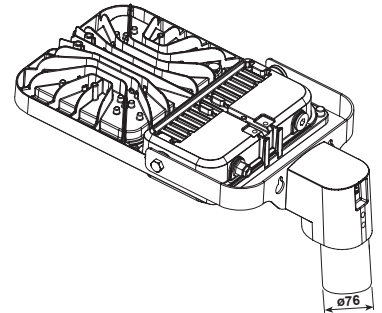
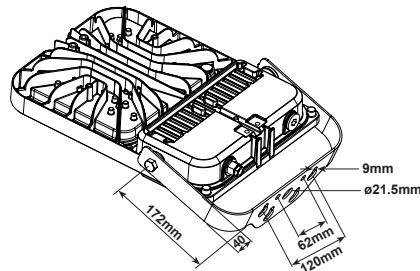
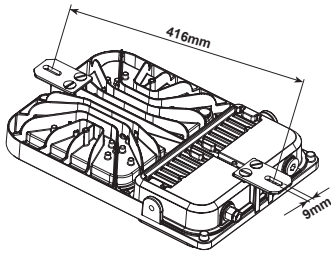

Ordering Information

Example:

LEDnova-md3270N5068A1GWmdE1DUIV

ID	LED	Watt	LED Colour	Optic	Colour options	Surge Protection	Protector	Mounting	Other options
LEDnova-mi	8	20	N	1100	A	1	G	md	Z21
	8	29	Neutral	1200	Aluminium finish	10kV	Glass clear (IK08)	Mounting lugs (facing down)	Zone 21/22
	16	37	White (4000K)	1300	(unpainted)		P	mv	
	16	55		1700			Polycarbonate (IK10)	Mounting lugs (wall vertical)	
LEDnova-md	24	54		5068 (sym)	L				
				5119	Pearl Light Grey (RAL 9022),				
				5120	Textured finish		G	p	Z2⁽¹⁾
				5121			Glass - gasket version (IK07)	Pole mounted	Zone 2
	16	37			O		P	sh	Z21
	16	55			Painted Other (RAL / Finish [Brilliant/Matt])		Polycarbonate (IK10)	Stirrup mounted hot dipped galvanised	Zone 21/22
	24	54				S	ss	E1	Emergency version (1 hour)
	24	81				Glass - silicone version (IK07)	Stirrup mounted stainless steel (Midi only)	DL	Downward facing daylight switch
	32	70				Glass (gasket) & wire guard	o	UIV	90-305V - 50Hz
						PW	Other (no mounting components supplied)		
						Polycarbonate & wire guard			
						SW			
						Glass (silicone) & wire guard			

⁽¹⁾ Not available for LEDnova-midi EM 16 LED/1000mA version

Custom Options

	Integrated movement sensor up to 12m (LEDnova-midi only)
Switching/dimming control	DALI
	1-10V
	Optidim
Electrical class	EU Class II
Surge protection	20kV (LEDnova-midi only)
Emergency	3 hours - external gearbox (LEDnova-midi only)
Correlated colour temperature	3000K
	5700K
Extra treatment	e-Coating (for very harsh environments)

BEKA Schröder

Experts in lightability™

SABS
ISO 9001



www.beka-schreder.co.za

Designed and manufactured by BEKA Schröder (Pty) Ltd



2019-11

Copyright © BEKA Schröder (Pty) Ltd 2019 – 13 West View Road – Olifantsfontein (South Africa) • The information, descriptions and illustrations herein are of only an indicative nature. Due to advanced developments, we may be required to alter the characteristics of our products without notice. As these may present different characteristics according to the requirements of individual countries, we invite you to consult us.