

MP / LP Chip Breaker

MP (Negative)
For medium cutting

MP (Positive)
For medium cutting



LP (Negative)
For medium to finish cutting

Turning Insert for Machining Automobile Components

Complete turning solution to increase productivity at a wide range of cutting speed, feed and depth of cut.

- ▣ **Universal Chip Control**
Increased productivity with stable chip control in various machining
- ▣ **Stable Tool Life**
Reduced cutting force brings stable tool life at high speed and high feed

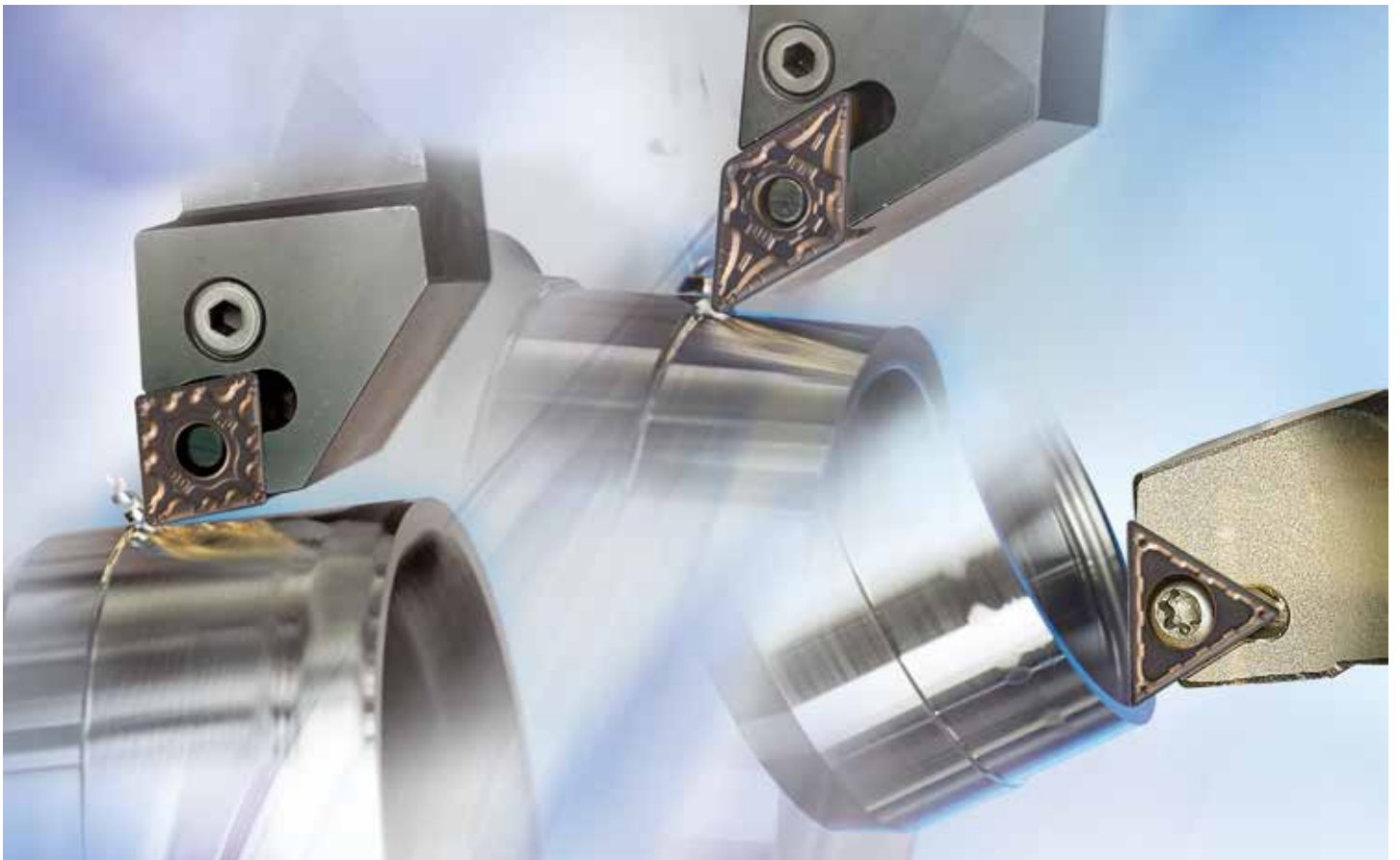

High Performance CVD Coated Turning Inserts For Machining Forged and Bearing Steels



**LP Chip Breaker
(Negative)**

For medium
to finish cutting



**MP Chip Breaker
(Negative)**

For medium
cutting

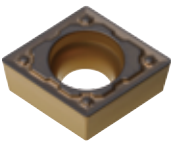

**MP Chip Breaker
(Positive)**

For medium
cutting

The surface of forged steel that is commonly used for automobile parts is hard and tough while the inside is soft. Bearing steels also have the same characteristics of high toughness and hardness. Machining these steels repeatedly causes built-up edge and edge chipping, which are two of the most common causes of reduced productivity and unstable tool life. The demands of mass production of automobile parts requires faster cutting speeds, higher feeds, and much longer tool life than ever before.

Negative LP / MP Chip breakers feature two step dots at the corners and an optimized blade design which bring a measurable increase in productivity, and exhibit excellent chip control, and cutting performance when machining a variety of forged steels at high speeds (max. 350m/min) and high feeds (max. 0.45mm/rev).

Positive MP chip breakers reduce cutting loads due to sharp cutting edges and wide chip pockets when machining outer surfaces of forged steels. Its special three dimensional geometries create smooth chip evacuation even on rough surfaces. In addition, it largely contributes to increased productivity, stable tool life, and excellent surface finish.

NC3215 / NC3225 are new CVD coated grades for turning applications of automobile components, made with forged and bearing steels. NC3225 is the first choice for machining forged parts, while NC3215 is ideal for high speed and continuous machining.

NC3215 / NC3225 in combination with LP / MP chip breakers ensure a precise cutting action and maximum cutting efficiency when machining automobile components.

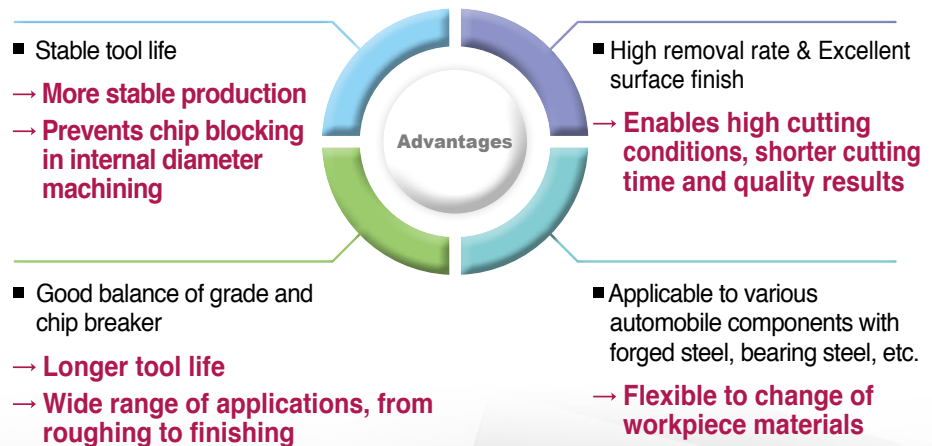

⇒ Common Problems When Machining Forged Steel

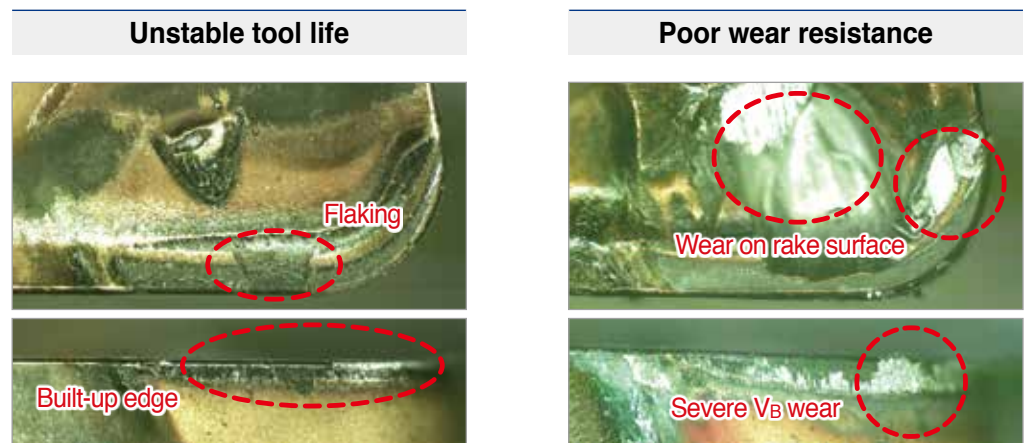

⇒ NC3215 / NC3225 Technology

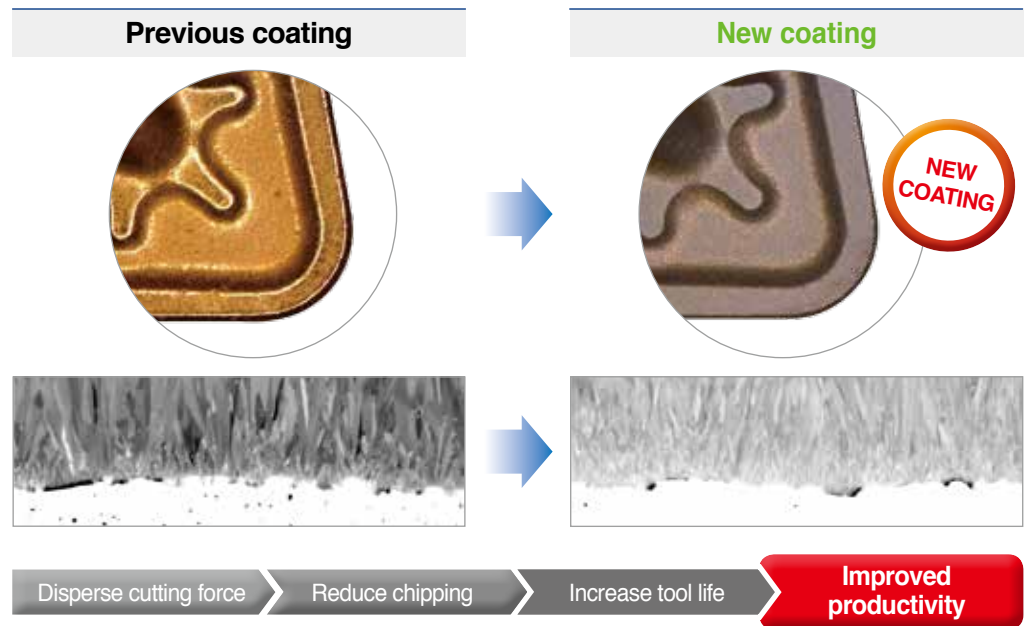

⇒ Troubles Solved with New Technology

NC3225 P25 is the first choice in **turning applications of steel materials**. It can be also used for **hard to cut materials** through post processing, as well as carbon steel, alloy steel, and all other steel materials.



MP / LP Chip Breaker

MP Chip Breaker [Negative (For medium cutting)] P

- Chip breaker for forged steel of automobile parts and general steels.
- Quad dots improve productivity through efficient chip control at high feed.
- Angle land minimizes cutting force.

⇒ Features of MP Chip Breaker

Front two step dot

- Higher stability of chip curls at high feed
- Excellent chip control when copying
- Lower cutting force at high depth of cut

Variable land

- Less crater wear
- Prevents chipping on minor cutting edge.
- Higher toughness at high depth of cut and interrupted cutting

Flat zone

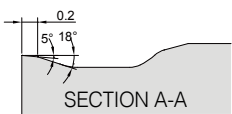

SECTION A-A

- Larger chip pocket for better chip evacuation at high feed
- Reduced cutting force with larger contact surface of chips

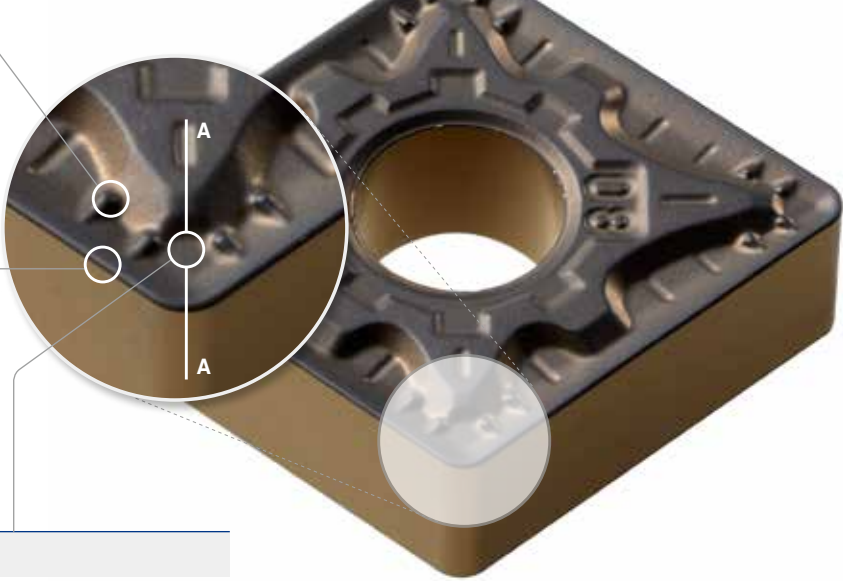

⇒ Cutting Performance (Evaluation of chip map)

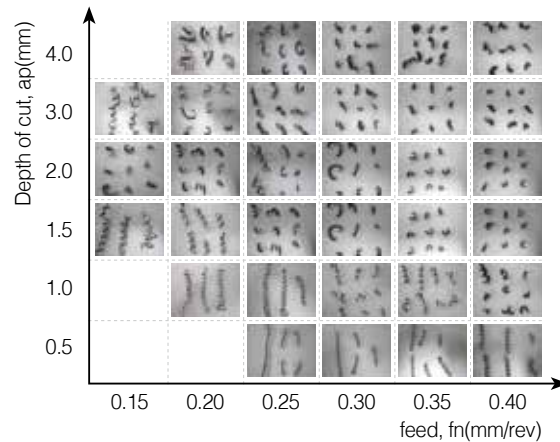

⇒ Application Range (For medium cutting)

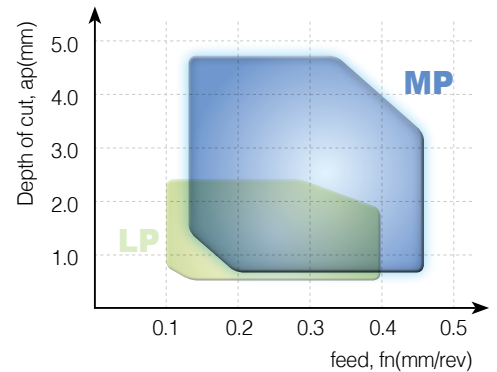

- **Workpiece** C50 (Forged steel), Ø100, External machining
- **Cutting conditions** vc(m/min) = 250, ap(mm) = 0.5~5.0, fn(mm/rev) = 0.1~0.5, wet
- **Tools** CNMG120408-MP

➔ Smooth chip flow and efficient chip control at low feed

➔ Cutting Performance (Evaluation of wear resistance)

- Workpiece 42CrMo4 (Alloy steel), Ø100, External machining
- Cutting conditions $vc(m/min) = 280$, $ap(mm) = 1.5$, $fn(mm/rev) = 0.25 / 0.40$, wet
- Tools CNMG120408-□□

Longer tool life due to lower cutting force at both medium feed(0.25mm/rev) and high feed(0.40mm/rev)

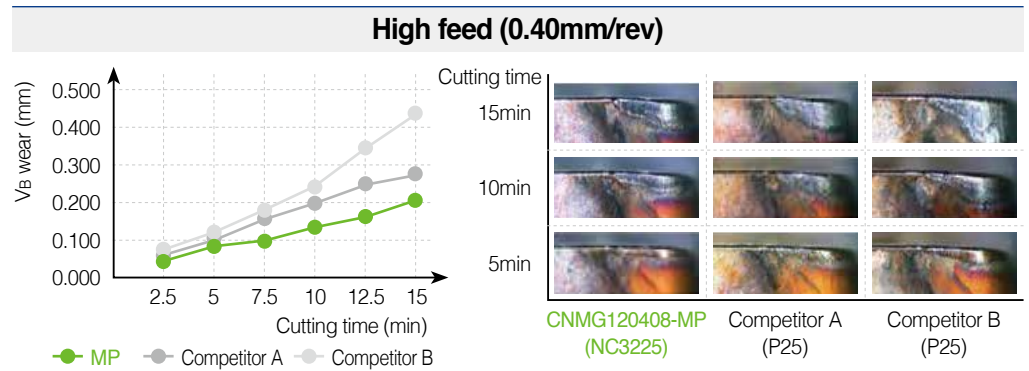
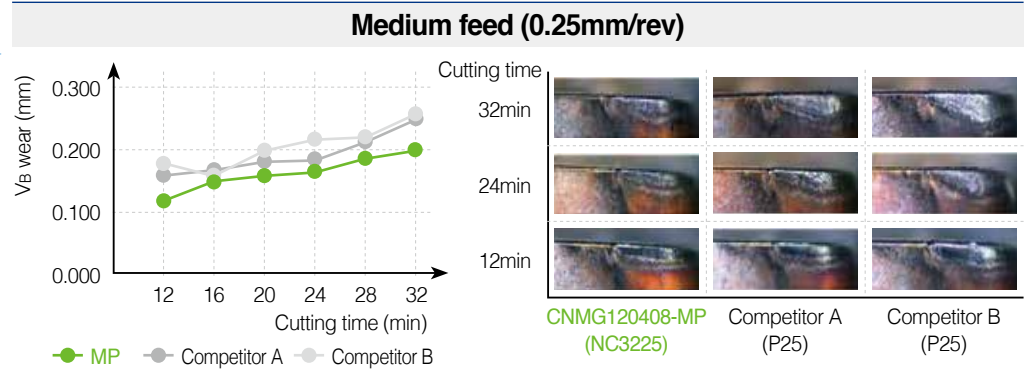

➔ Cutting Performance (Evaluation of toughness)

- Workpiece C45 (Carbon steel), Ø100 (4 Grooves), Facing
- Cutting conditions $vc(m/min) = 250$, $ap(mm) = 1.5$, $fn(mm/rev) = 0.25 / 0.40$, wet
- Tools CNMG120408-□□



- NC3225 has **20% longer tool life** than competitor's(P25).
- MP Chip breaker ensures **stable chip control** and minimum burr for **excellent surface roughness**.

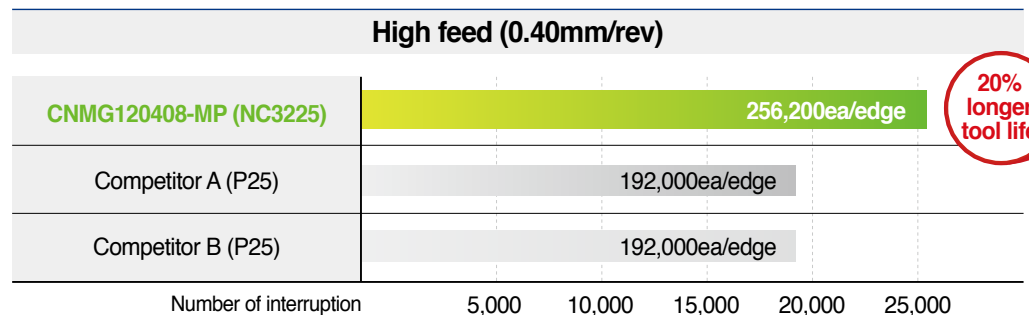
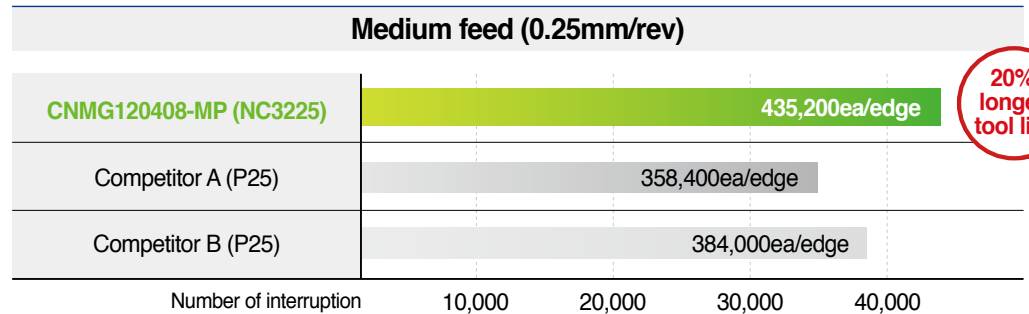

LP Chip Breaker [Negative (For medium to finish cutting)] P

- Chip breaker for forged steel of automobile parts and general steels.
- Quad dots improve productivity through efficient chip control at high feed.
- Angle land minimizes cutting force.

➤ Features of LP Chip Breaker

Front dot

- Higher stability of chip curls at high feed
- Excellent chip control when copying
- Lower cutting force at low depth of cut and high feed

Variable land

- Less crater wear
- Prevents chipping on minor cutting edge.

Flat zone

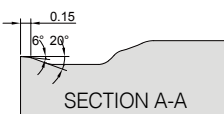

- Larger chip pocket for better chip evacuation at high feed
- Reduced cutting force with larger contact surface of chips

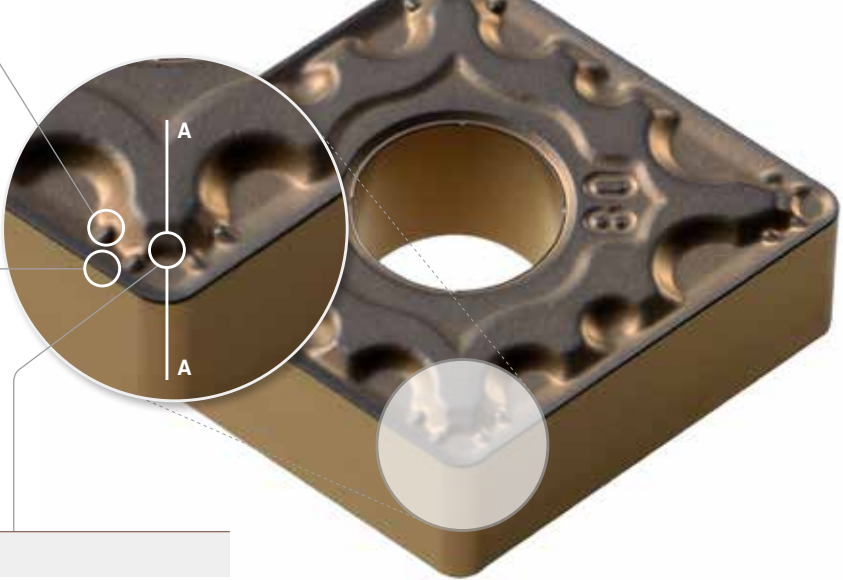

➤ Cutting Performance (Evaluation of chip map)

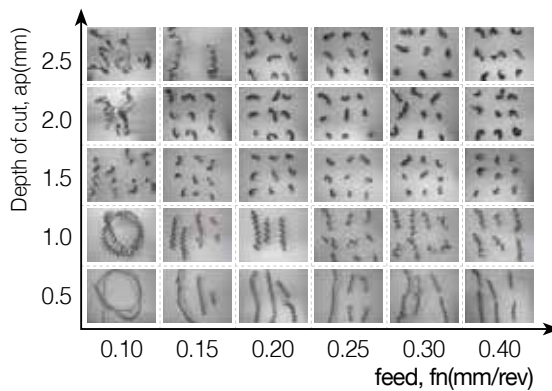

➤ Application Range (For medium to finish cutting)

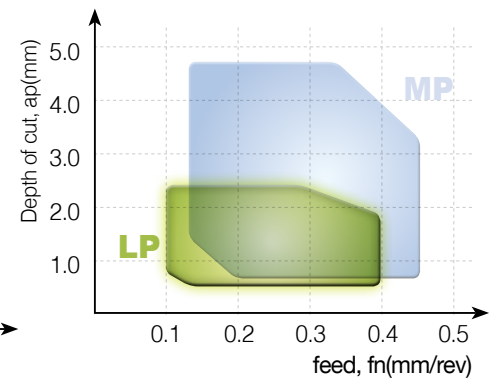

- **Workpiece** C50 (Forged steel), Ø100, External machining
- **Cutting conditions** vc(m/min) = 250, ap(mm) = 0.5~2.5, fn(mm/rev) = 0.1~0.4, wet
- **Tools** CNMG120408-LP

➔ Stable chip control is possible even at low depth of cut.

➤ Cutting Performance (Evaluation of wear resistance)

- Workpiece 42CrMo4 (Alloy steel), Ø100, External machining
- Cutting conditions $vc(m/min) = 280$, $ap(mm) = 1.0$, $fn(mm/rev) = 0.25 / 0.40$, wet
- Tools CNMG120408-□□

Longer tool life due to lower cutting force at both medium feed(0.25mm/rev) and high feed(0.40mm/rev)

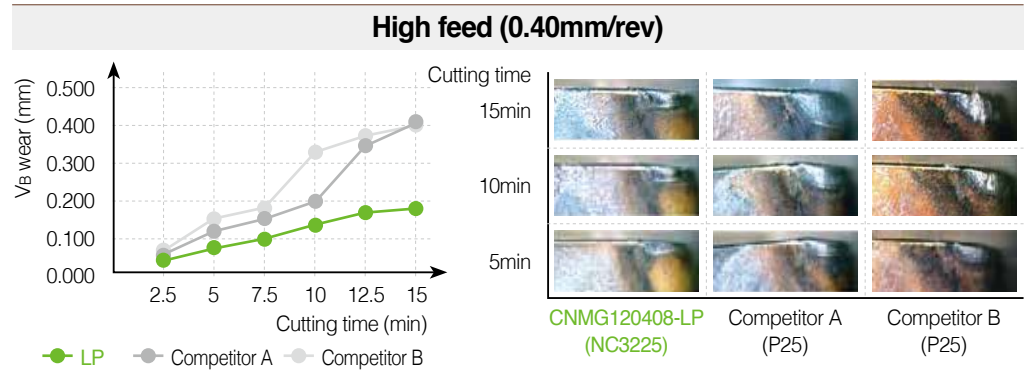
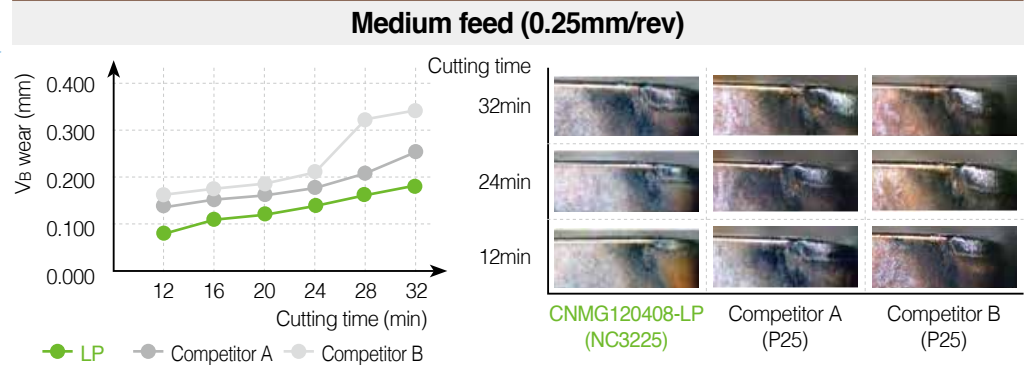

➤ Cutting Performance (Evaluation of cutting force)

- Workpiece C45 (Carbon steel), Ø100, External machining
- Cutting conditions $vc(m/min) = 250$, $ap(mm) = 1.0$, $fn(mm/rev) = 0.25 / 0.40$, wet
- Tools CNMG120408-□□

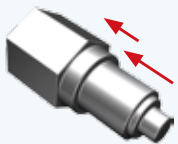

Lower cutting force at medium feed(0.25mm/rev) and high feed(0.40mm/rev)

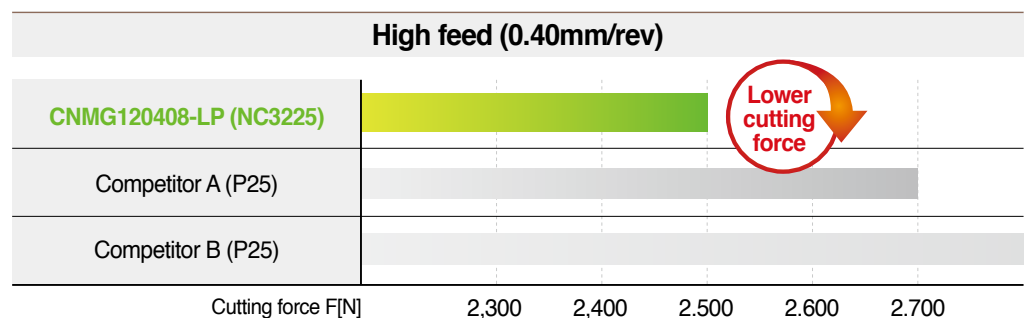
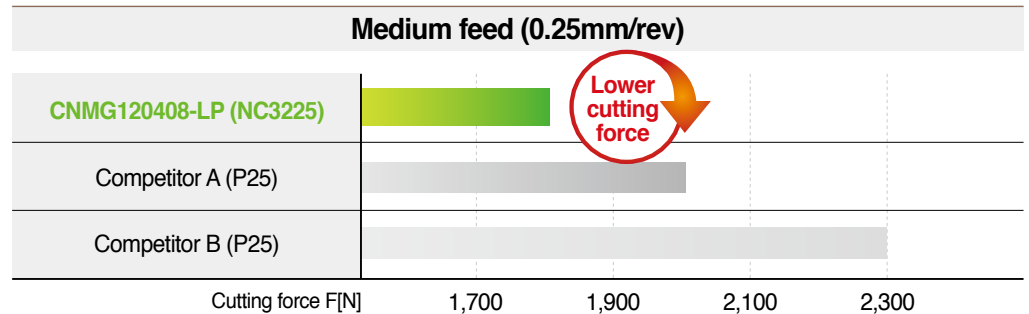

MP / LP Chip Breaker

MP Chip Breaker [Positive (for medium cutting)] P

- A single-sided chip breaker for forged steel of automobile parts and normal steel.
- Sharp cutting edges and wide chip pockets enable low cutting loads and improved surface finish and tool life.
- Three dimensional two step dots perform stable chip control even in machining uneven surfaces.

Features of MP Chip Breaker (Positive)

3D chip breaker of two step dots

- Stable chip control in machining uneven surfaces
- Higher stability of chip curls at varying depth of cuts and feeds

Stronger edge

- Higher stability against sudden impact during operation

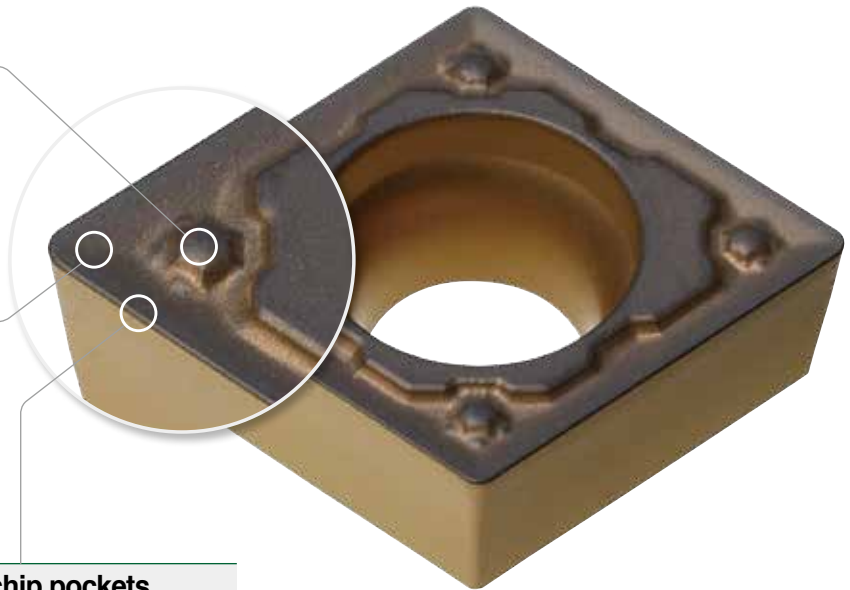

Sharp cutting edges and wide chip pockets

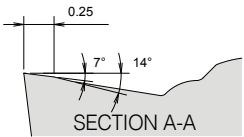

- Improved cutting performance and reduced cutting loads
- Stable chip curls in various workpieces

Cutting Performance (Evaluation of chip map)

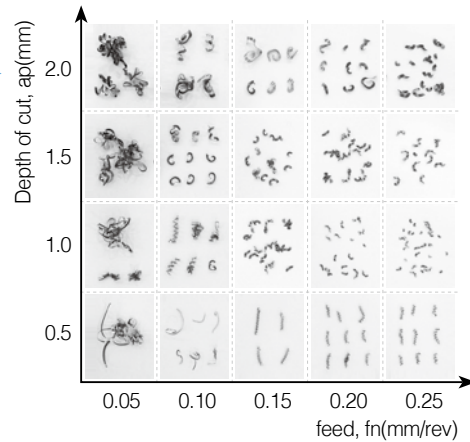

• Higher stability of chip curls even at varying cutting conditions

Application Range (For medium cutting)

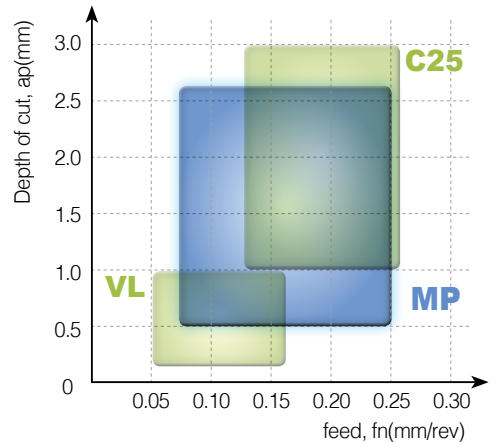

- Workpiece 42CrMo4 (Alloy steel), Ø100, External machining
- Cutting conditions $vc(m/min) = 250$, $ap(mm) = 0.5\sim 2.5$, $fn(mm/rev) = 0.05\sim 0.25$, wet
- Tools CCMT09T304-MP

➤ Cutting Performance (Evaluation of wear resistance)

- Workpiece 42CrMo4 (Alloy steel), Ø30, Internal machining
- Cutting conditions $vc(m/min) = 200$, $ap(mm) = 1.5$, $fn(mm/rev) = 0.2$, wet
- Tools CCMT09T304-MP (NC3220)

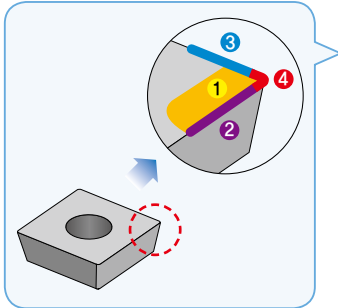

Comparison of Wear (After 7 passes)

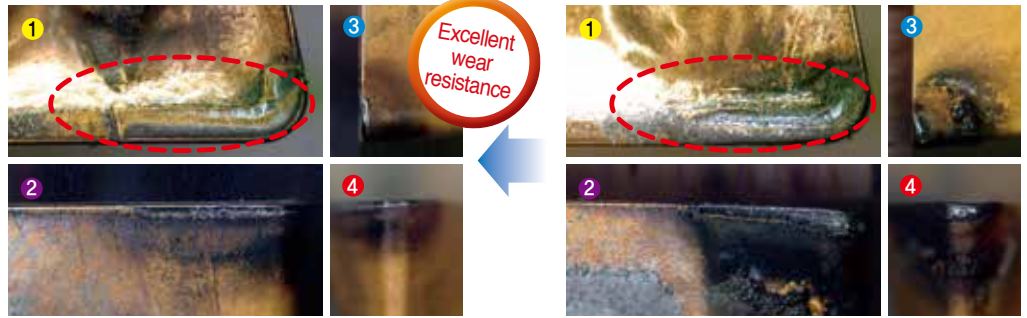

[MP]

[Competitor]

- Longer tool life due to lower cutting force at minor cutting edges by the use of wider chip breakers than competitor's

Comparison Graph of Wear Amount (V_B)

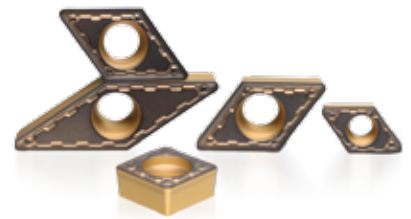
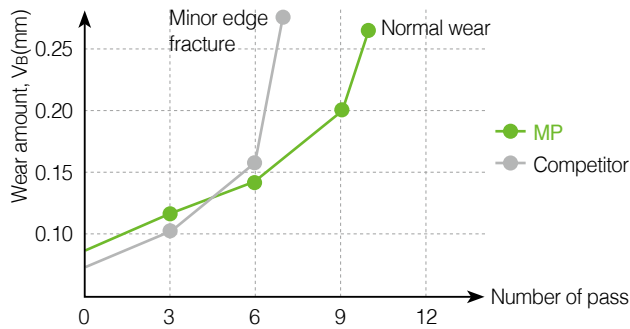

➤ Cutting Performance (Evaluation of toughness)

- Workpiece C45 (Carbon steel), Ø100 (4 grooves), External machining
- Cutting conditions $vc(m/min) = 100$, $ap(mm) = 0.5$, $fn(mm/rev) = 0.1$, wet
- Tools CCMT09T308-MP (NC3225)



- NC3225 has **45% longer tool life** than competitor's (P25).
- MP Chip breaker ensures **stable tool life** between corners **due to effective chip control**.

Test Result

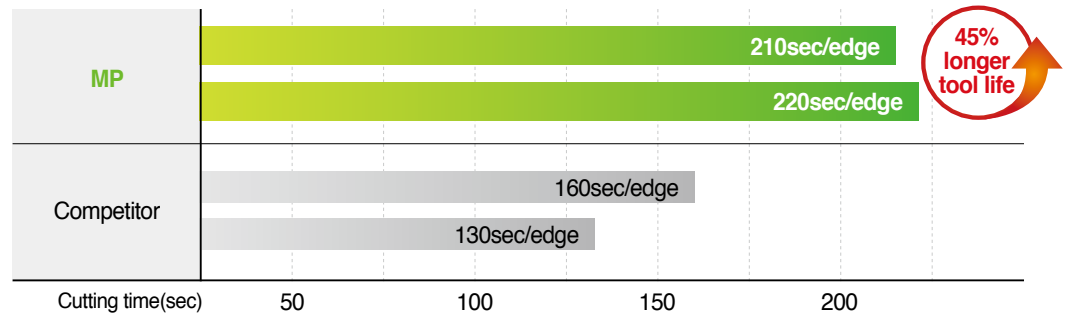

Application Examples of Automobile Parts (MP Negative)

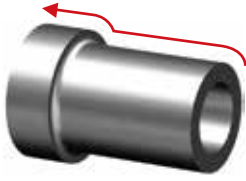

Engine parts (Cylinder block part)

- Workpiece: 41CrNiMo2 molding
- Cutting conditions: $vc(m/min) = 100$, $ap(mm) = 3.0$, $fn(mm/rev) = 0.15$, wet
- Tools: CNMG120408-MP

MP (NC3225)

60ea/edge

30% more

Competitor A (P25)

45ea/edge

- 30% longer tool life than competitor A(P25) due to reduced cutting force and smooth chip evacuation when machining outer surface at high depth of cut(3.0mm)



Engine parts (Nipple)

- Workpiece: C20
- Cutting conditions: $vc(m/min) = 250\sim380$, $ap(mm) = 1.5\sim2.0$, $fn(mm/rev) = 0.2\sim0.3$, wet
- Tools: CNMG120412-MP

MP (NC3215)

180ea/edge

20% more

Competitor B (P15)

150ea/edge

- Smooth chip evacuation and stable tool life in different cutting conditions and workpieces
20% longer tool life than competitor B(P15)

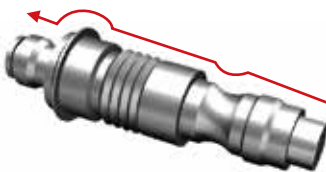

Steering system (Output shaft)

- Workpiece: C40 cold forging
- Cutting conditions: $vc(m/min) = 170$, $ap(mm) = 2.7\sim3.0$, $fn(mm/rev) = 0.3$, wet
- Tools: DNMG150408-MP

MP (NC3215)

180ea/edge

Higher stability

Competitor C (P15)

150ea/edge

- Higher stability than competitor C(P15) by preventing chip curls of cold forged steel to interfere cutting operation



Steering system (Wheel bearing)

- Workpiece: C55 hot forging
- Cutting conditions: $vc(m/min) = 230$, $ap(mm) = 0.5\sim1.5$, $fn(mm/rev) = 0.3$, wet
- Tools: CNMG120408-MP

MP (NC3225)

100ea/edge

20% more

Competitor D (P30)

80ea/edge

- Stable tool life in interrupted cutting and high hardness forged steel machining
20% longer tool life than competitor D(P30)

⇒ Application Examples of Automobile Parts (LP Negative)

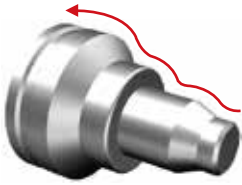

Steering system (BJ case)

- Workpiece C45 cold forging
- Cutting conditions $vc(m/min) = 200\sim 250$, $ap(mm) = 1.0\sim 2.0$, $fn(mm/rev) = 0.25\sim 0.35$, wet
- Tools DNMG150612-LP

LP (NC3215)	120ea/edge
Competitor E (P15)	90ea/edge

30% more

- ➔ Wide chip pockets improve chip evacuation and lower cutting force to avoid wear. 30% longer tool life than competitor E(P15)

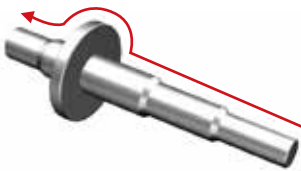

Transmission parts (Input shaft)

- Workpiece 20Cr4 cold forging
- Cutting conditions $vc(m/min) = 160$, $ap(mm) = 1.0$, $fn(mm/rev) = 0.13$, wet
- Tools DNMG150608-LP

LP (NC3225)	110ea/edge
Competitor F (P25)	80ea/edge

35% more

- ➔ Stability in combination of interrupted and continuous machining 30% longer tool life than competitor F(P25)



Steering system (Tripod Housing)

- Workpiece C50 cold forging
- Cutting conditions $vc(m/min) = 200$, $ap(mm) = 1.0$, $fn(mm/rev) = 0.27$, wet
- Tools DNMG150608-LP

LP (NC3225)	360ea/edge
Competitor G (P25)	300ea/edge

20% more

- ➔ 20% longer, and more stable tool life than competitor G(P25) thanks to reinforced cutting edges in light interruptions

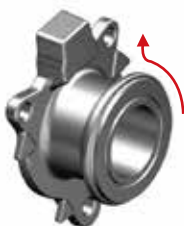

Engine parts (Cylinder)

- Workpiece C55 cold forging
- Cutting conditions $vc(m/min) = 220$, $ap(mm) = 1.5$, $fn(mm/rev) = 0.12$, wet
- Tools CNMG120408-LP

LP (NC3215)	36ea/edge
Competitor H (P15)	30ea/edge

20% more

- ➔ 25% longer, and more stable tool life than competitor H(P15) thanks to secured chip evacuation even under unstable chip control

Application Examples of Automobile Parts (MP Positive)

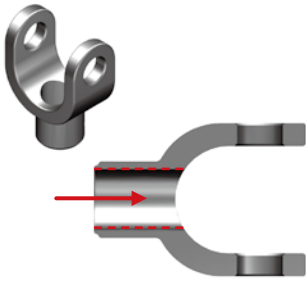

Steering system (T-yoke)

- Workpiece: C45 (Carbon steel)
- Cutting conditions: $vc(m/min) = 160$, $ap(mm) = 0.8$, $fn(mm/rev) = 0.2$, wet
- Tools: CCMT09T304-MP (NC3225)

MP (NC3225)	80ea/edge
Competitor A (P25)	60ea/edge



- Increased productivity and stable tool life due to excellent chip control
30% longer tool life than competitor A

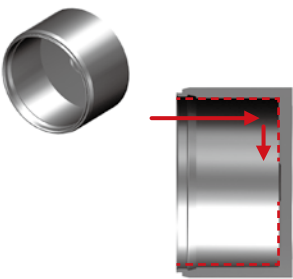

Steering system (Outer-cup)

- Workpiece: 20Cr4 (Cold forging)
- Cutting conditions: $vc(m/min) = 135$, $ap(mm) = 0.5\sim 1.0$, $fn(mm/rev) = 0.32$, wet
- Tools: DCMT11T304-MP (NC3225)

MP (NC3225)	320ea/edge
Competitor B (P25)	260ea/edge



- Excellent surface finish in internal machining due to sharp cutting edges
20% longer tool life than competitor B

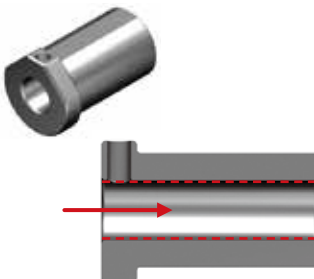

Machine tool (Tool sleeve)

- Workpiece: C45 (Carbon steel)
- Cutting conditions: $vc(m/min) = 200$, $ap(mm) = 0.5\sim 2.0$, $fn(mm/rev) = 0.15$, wet
- Tools: CCMT09T304-MP (NC3215)

MP (NC3215)	65ea/edge
Competitor C (P15)	50ea/edge



- Extended insert life when finishing and roughing due to reduced cutting force
20% longer tool life than competitor C

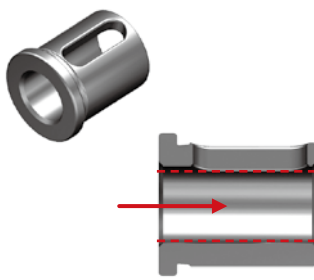

Machine tool (Tool sleeve)

- Workpiece: C45 (Carbon steel)
- Cutting conditions: $vc(m/min) = 150$, $ap(mm) = 0.5\sim 1.5$, $fn(mm/rev) = 0.25$, wet
- Tools: CCMT09T308-MP (NC3225)

MP (NC3225)	140ea/edge
Competitor D (P25)	120ea/edge



- Stable tool life in interrupted cutting of internal diameters due to reinforced cutting edges
15% longer tool life than competitor D

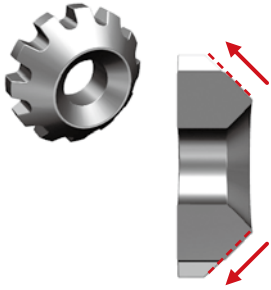

Automotive gear (Transmission part)

- Workpiece C45 (Cold forging)
- Cutting conditions $vc(m/min) = 185$, $ap(mm) = 0.4$, $fn(mm/rev) = 0.1$, wet
- Tools CCMT09T304-MP (CN2500)

MP (CN2500)	1,300ea/edge
Competitor E (P25)	800ea/edge



➔ Increased tool life when machining outer surface of forged steels due to excellent cutting performance 40% longer tool life than competitor E

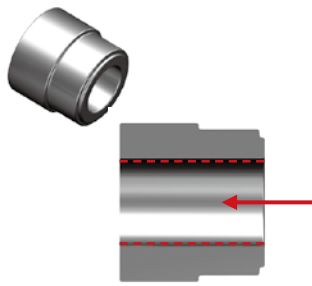

Oil port (Engine part)

- Workpiece C45 (Cast steel)
- Cutting conditions $vc(m/min) = 90$, $ap(mm) = 0.5$, $fn(mm/rev) = 0.1$, wet
- Tools CCMT060204-MP (NC3225)

MP (NC3225)	1,850ea/edge
Competitor F (P25)	1,050ea/edge





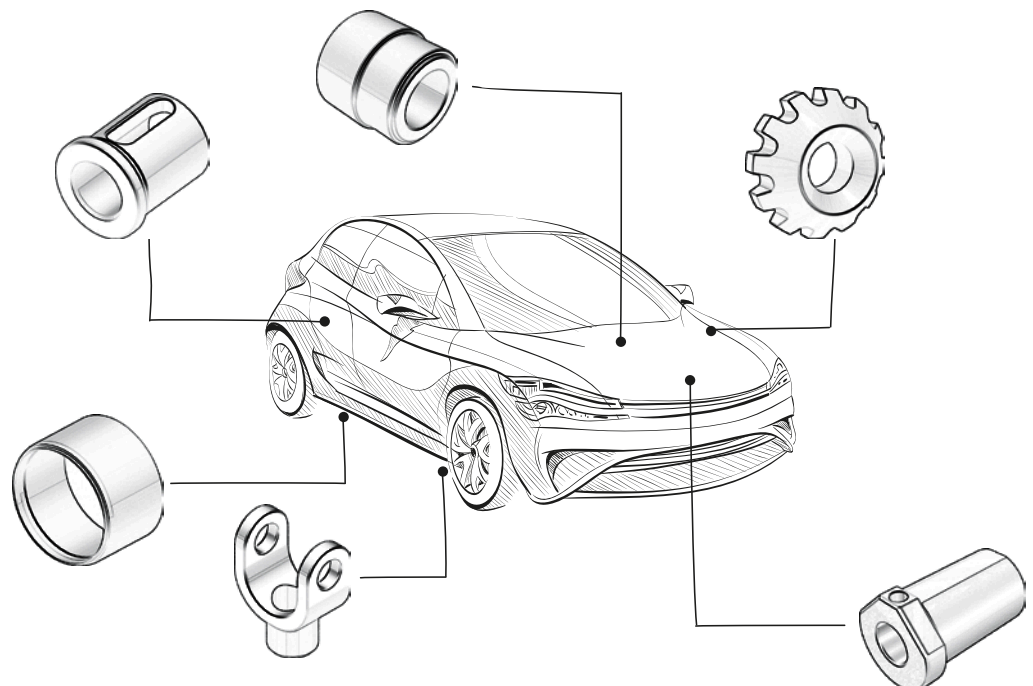



➔ Excellent tool life and stable chip control in internal machining of small components 40% longer tool life than competitor F



MP / LP Chip Breaker

⇒ Available Stock (MP Negative)







(mm)

Insert shape	Designation	Coated										Dimensions (mm)					Cutting conditions	
		NC3215	NC3225	NC5330	NC9115	NC9125	NC9135	NC6215	PC8105	PC8110	PC8115	l	d	t	r	d ₁	Depth of cut ap(mm)	Feed fn(mm/rev)
	CNMG	090304-MP	●	●	●							9.2	9.525	3.18	0.4	3.81	0.4~3.8	0.10~0.40
		090308-MP	●	●	●							8.8	9.525	3.18	0.8	3.81	0.5~4.0	0.15~0.40
		090312-MP										8.4	9.525	3.18	1.2	3.81	0.8~4.2	0.15~0.50
		120404-MP	●	●	●	●	●	●	●	●	●	12.4	12.7	4.76	0.4	5.16	0.4~4.0	0.10~0.40
		120408-MP	●	●	●	●	●	●	●	●	●	12.0	12.7	4.76	0.8	5.16	0.5~4.5	0.15~0.45
		120412-MP	●	●	●	●	●	●	●	●	●	11.6	12.7	4.76	1.2	5.16	0.8~5.0	0.15~0.50
		120416-MP	●	●	●	●	●	●				11.2	12.7	4.76	1.6	5.16	1.0~5.0	0.28~0.55
		160608-MP	●	●	●	●	●	●				15.3	15.875	6.35	0.8	6.35	0.5~7.0	0.15~0.45
		160612-MP	●	●	●	●	●	●				14.8	15.875	6.35	1.2	6.35	0.8~7.0	0.15~0.50
		160616-MP	●	●	●							14.4	15.875	6.35	1.6	6.35	1.0~7.0	0.15~0.60
		190608-MP										18.5	19.05	6.35	0.8	7.93	0.5~8.5	0.15~0.50
		190612-MP										18.1	19.05	6.35	1.2	7.93	0.8~8.5	0.18~0.60
190616-MP				●	●	●				17.7	19.05	6.35	1.6	7.93	1.0~8.5	0.20~0.60		
	DNMG	110404-MP	●	●	●						11.2	9.525	4.76	0.4	3.81	0.4~3.8	0.10~0.40	
		110408-MP	●	●	●						10.8	9.525	4.76	0.8	3.81	0.5~4.0	0.15~0.40	
		110412-MP									10.4	9.525	4.76	1.2	3.81	0.8~4.2	0.15~0.50	
		150404-MP	●	●	●	●	●	●		●	●	15.1	12.7	4.76	0.4	5.16	0.4~4.0	0.10~0.40
		150408-MP	●	●	●	●	●	●	●	●	●	14.7	12.7	4.76	0.8	5.16	0.5~4.5	0.15~0.45
		150412-MP	●	●	●	●	●	●	●	●	●	14.4	12.7	4.76	1.2	5.16	0.8~5.0	0.15~0.50
		150604-MP	●	●	●	●	●	●	●	●	●	15.1	12.7	6.35	0.4	5.16	0.4~4.0	0.10~0.40
		150608-MP	●	●	●	●	●	●	●	●	●	14.7	12.7	6.35	0.8	5.16	0.5~4.5	0.15~0.45
		150612-MP	●	●	●	●	●	●	●	●	●	14.4	12.7	6.35	1.2	5.16	0.8~5.0	0.15~0.50
	SNMG	090304-MP	●	●	●						9.1	9.525	3.18	0.4	3.81	0.4~3.8	0.10~0.40	
		090308-MP	●	●	●						8.7	9.525	3.18	0.8	3.81	0.5~4.0	0.15~0.40	
		120404-MP	●	●	●	●	●	●	●	●	12.3	12.7	4.76	0.4	5.16	0.4~4.0	0.10~0.40	
		120408-MP	●	●	●	●	●	●	●	●	11.9	12.7	4.76	0.8	5.16	0.5~4.5	0.15~0.45	
		120412-MP	●	●	●	●	●	●			11.5	12.7	4.76	1.2	5.16	0.8~5.0	0.15~0.50	
		120416-MP	●	●	●						11.1	12.7	4.76	1.6	5.16	1.0~5.0	0.28~0.55	
	TNMG	160404-MP	●	●	●	●	●	●	●	●	15.5	9.525	4.76	0.4	3.81	0.4~3.5	0.10~0.35	
		160408-MP	●	●	●	●	●	●	●	●	14.5	9.525	4.76	0.8	3.81	0.5~4.0	0.15~0.45	
		160412-MP	●	●	●	●	●	●	●	●	13.5	9.525	4.76	1.2	3.81	0.8~4.5	0.15~0.50	
		220404-MP	●	●	●	●	●	●			21.0	12.7	4.76	0.4	5.16	0.4~5.0	0.10~0.35	
		220408-MP	●	●	●	●	●	●			20.0	12.7	4.76	0.8	5.16	0.5~5.5	0.15~0.45	
		220412-MP	●	●	●	●	●	●			19.0	12.7	4.76	1.2	5.16	0.8~6.0	0.15~0.50	
		220416-MP	●	●	●						18.0	12.7	4.76	1.6	5.16	1.0~6.0	0.20~0.55	
	VNMG	160404-MP	●	●	●	●	●	●	●	●	15.6	9.525	4.76	0.4	3.81	0.4~3.5	0.10~0.40	
		160408-MP	●	●	●	●	●	●	●	●	14.6	9.525	4.76	0.8	3.81	0.5~4.0	0.15~0.45	
		160412-MP	●	●	●						13.6	9.525	4.76	1.2	3.81	0.8~4.5	0.15~0.50	
	WNMG	060404-MP	●	●	●						6.2	9.525	4.76	0.4	3.81	0.4~2.8	0.10~0.40	
		060408-MP	●	●	●						6.1	9.525	4.76	0.8	3.81	0.5~3.0	0.15~0.45	
		060412-MP									6.0	9.525	4.76	1.2	3.81	0.8~3.2	0.15~0.50	
		080404-MP	●	●	●	●	●	●	●	●	●	8.4	12.7	4.76	0.4	5.16	0.4~4.0	0.10~0.40
		080408-MP	●	●	●	●	●	●	●	●	●	8.3	12.7	4.76	0.8	5.16	0.5~4.5	0.15~0.45
		080412-MP	●	●	●	●	●	●	●	●	●	8.2	12.7	4.76	1.2	5.16	0.8~5.0	0.15~0.50
		080416-MP	●	●	●						8.1	12.7	4.76	1.6	5.16	1.0~5.0	0.15~0.50	

● : Managed item

⇒ Available Stock (LP Negative)

(mm)







Insert shape	Designation	Coated										Dimensions (mm)					Cutting conditions	
		NC3215	NC3225	NC5330	NC9115	NC9125	NC9135	NC6215	PC8105	PC8110	PC8115	l	d	t	r	d ₁	Depth of cut ap(mm)	Feed fn(mm/rev)
	CNMG	090308-LP										8.8	9.525	3.18	0.8	3.81	0.3~1.5	0.10~0.30
		120404-LP	●	●	●							12.4	12.7	4.76	0.4	5.16	0.3~2.0	0.10~0.35
		120408-LP	●	●	●							12.0	12.7	4.76	0.8	5.16	0.5~2.5	0.10~0.40
		120412-LP	●	●	●							11.6	12.7	4.76	1.2	5.16	0.8~3.0	0.13~0.45
	DNMG	110404-LP										11.2	9.525	4.76	0.4	3.81	0.3~1.5	0.07~0.30
		110408-LP										10.8	9.525	4.76	0.8	3.81	0.3~1.5	0.10~0.40
		150404-LP	●	●	●							15.1	12.7	4.76	0.4	5.16	0.3~2.0	0.10~0.35
		150408-LP	●	●	●							14.7	12.7	4.76	0.8	5.16	0.5~2.5	0.10~0.40
		150412-LP	●	●	●							14.4	12.7	4.76	1.2	5.16	0.8~3.0	0.13~0.45
		150604-LP	●	●	●							15.1	12.7	6.35	0.4	5.16	0.3~2.0	0.10~0.35
		150608-LP	●	●	●							14.7	12.7	6.35	0.8	5.16	0.5~2.5	0.10~0.40
		150612-LP	●	●	●							14.4	12.7	6.35	1.2	5.16	0.8~3.0	0.13~0.45
	SNMG	090308-LP										8.7	9.525	3.18	0.8	3.81	0.3~1.5	0.10~0.30
		120404-LP	●	●	●							12.3	12.7	4.76	0.4	5.16	0.3~2.0	0.10~0.35
		120408-LP	●	●	●							11.9	12.7	4.76	0.8	5.16	0.5~2.5	0.10~0.40
	TNMG	160404-LP	●	●	●							15.5	9.525	4.76	0.4	3.81	0.3~1.5	0.10~0.30
		160408-LP	●	●	●							14.5	9.525	4.76	0.8	3.81	0.3~2.0	0.10~0.35
		160412-LP										13.5	9.525	4.76	1.2	3.81	0.5~2.5	0.10~0.40
	VNMG	160404-LP										15.6	9.525	4.76	0.4	3.81	0.3~1.5	0.10~0.35
		160408-LP										14.6	9.525	4.76	0.8	3.81	0.5~2.0	0.10~0.40
		160412-LP										13.6	9.525	4.76	1.2	3.81	0.8~2.5	0.13~0.45
	WNMG	060408-LP										6.1	9.525	4.76	0.8	3.81	0.3~1.5	0.10~0.30
		080404-LP	●	●	●							8.4	12.7	4.76	0.4	5.16	0.3~1.5	0.10~0.30
		080408-LP	●	●	●							8.3	12.7	4.76	0.8	5.16	0.3~2.0	0.10~0.35
		080412-LP	●	●	●							8.2	12.7	4.76	1.2	5.16	0.5~2.5	0.10~0.40

● : Managed item

MP / LP Chip Breaker

Available Stock (MP Positive)

(mm)

Insert shape	Designation	Cermet				Coated										Dimensions (mm)					Cutting conditions				
		CN1500	CN2500	CC1500	CC2500	NC3010	NC3215	NC3225	NC5330	NC9115	NC9125	NC9135	PC5300	PC5400	PC8105	PC8110	PC8115	l	d	t	r	d ₁	Depth of cut ap(mm)	Feed fn(mm/rev)	
	CCMT	060202-MP	●	●	●	●		●	●	●	●	●	●	●	●	●	●	6.2	6.35	2.38	0.2	2.8	0.20~1.50	0.04~0.12	
		060204-MP	●	●	●	●		●	●	●	●	●	●	●	●	●	●	6.0	6.35	2.38	0.4	2.8	0.30~1.50	0.05~0.15	
		060208-MP																	5.6	6.35	2.38	0.8	2.8	0.50~2.00	0.07~0.15
		09T302-MP	●	●	●	●	●	●	●	●	●	●	●	●	●	●	●	●	9.4	9.525	3.97	0.2	4.4	0.30~2.00	0.07~0.15
		09T304-MP	●	●	●	●	●	●	●	●	●	●	●	●	●	●	●	●	9.2	9.525	3.97	0.4	4.4	0.50~2.50	0.08~0.25
		09T308-MP	●	●	●	●	●	●	●	●	●	●	●	●	●	●	●	●	8.8	9.525	3.97	0.8	4.4	0.50~2.50	0.10~0.30
		120404-MP																	12.4	12.7	4.76	0.4	5.5	0.50~3.50	0.10~0.30
		120408-MP																	12.0	12.7	4.76	0.8	5.5	0.80~3.50	0.15~0.35
	DCMT	070202-MP	●	●	●	●		●	●	●	●	●	●	●	●	●	●	7.5	6.35	2.38	0.2	2.8	0.12~1.80	0.04~0.12	
		070204-MP	●	●	●	●		●	●	●	●	●	●	●	●	●	●	7.3	6.35	2.38	0.4	2.8	0.30~1.80	0.05~0.15	
		070208-MP	●	●	●	●		●	●	●	●	●	●	●	●	●	●	6.8	6.35	2.38	0.8	2.8	0.30~1.80	0.08~0.22	
		11T302-MP	●	●	●	●	●	●	●	●	●	●	●	●	●	●	●	●	11.4	9.525	3.97	0.2	4.4	0.30~2.00	0.04~0.15
		11T304-MP	●	●	●	●	●	●	●	●	●	●	●	●	●	●	●	●	11.2	9.525	3.97	0.4	4.4	0.50~2.30	0.08~0.20
		11T308-MP	●	●	●	●	●	●	●	●	●	●	●	●	●	●	●	●	10.8	9.525	3.97	0.8	4.4	0.50~2.30	0.10~0.30
	SCMT	09T304-MP						●	●	●	●	●	●	●	●	●	9.1	9.525	3.97	0.4	4.4	0.30~2.80	0.05~0.25		
		09T308-MP						●	●	●	●	●	●	●	●	●	8.7	9.525	3.97	0.8	4.4	0.50~2.80	0.10~0.30		
		120408-MP									●	●	●	●	●	●	11.9	12.7	4.76	0.8	5.5	0.80~3.50	0.15~0.35		
	TCMT	090204-MP										●	●	●			8.6	5.56	2.38	0.4	2.5	0.10~1.00	0.03~0.15		
		090208-MP										●	●	●			7.6	5.56	2.38	0.8	2.5	0.10~1.00	0.05~0.18		
		110202-MP						●	●	●	●	●	●	●	●	●	10.5	6.35	2.38	0.2	2.8	0.20~1.50	0.03~0.12		
		110204-MP						●	●	●	●	●	●	●	●	●	10.0	6.35	2.38	0.4	2.8	0.20~15.0	0.05~0.15		
		110208-MP						●	●	●	●	●	●	●	●	●	9.0	6.35	2.38	0.8	2.8	0.25~2.00	0.10~0.28		
		16T304-MP	●	●	●	●	●	●	●	●	●	●	●	●	●	●	●	15.5	9.525	3.97	0.4	4.4	0.30~2.50	0.08~0.20	
		16T308-MP	●	●	●	●	●	●	●	●	●	●	●	●	●	●	●	14.5	9.525	3.97	0.8	4.4	0.50~2.50	0.10~0.30	
		16T312-MP						●	●	●	●	●	●	●	●	●	13.5	9.525	3.97	1.2	4.4	0.50~2.50	0.20~0.40		
	TPMT	110304-MP	●	●	●	●							●	●			10.0	6.35	3.18	0.4	3.4	0.20~1.50	0.05~0.20		
		110308-MP															9.0	6.35	3.18	0.8	3.4	0.25~2.00	0.10~0.28		
		160404-MP															15.5	9.525	4.76	0.4	4.4	0.30~2.50	0.08~0.20		
		160408-MP															14.5	9.525	4.76	0.8	4.4	0.50~2.50	0.10~0.30		
	VBMT	110304-MP															10.0	6.35	2.38	0.4	2.8	0.20~1.50	0.05~0.15		
		110308-MP															9.0	6.35	2.38	0.8	2.8	0.25~2.00	0.10~0.28		
		160404-MP	●	●	●	●	●	●	●	●	●	●	●	●	●	●	15.6	9.525	4.76	0.4	4.4	0.30~2.00	0.08~0.20		
		160408-MP	●	●	●	●	●	●	●	●	●	●	●	●	●	●	14.6	9.525	4.76	0.8	4.4	0.50~2.30	0.10~0.25		
		160412-MP	●	●				●	●	●	●	●	●	●	●	●	13.5	9.525	4.76	1.2	4.4	0.50~2.30	0.10~0.35		
	VCMT	080202-MP															8.0	4.76	2.38	0.2	2.3	0.10~1.00	0.03~0.15		
		080204-MP															7.5	4.76	2.38	0.4	2.3	0.10~1.00	0.05~0.18		
		160404-MP						●	●		●	●	●		●	●	15.6	9.525	4.76	0.4	4.4	0.30~2.00	0.08~0.18		
		160408-MP						●	●		●	●	●		●	●	14.6	9.525	4.76	0.8	4.4	0.50~2.30	0.10~0.23		
		160412-MP									●	●	●		●	●	13.5	9.525	4.76	1.2	4.4	0.50~2.30	0.10~0.33		

● : Managed item



Holystar B/D, 1350, Nambusunhwan-ro, Geumcheon-gu, Seoul, 08536, Korea
Tel : +82-2-522-3181 Fax : +82-2-522-3184, +82-2-3474-4744 Web : www.korloy.com E-mail : export@korloy.com



620 Maple Avenue, Torrance, CA 90503, USA
Tel : +1-310-782-3800 Toll Free : +1-888-711-0001 Fax : +1-310-782-3885
www.korloyamerica.com E-mail : sales@korloy.us



Plot NO.415, Sector 8, IMT Manesar, Gurgaon 122051, Haryana, INDIA
Tel : +91-124-4391790 Fax : +91-124-4050032
www.korloyindia.com E-mail : sales.kip@korloy.com



Gablunzer Str. 25-27, 61440 Oberursel, Germany
Tel : +49-6171-277-83-0 Fax : +49-6171-277-83-59
www.korloyeurope.com E-mail : sales@korloyeurope.com



Av. Aruana 280, conj.12, WLC, Alphaville, Barueri,
CEP06460-010, SP, Brasil
Tel : +55-11-4193-3810 E-mail : vendas@korloy.com