

Línea Pesaje y Dinamómetros

ACCESORIOS

Dinamómetro de aleación liviana serie PWHYCS de 1T a 100T IP67

Model / Modelo	PWHY5T	PWHY10T	PWHY25T	PWHY50T	PWHY100T
A	9 in / 230 mm	11 in / 280 mm	14.6 in / 370 mm	16.9 in / 430 mm	22.4 in / 570 mm
A1	6.3 in / 160 mm	7.4 in / 188 mm	9 in / 230 mm	10.2 in / 260 mm	5.4 in / 340 mm
B	3 in / 76 mm	3.5 in / 90 mm	0.9 in / 125 mm	5.9 in / 150 mm	8.3 in / 210 mm
W	1.3 in / 34 mm	1.8 mm / 47 mm	2.2 in / 55 mm	2.6 in / 65 mm	4.3 in / 108 mm
ØS	1.1 in / 28 mm	1.6 in / 40 mm	2.1 in / 53 mm	2.9 in / 73 mm	4.0 in / 102 mm
ØH	0.8 in / 21 mm	1.1 in / 28 mm	2.1 in / 53 mm	2.9 in / 73 mm	4.0 in / 102 mm

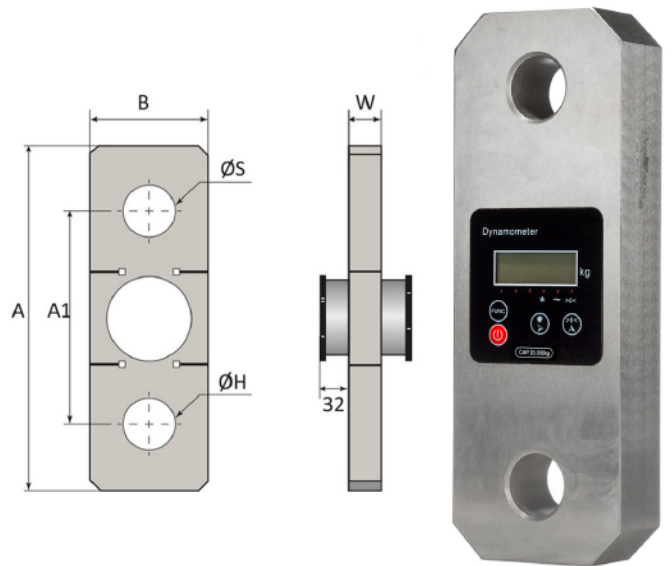

Dinamómetro de línea serie PWHY de 1t a 50t (largo alcance) IP68

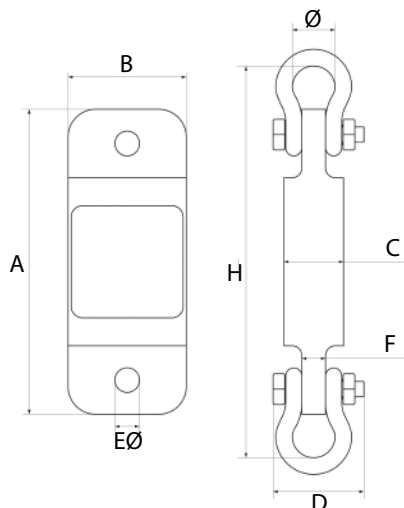

Model / Modelo	PWHYCS1T	PWHYCS5T	PWHYCS10T	PWHYCS20T	PWHYCS30T	PWHYCS50T
A	9 5/8 in	11 1/4 in	12 1/3 in	16.5 in	16.5 in	18.3 in
	244.5 mm	286 mm	318 mm	420 mm	420 mm	465 mm
B	3 3/4 in	4 in	4 1/2 in	4.8 in	5.4 in	5.9 in
	95.3 mm	102 mm	114 mm	128 mm	138 mm	150 mm
C	1 7/8 in	2 in	1 7/8 in	2.8 in	3.1 in	3.9 in
	47.6 mm	51 mm	48 mm	70 mm	80 mm	100 mm
D	2 13/16 in	4 7/8 in	6 1/2 in	10.2 in	11 in	12 in
	71.4 mm	124 mm	165 mm	260 mm	280 mm	305 mm
Ø	1 3/8 in	2 1/4 in	3 1/4 in	5 in	5.7 in	7.2 in
	34.9 mm	57 mm	83 mm	127 mm	146 mm	184 mm
H	12 in	16 in	19 1/2 in	25.9 in	29.1 in	36.6 in
	304.8 mm	406 mm	495 mm	660 mm	740 mm	930 mm
EØ	13/16 in	1 7/16 in	1 7/6 in			
	19.6 mm	37 mm	37 mm			
F	3/4 in	1 3/8 in	1 7/8 in			
	19.04 mm	35 mm	48 mm			

Dinamómetro a cable de acero serie PWHY-tr de 1t a 50t IP68

Capacity / Capacidad	H	B1	B2	L	Steel Rope/Cable de Acero
2000 lb / 1 t	3.8 in / 95.5 mm	1.6 in / 40 mm	2.4 in / 60 mm	7.1 in / 180 mm	ø1/4 - ø9/16 in ø6 - ø14 mm
4000 lb / 2 t	3.8 in / 95.5 mm	1.6 in / 40 mm	2.4 in / 60 mm	7.1 in / 180 mm	ø25/64 - ø54/64 in ø10 - ø18 mm
6000 lb / 3 t	3.8 in / 95.5 mm	1.6 in / 40 mm	2.4 in / 60 mm	7.1 in / 180 mm	ø15/32 - ø25/32 in ø12 - ø20 mm
10000 lb / 5 t	5.4 in / 136.5 mm	1.6 in / 40 mm	2.9 in / 75 mm	7.9 in / 200 mm	ø5/8 - ø1 1/32 in ø16 - ø26 mm
20000 lb / 10 t	7.7 in / 195 mm	2.4 in / 60 mm	4.3 in / 110 mm	10.2 in / 260 mm	ø15/16 - ø1 13/32 in ø24 - ø36 mm
50000 lb / 25 t	By Request Customizable / Adaptable Según Pedido				
100000lb / 50 t	By Request Customizable / Adaptable Según Pedido				

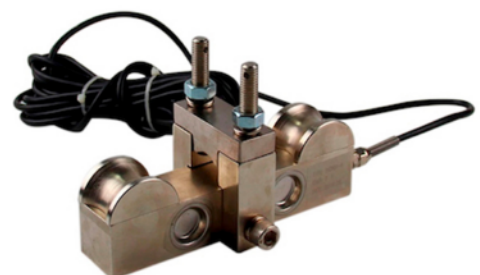
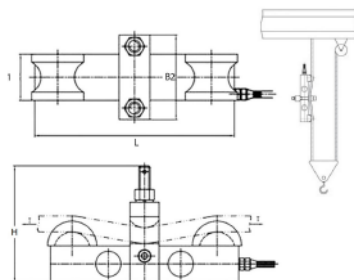

Control Remoto Simple con Visor para serie PWHY



MODELO: PWHY185

Detalles del Empaque

PH1 Altura Empaque	7 in / 16.5 cm
PW1 Ancho Empaque	4 in / 8 cm
PD1 Profundidad Empaque	2 in / 3 cm

MODELO: PWHY280

Detalles del Empaque

NW1 Peso Neto	5 lbs / 2 Kg	PH1 Altura Empaque	6 in / 15 cm
GW1 Peso Bruto	7 lbs / 3 Kg	PW1 Ancho Empaque	12 in / 30 cm
PD1 Profundidad Empaque	16 in / 40 cm		



Control Remoto con Impresora y Visor para serie PWHY

MODELO: PWHY680



- 1. Visor 240x128p / Display 240x128p
- 2. Teclado / Keyboard
- 3. Puerto USB / USB Port
- 4. Entrada cargador / Charger Input
- 5. Micro Impresora / Micro Printer

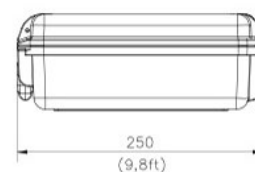
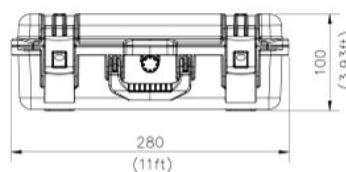
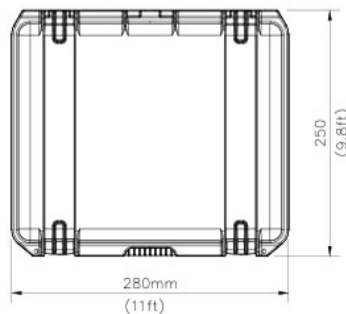

Displays para series PWHYD

MODELO: PWHYD8 - 8 pulgadas



MODELO: PWHYD5 - 5 pulgadas



Interfase Inalábrica PC Incluye Software

MODELO: PWATP



Antenas para series PWHYA

MODELO: PWHYA200 para 200 metros



MODELO: PWHYA300 para 300 metros

