



SATURN^evo

ZMS • ZGS

CENTRIFUGAL PUMPS

FOR SEAWATER AND CORROSIVE FLUIDS

ENTIRELY MADE OF FIBERGLASS

CLOSE OR LONG COUPLED

60 Hz



FIBERGLASS CENTRIFUGAL PUMPS

FOR SEAWATER AND CORROSIVE LIQUIDS

The evolved **SATURN EVO** range consists of horizontal centrifugal single-stage pumps compliant with ANSI/ASME B73.1 standards. The pump casing are made of FRP (fiberglass reinforced polyester) which neither requires protective coatings or metallic armour. Argal's **SATURN EVO** series offers the durability and strength at par with metal alloy construction.

Our **SATURN EVO** range is offered in two configurations - **ZGS** - long coupled with bearing housing and coupling (offered with SS or FRP base frames) and **ZMS** - close coupled.

CHEMICAL RESISTANCE AND MECHANICAL STRENGTH

Argal offers various formulations of resins to cover a broad range of corrosive chemicals and moderately abrasive liquids.

5 VERSIONS OF CONSTRUCTION

V1G: for corrosive liquids including acids, alkalis, detergents, brine and sea water.

V1A: for liquids with a low concentration of abrasion: fossil shell flour, ashes, titanium dioxide.

V1C: for corrosive liquids such as sodium hypochlorite (NaOCl) or hydrogen peroxide (H₂O₂);

V1F: for fluoride acid (HF) and other liquids with fluorine.

V1X: for operation in ATEX areas.

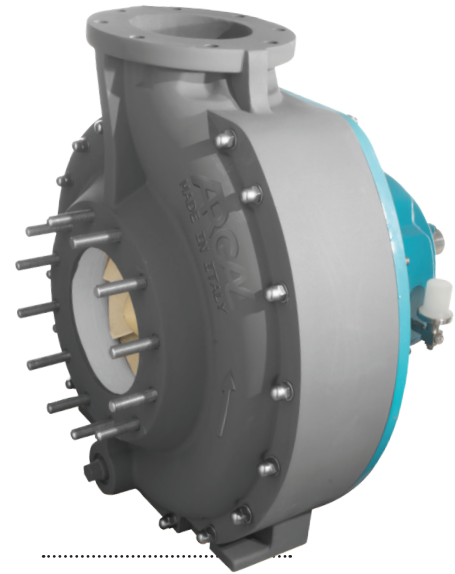

ZGS Pump 10x8x15
(V1X for ATEX areas)

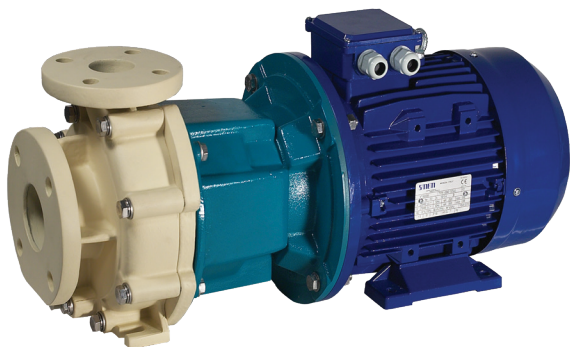

ZMS Pump 3x2x6
(V1G)

EXAMPLES OF APPLICATION

SECTORS	APPLICATIONS
Aquariums/Zoos	Saltwater
Chemical Process	Acids Chemical waste Waste Water
Desalination	Filtration Seawater Intake Chemical Transfer Concentrated Brine
Electric Utilities	Coal pile run-off
Electronics	Acids Chemical waste
Metal Finishing	Chromic acids Pickling acids Plating solutions
Petrochemical	Acids Chemical waste
Pharmaceutical	Organic Solvents
Pulp and Paper	Bleach
Mining	Abrasives and Corrosives
Scrubbers/Odor Control	Acids and Caustics

LONG-COUPLED “G”

The coupling of the pump to the motor with a flexible joint delivers an extended operational life to the mechanical parts of the pump and therefore is the preferred solution for heavy duty application and continuous applications. The back pull-out construction allows for dismantling the support of the pump and some hydraulic parts subjected to periodic inspection without disconnecting the casing from the piping of the plant or removing the electric motor from the base plate.

BACK PULL-OUT SYSTEM

ZGS pumps with elastic coupling are equipped with the back pull-out system that allows the dismantling of the internal and mechanic parts of the pump without disconnecting the casing from the fittings and without moving the motor.

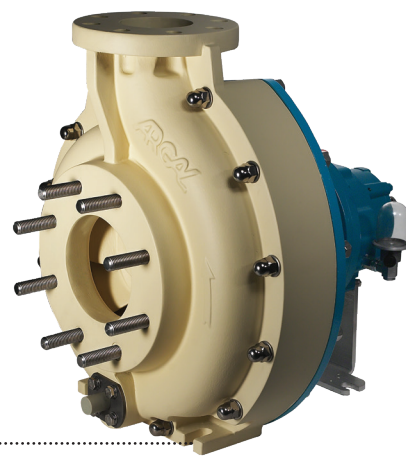
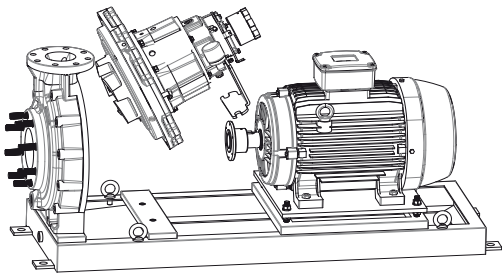

ZGS Pump 6x4x10
(V1G)

CLOSE-COUPLED “M”

The close-coupled series offers installations for proposed for power requirements for up to 37 kW with significant mechanical advantages. The shaft of the pump is supported by a bearing located in the lantern; this bearing counters the radial load of the shaft and by reducing its overhung section, it reduces the loads on the bearings of the electric motor contributing to extend the pump lifecycle. This solution is characterised by the reduction of the overall dimensions and allows installing these pumps in plants and compact systems.

ZMS'S PLUS a unique solution

The rolling bearing is intentionally located in the lantern junction to the electric motor for supporting the radial charges. It also reduces the cantilever extremity of the shaft and thus the charge carried by the motor bearings: a longer life cycle is ensured.

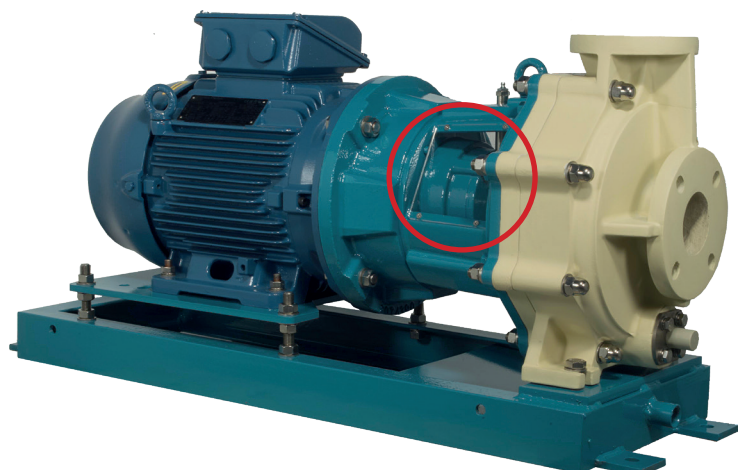

ZMS Pump 3x2x10
(V1G)

CONSTRUCTION & CURVES

60 Hz

3500 rpm

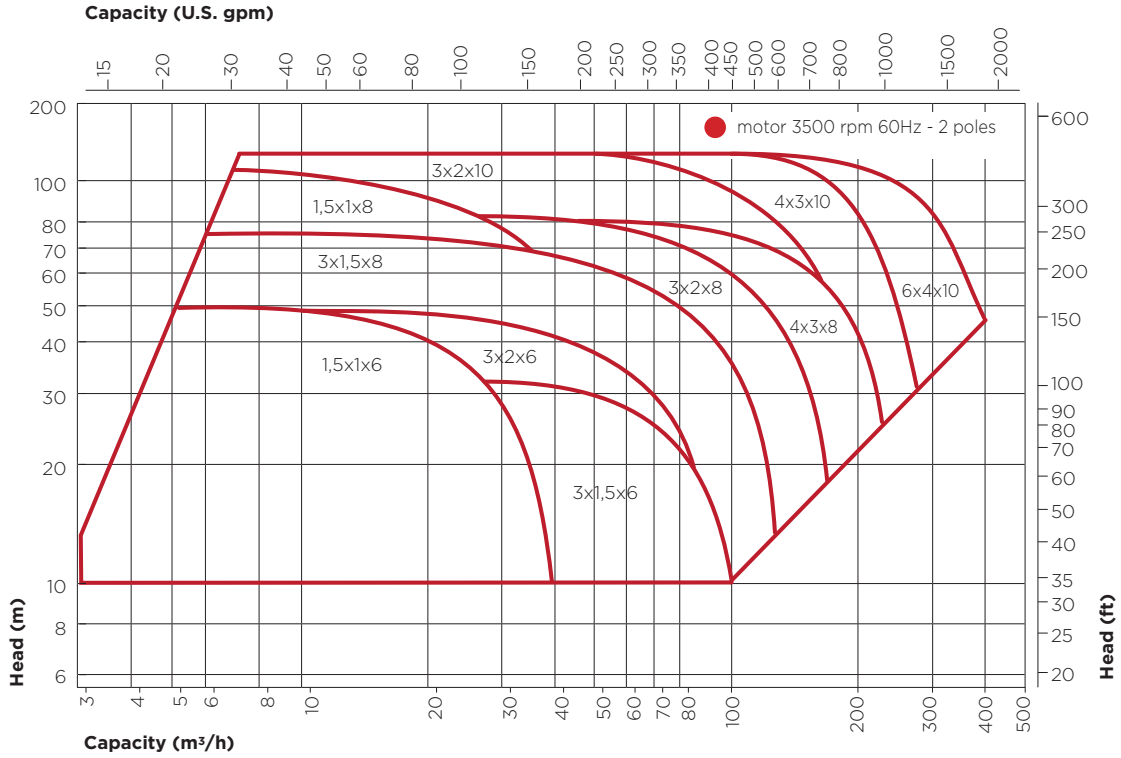

1750 - 1170 rpm

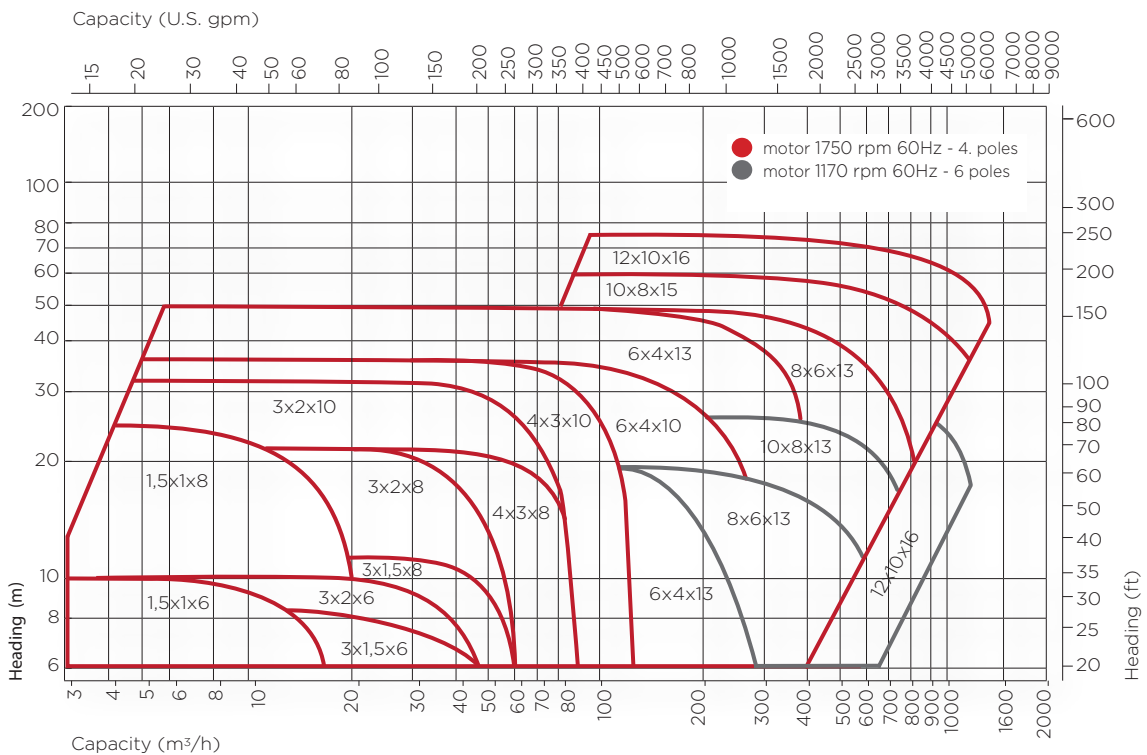

WHY CHOOSING A SATURN EVO PUMP ?

Summable into 4 significant details:

- the volute casing is made of only one piece guaranteeing a total robustness, shock-resistance and regular thickness.
- the blade shape of the impellers with augmented-energetical-efficiency three-dimensional development and less NPSH required. Blades are internally reinforced with carbon fiber.
- a new external system for even better performance of the pump: it is now possible to adjust the impeller position closer to the volute casing by relocating the shaft only.
- the feet and flanges are reinforced in kevlar

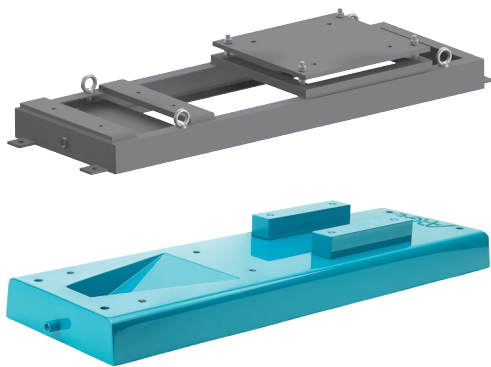

BASEPLATE

Made of carbon steel profiles, painted with anti-corrosion enamel and provided with a system to adjust the position of the motor to ease its alignment with the pump.

Also available in fiberglass: an alternative which offers high chemical resistance with no need for protective coating.

SEAL FLUSHING

Seals are usually flushed by the pumped liquid or by an external clean liquid if necessary. Single, double or cartridge models are available with different material combinations.

TR5 - TR8



BF8



MTR5-MTR8



CS8



CS8-F



MC8



INDUCER

Extra component to facilitate the hydrodynamic of the aspiring zone: it lowers the NPSH value, it reduces the fluid losses significantly. It can be installed if during the suction phase the pump meets unexcepted fluid turbulence and excessive vibrations.

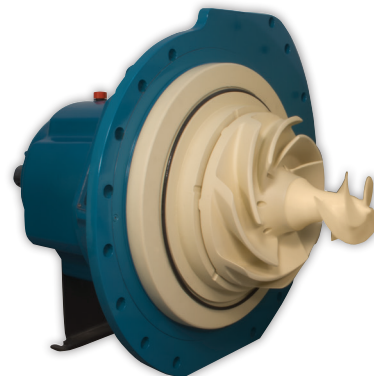

PRE-FILTER

Located in front of the pump and directly linked to inlet pipe flange, the pre-filter holds the liquid's rough impurities to avoid the pump to be damaged. Equipped with large basket and easy-to-clean. An obstruction detector with alarm signal can be added.

MAG-DRIVE &
MECH-SEALED
CENTRIFUGAL
PUMPS

PNEUMATIC
AODD &
METERING
PUMPS
PULSATION
DAMPENERS

SUBMERSIBLE
PUMPS



SELF-PRIMING
PUMPS

VERTICAL
SUMP PUMPS

ARGAL srl

Via Labirinto, 159 - 25125 BRESCIA - (Italy)
Phone +39 030 3507011 - fax +39 030 3507077
info@argal.it - www.argalpumps.com



cod. 01.2018 - EN