



Herramientales



Sistema de Herramientales

- I 02** Serie DBT
- I 03** Herramientas con Sistema HSK
- I 04** Sistema de Balanceo
- I 05** Índice
- I 06** Serie DHE
- I 10** Serie DSC
- I 17** Serie CPM
- I 19** Serie NPM
- I 21** DCS/DC/TC
- I 22** Serie Collet Chuck
- I 24** Serie SDC
- I 29** Serie GSK
- I 31** Serie DSK
- I 34** GERC
- I 37** Serie DST
- I 39** NPU
- I 40** Serie DTN
- I 42** TCA adaptador de machos
- I 43** TER adaptador para machos
- I 44** Aclopador lateral weldon
- I 46** Adaptador para fresado
- I 49** Serie Cabeza angular
- I 57** Serie FBH/B
- I 61** Serie TBC/FBC
- I 64** FBB
- I 65** DBC
- I 66** KMB
- I 67** SMB
- I 68** SMH
- I 69** Sistema Modular
- I 70** Adaptador modular
- I 72** Barra Extensión
- I 73** Barra de Reducción
- I 74** DAMPING PRO
- I 81** Otros



Serie DBT

Para maquinados a alta velocidad

Serie DBT

Sistema restringido de 2 caras de cara cónica y de vástago para una excelente rugosidad de la superficie y un acabado de alta calidad en cortes pesados a alta velocidad



➤ Sistema restringido de 2 caras: características

- Maquinado estable a alta velocidad
- Mejorada vida de la herramienta para máquinas de eje y herramienta de corte
- Prevención de la corrosión de porsion cono de husillo de la máquina y soporte de la herramienta por la vibración pesada del maquinado
- Garantizado para el maquinado más adecuado y de alta precisión

➤ Tipo BT

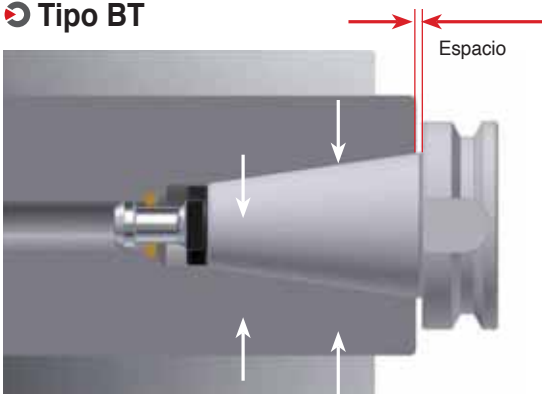

Brecha entre la sección transversal de un cabezal y un vástago
-La misma condición de sujeción que en un vástago de sujeción BT

➤ Tipo DBT

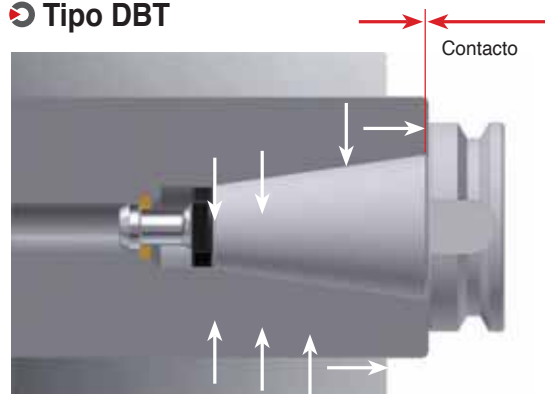

No hay brecha entre la sección transversal de un cabezal y un vástago
- mejor rugosidad superficial/mecanismo mejorado/ menos cracterización

➤ Mayor estabilidad y precisión

La estabilidad y la precisión aumentan debido al contacto cercano entre la cara cónica y el diámetro externo ancho de la brida en el vástago con husillo DBT que en el vástago BT

Porta	Cónico	Brida
BT30	Ø31.7	Ø46
BT40	Ø44.4	Ø63
BT50	Ø69.8	Ø100

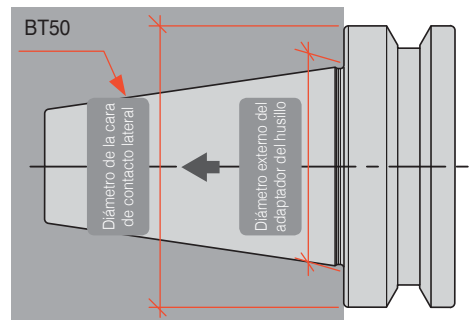

Diferencia entre la cara de contacto lateral y el diámetro externo

➤ Varios modelos

Para machos de roscar	Para fresado	Para fresado con fresa insertable	Cabeza Angular
 BT-DST	 BT-NPM	 BT-DHE	 BT-FMA
	 BT-KAG		



Herramientas con Sistema HSK

➤ Ventajas de los adaptadores HSK con presión en dos fases

El vástago cónico 7/24 para usos múltiples se ha señalado que su rendimiento es inadecuado en términos de repetibilidad, Rigidez conjunta y mecanizado a alta velocidad. Los inconvenientes de 7/24 vástagos cónicos se habían eliminado mediante el uso de dos nuevos contactos frontales

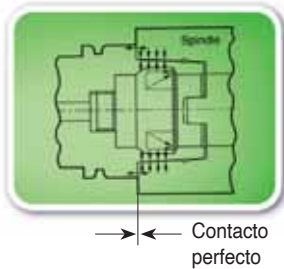

Deformación elástica de cónica hace la brida superficie estrechamente en contacto el husillo

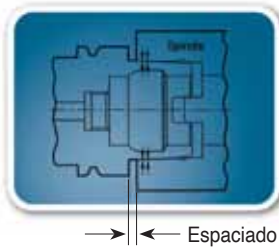

Conexión

Espaciado



Sistema HSK - sistema de contacto perfecto en dos superficies

➤ Excelente precisión de repetición y agotamiento

Como el cono del soporte se deformará elásticamente siguiendo el perfil de la forma del husillo, no hay excentricidad entre husillo y el otro. Además, debido al contacto perfecto entre la superficie de la brida del soporte y la cara del husillo, se dobla La resistencia del soporte es muy alta, lo que hace que la precisión radial y axial sea muy alta.

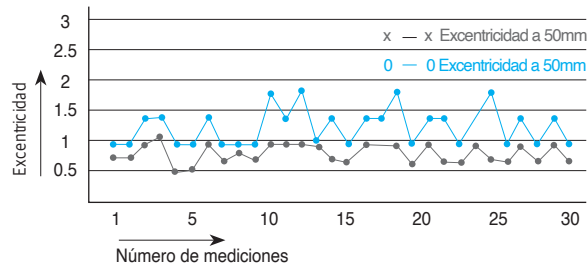
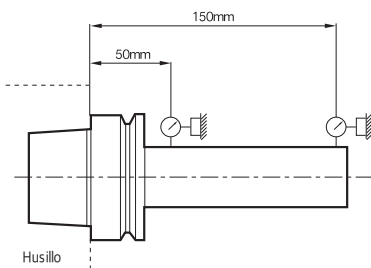

➤ Alta rigidez frente a la carga de flexión

HSK 63	BT 40

Sistema de balanceo

⦿ Desequilibrio

• Causa de desequilibrio

El desequilibrio se produce debido a la asimetría de las geometrías de las herramientas y desgaste del husillo

• Dificultades de desequilibrio

La vida útil de la herramienta es más corta, la rugosidad de la superficie inferior y el ruido son causados por Vibración durante la rotación y daños en el rodamiento del husillo.

• Necesidad de equilibrar

Es necesario equilibrar para evitar el desequilibrio para una mejor rugosidad de la superficie, precisión y vida útil de la herramienta

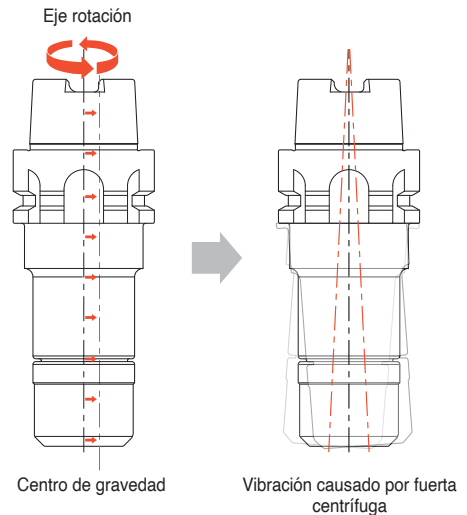

※ Un caso en el que el centro de gravedad de la herramienta. se desvía del eje de rotación

⦿ La precisión óptima a alta velocidad

- Sin flexión de la rotación debido a la carga balanceada, de alta precisión y rigidez se mantienen mucho tiempo.
- Balance Excelente ($\leq G1.0$ ó $0.5 \text{ g}\cdot\text{mm}/\text{kg}$)
- Excelente vida de la herramienta, el acabado superficial, la dimensión de la precisión y la productividad se puede realizar a gran velocidad.

⦿ Grado de balanceo estándar

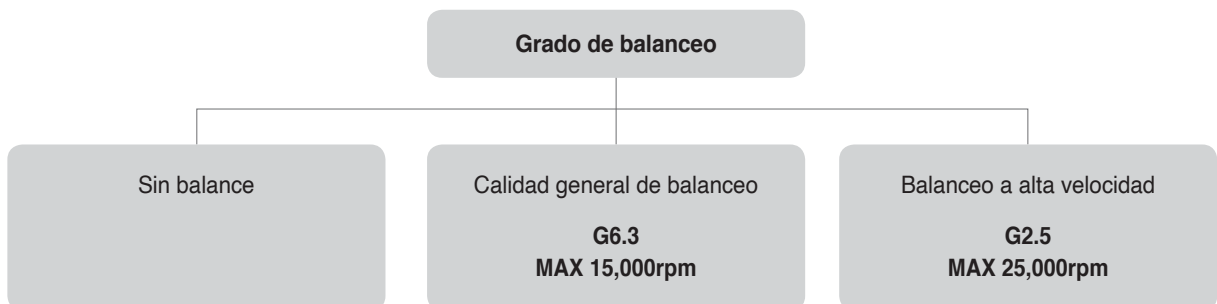

Distintas opciones de balanceo disponibles



<p>Adaptador hidráulico</p> <p>DHE</p>  <p>I 7</p>	<p>Adaptador ajustable por contracción térmica</p> <p>DSC</p>  <p>I 11</p>	<p>Adaptador Champion Milling Chuck</p> <p>CPM</p>  <p>I 18</p>	<p>Adaptador fresado</p> <p>NPM</p>  <p>I 20</p>
<p>Portapinzas ER</p> <p>SDC</p>  <p>I 24</p>	<p>Portapinzas ER</p> <p>SDC/S</p>  <p>I 28</p>	<p>Portapinzas ER para alta velocidad</p> <p>GSK</p>  <p>I 29</p>	<p>Portapinzas ER</p> <p>DSK</p>  <p>I 32</p>
<p>Adaptador portapinzas para roscado con machos a alta velocidad</p> <p>DST</p>  <p>I 38</p>	<p>Adaptador para taladrado</p> <p>NPU</p>  <p>I 39</p>	<p>Adaptador portapinzas para roscado con machos</p> <p>DTN</p>  <p>I 41</p>	<p>Adaptador con mango de apriete con weldon</p> <p>SLA</p>  <p>I 44</p>
<p>Adaptador para fresado</p> <p>FMA, FMC</p>  <p>I 46</p>	<p>Cabeza angular</p> <p>MAH</p>  <p>I 51</p>	<p>Cabeza angular</p> <p>HRAG</p>  <p>I 52</p>	<p>Cabeza angular</p> <p>KHU</p>  <p>I 53</p>
<p>Cabeza angular</p> <p>KAG</p>  <p>I 54</p>	<p>Cabeza angular</p> <p>KAH</p>  <p>I 55</p>	<p>Cabeza angular</p> <p>KAC</p>  <p>I 56</p>	<p>Herramienta mandrinado</p> <p>FBH/B</p>  <p>I 58</p>
<p>Herramienta mandrinado</p> <p>TBC, FBC</p>  <p>I 63</p>	<p>Herramienta mandrinado</p> <p>DBC</p>  <p>I 65</p>	<p>Herramienta mandrinado</p> <p>KMB</p>  <p>I 66</p>	<p>Herramienta mandrinado</p> <p>SMB</p>  <p>I 67</p>
<p>Herramienta mandrinado</p> <p>SMH</p>  <p>I 68</p>	<p>Adaptador sistema modular</p> <p>MD</p>  <p>I 70</p>	<p>Adaptador sistema modular, barra extensión</p> <p>EXT</p>  <p>I 72</p>	<p>Adaptador sistema modular, barra reducción</p> <p>RDC</p>  <p>I 73</p>
<p>DAMPING PRO</p> <p>FMA/FMC</p>  <p>I 76</p>			

El Chuck hidráulico para el mecanizado de mayor precisión debido a alta precisión y alta fuerza de abrazar

Serie DHE

- Diferentes aplicaciones: maquinado de moldes, partes de automóviles, piezas de precisión, etc
- Con una gran durabilidad, precisión y fuerza de cierre, no se cambian por un largo tiempo
- Elevada fuerz de fijación permite un maquinado estable sin fluctuaciones en la fuerza de sujeción



Sistema de codificación



Características

Su alta precisión alarga la vida útil de la herramienta debido a un menor desgaste y la cámara hidráulica aumenta la rugosidad superficial al disminuir las vibraciones

- Excentricidad: menos de 5 μm
- $L = 3 \times \text{ØD}$
- Mango: Tolerancia de $\text{ØD}: h6$



Estructura de sellado interno (Durabilidad)

- El sistema de sellado interno evita que el polvo, aceite de corte, lubricantes y virutas penetren en el portaherramientas
- Mantiene la fuerza de fijación y la precisión durante largo tiempo long time

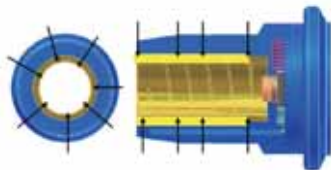

Su estructura de sujeción facilita la operación (Conveniente)

- Se puede cambiar fácilmente la herramienta con una llave de tuercas con mango en T
- Reduce la fatiga del trabajador
- Mejora la capacidad de la máquina



Agarre estable

El espacio entre el soporte y la herramienta se fija por presión hidráulica



Husillo	Grado	Rpm máximas
BT50, SK50, HSK100A	G6.3	10,000
BT40, SK40, HSK63A		15,000
BT30, HSK50A, SK30		20,000
HSK40A	-	25,000



BT-DHE

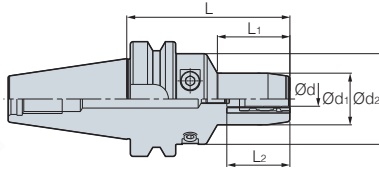

Fig. 1

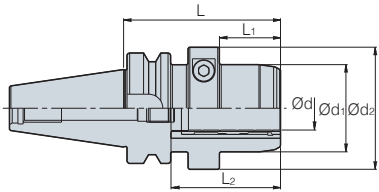

Fig. 2

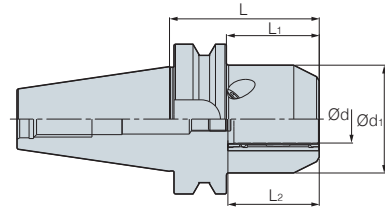
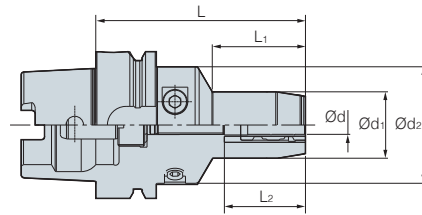

Fig. 3

Código	Ød	L	Ød ₁	Ød ₂	L ₁	L ₂	Tornillo de Ajuste	Fig.	kg
BT30 -									
DHE 6 - 65	6	65	29	45	33	30~39.8	M5	1	0.7
DHE 8 - 65	8	65	31	45	33	30~39.8	M5	1	0.7
DHE 10 - 65	10	65	32	45	34	35~44.8	M5	1	0.7
DHE 12 - 65	12	65	35	45	34	41~50.8	M5	1	0.7
DHE 14 - 90	14	90	36	45	40	43~52.8	M5	1	0.9
DHE 16 - 90	16	90	40	45	45	46~55.8	M5	1	1.0
DHE 18 - 90	18	90	42	45	40	49~58.8	M5	1	1.0
DHE 20 - 90	20	90	44	45	45	49~58.8	M5	1	1.1
BT40 -									
DHE 6 - 90	6	90	29	50	40	30~39.8	M5	1	1.4
140	6	140	29	50	40	30~39.8	M5	1	2.2
DHE 8 - 90	8	90	31	50	40	30~39.8	M5	1	1.4
140	8	140	31	50	40	30~39.8	M5	1	2.2
DHE 10 - 90	10	90	33	50	40	35~44.8	M5	1	1.5
140	10	140	33	50	40	35~44.8	M5	1	2.2
DHE 12 - 90	12	90	35	50	40	41~50.8	M10	1	1.5
140	12	140	35	50	40	41~50.8	M10	1	2.3
DHE 14 - 90	14	90	36	50	40	43~52.8	M10	1	1.5
140	14	140	36	50	40	43~52.8	M10	1	2.3
DHE 16 - 90	16	90	40	50	45	46~55.8	M10	1	1.5
140	16	140	40	50	45	46~55.8	M10	1	2.3
DHE 18 - 90	18	90	42	50	45	49~58.8	M10	1	1.5
140	18	140	42	50	45	49~58.8	M10	1	2.3
DHE 20 - 90	20	90	44	50	47	49~58.8	M10	1	1.5
140	20	140	44	50	47	49~58.8	M10	1	2.3
DHE 25 - 90	25	90	50	70	35	58~67.8	M16	2	1.9
DHE 32 - 90	32	90	63	80	35	58~67.8	M16	2	2.0
BT50 -									
DHE 6 - 90	6	90	29	50	34	30~39.8	M5	1	3.9
140	6	140	29	50	40	30~39.8	M5	1	4.5
DHE 8 - 90	8	90	31	50	34	30~39.8	M5	1	3.9
140	8	140	31	50	40	30~39.8	M5	1	4.5
DHE 10 - 90	10	90	33	50	34	35~44.8	M5	1	3.9
140	10	140	33	50	34	35~44.8	M5	1	4.5
DHE 12 - 90	12	90	35	50	34	41~50.8	M10	1	4.0
140	12	140	35	50	34	41~50.8	M10	1	4.6
DHE 14 - 90	14	90	36	50	34	43~52.8	M10	1	4.0
140	14	140	36	50	34	43~52.8	M10	1	4.6
DHE 16 - 90	16	90	40	50	34	46~55.8	M10	1	4.1
140	16	140	40	50	34	46~55.8	M10	1	4.7
DHE 18 - 90	18	90	42	50	40	49~58.8	M10	1	4.1
140	18	140	42	50	45	19~58.8	M10	1	4.7
DHE 20 - 90	20	90	44	50	34	49~58.8	M10	1	4.2
140	20	140	44	50	47	49~58.8	M10	1	4.7
DHE 25 - 90	25	90	66	-	52	58~67.8	M16	3	4.7
DHE 32 - 90	32	90	72	-	52	58~67.8	M16	3	4.8



HSK-DHE



(mm)

Código	Ød	L	Ød ₁	Ød ₂	L ₁	L ₂	Tornillo de Ajuste		
HSK63A -	DHE 6 - 75	6	75	29	50	34	30~39.8	M5	1.0
	DHE 8 - 75	8	75	31	50	34	30~39.8	M5	1.0
	DHE 10 - 85	10	85	33	50	40	35~44.8	M5	1.2
	DHE 12 - 90	12	90	35	50	40	41~50.8	M5	1.2
	DHE 16 - 95	16	95	40	50	45	46~55.8	M10	1.3
	DHE 20 - 100	20	100	44	50	50	49~58.8	M10	1.4
	150	20	150	44	50	50	49~58.8	M10	2.0
HSK100A -	DHE 20 - 105	20	105	44	50	50	49~58.8	M10	2.8
	DHE 25 - 115	25	115	50	63	62	58~67.8	M16	3.3
	DHE 32 - 115	32	115	63	75	62	58~67.8	M16	3.8

• L₂ : máxima longitud de inserción (mín-máx) • Sistema de lubricación interno es opcional

Boquilla DHC (Tipo general)

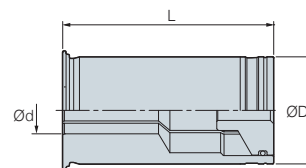

(mm)

Código	ØD	Ød	L
DHC12 - 3, 4, 5, 6, 8	12	3, 4, 5, 6, 8	47
DHC20 - 3, 4, 5, 6, 8, 10, 12, 14, 16	20	3, 4, 5, 6, 8, 10, 12, 14, 16	52
DHC32 - 6, 8, 10, 12, 14, 16, 18, 20, 25	32	6, 8, 10, 12, 14, 16, 18, 20, 25	63



Boquilla DHC (Para precisión)

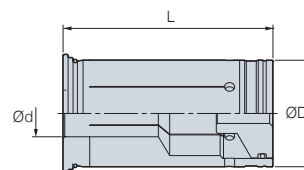

(mm)

Código	ØD	Ød	L
DHC12 - 3(P), 4(P), 5(P), 6(P), 8(P)	12	3, 4, 5, 6, 8	47
DHC20 - 3(P), 4(P), 5(P), 6(P), 8(P), 10(P), 12(P), 14(P), 16(P)	20	3, 4, 5, 6, 8, 10, 12, 14, 16	52
DHC32 - 6(P), 8(P), 10(P), 12(P), 14(P), 16(P), 18(P), 20(P), 25(P)	32	6, 8, 10, 12, 14, 16, 18, 20, 25	63

Boquilla DHJ (Tipo refrigeración Jet)

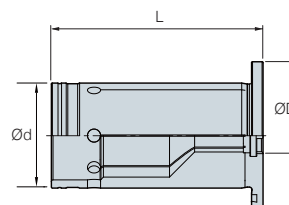

(mm)

Código	ØD	Ød	L
DHJ20 - 6, 8, 10, 12, 14, 16	20	6, 8, 10, 12, 14, 16	50

Partes

Piezas de Refacción					
Chuck		Tornillo Brida	Llave	Chuck	Tornillo de Ajuste
Tipo				Tipo	
BT30/SK30/HSK50	DHE 6, 8, 10, 12	DHE-M8 (C)	DHETW-4	DHE 6, 8, 10	DHE-M5 (ADJ)
	DHE 14, 16, 18, 20	DHE-M10 (C)	DHETW-5		
BT40/BT50/SK40/SK50 HSK63A/HSK100A	DHE 6, 8, 10, 12, 14, 16, 18, 20	DHE-M10 (C)	DHETW-5	DHE 12, 14, 16, 18, 20	DHE-M10 (ADJ)
	DHE 25, 32	DHE-M12 (C)	DHETW-6	DHE 25, 32	DHE-M16 (ADJ)

El diseño compacto de Chuck de encogimiento para ultra alta velocidad y alta precisión

DSC

- Uso de acero especialmente tratado al calor.
- Mecanizado y sujeción de alta precisión.
- Mayor precisión y mayor vida útil de la herramienta debido a un voladizo minimizado al mecanizar ranuras profundas
- Diámetro de vástago aplicable: Ø3-Ø32



Sistema de codificación

BT50 - DSC 6 - S - 165 - S					
Husillo	Tipo de adaptador	Diámetro de herramienta	Tipo	Longitud	Especial
BT, HSK, SK, ST, CS, CM	DSC: Adaptador ajustable por contracción térmica SLK: Boquilla de dos piezas		S: Fino M: Tamaño medio Sin marca: general		S: Tipo curvo Sin marca: general

Tipo mono curvo

- DSC integral con alta precisión y balanceo
- Diseño largo pero estable



Alta fuerza de corte

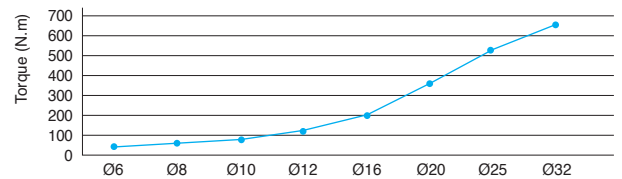

- Fuerza de amarre un 30% más fuerte
- Excentricidad (≤ 0.003 mm)
- Alto poder de transmisión de la fuerza de amarre por el círculo interno

Diseño simétrico

- Alta fuerza de amarre



Adaptador por encogimiento

Fijar la holgura entre el soporte y Herramienta por contracción térmica.

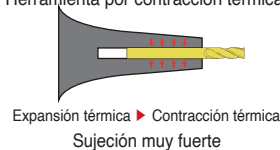

Adaptador con boquilla

Fijar la herramienta por elasticidad de pinza.



Adaptador de una pieza

Figura	Precision
<p>Estrechamiento 3° Grosor</p>	<p>Excentricidad 3 µm</p>
<p>Tipo fino 1.5t</p> <p>Tipo medio 2~4.5t</p>	

Adaptador de dos piezas

Figura	Precision
<p>Porta herramienta Boquilla Tornillo Estrechamiento 3° Grosor</p>	<p>Excentricidad 5 µm</p>
<p>Tipo fino 1.5t</p> <p>Tipo medio 2~3.5t</p>	



BT-DSC

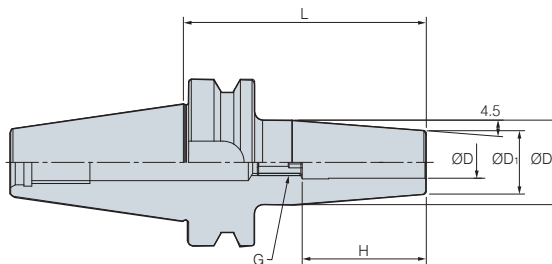

(mm)

Código	ØD	L	ØD ₁	ØD ₂	H	G	kg	Rpm máximas	
BT30 -	DSC3 - 60	3	60	11	18.5	82	-	0.6	25,000
	DSC4 - 60	4	60	13	20.5	82	-	0.6	25,000
BT40 -	DSC6 - 90	6	90	21	27	36	M5	1.2	20,000
	120	6	120	21	27	36	M5	1.2	20,000
	160	6	160	21	27	36	M5	1.4	20,000
	DSC8 - 90	8	90	21	27	36	M5	1.2	20,000
	120	8	120	21	27	36	M5	1.2	20,000
	160	8	160	21	27	36	M5	1.4	20,000
	DSC10 - 90	10	90	24	32	42	M8	1.2	20,000
	120	10	120	24	32	42	M8	1.2	20,000
	160	10	160	24	32	42	M8	1.6	20,000
	DSC12 - 90	12	90	24	32	47	M8	1.2	20,000
	120	12	120	24	32	47	M8	1.2	20,000
	160	12	160	24	32	47	M8	1.6	20,000
	DSC16 - 90	16	90	27	34	50	M12	1.3	20,000
	120	16	120	27	34	50	M12	1.3	20,000
	160	16	160	27	34	50	M12	1.7	20,000
	DSC20 - 90	20	90	33	42	52	M12	1.3	20,000
120	20	120	33	42	52	M12	1.5	20,000	
160	20	160	33	42	52	M12	2.1	20,000	

Tornillo de Ajuste I 16

• Sistema de lubricación interno es opcional

BT-DSC/M

Tipo de una pieza con curvatura

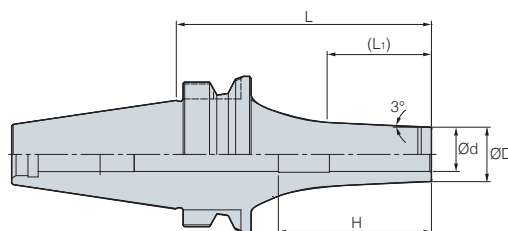

(mm)

Código	ØD	L	L ₁	ØD ₁	ØC ₁	H	G	kg	Rpm máximas	
BT30 -	DSC3M - 75S	3	75	29.8	8	25	97	-	0.6	25,000
	DSC4M - 75S	4	75	31.8	10	25	97	-	0.6	25,000
	DSC6M - 75S	6	75	28.9	12	30	97	-	0.6	25,000
	DSC8M - 75S	8	75	28.9	14	32	97	-	0.6	25,000
	DSC10M - 75S	10	75	30.66	16	32	45	-	0.6	25,000

• No requiere tornillo de ajuste • Sistema de lubricación interno es opcional



BT-DSC/M

Tipo de una pieza

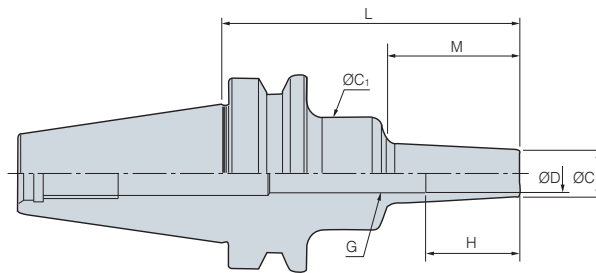

(mm)

Código	ØD	L	ØD ₁	ØC ₁	M	H		
BT40 -	DSC6M - 95	6	95	10	26	42	18	1.2
	120	6	120	10	26	67	18	1.2
	160	6	160	10	36	97	18	1.5
	DSC8M - 95	8	95	13	36	42	24	1.2
	120	8	120	13	36	67	24	1.2
	160	8	160	13	36	97	24	1.5
	DSC10M - 95	10	95	16	36	42	30	1.2
	120	10	120	16	36	67	30	1.2
	160	10	160	16	36	97	30	1.5
	DSC12M - 95	12	95	19	36	42	30	1.2
	120	12	120	19	36	67	30	1.2
	160	12	160	19	36	97	30	1.5
	DSC16M - 95	16	95	24	50	42	32	1.2
	120	16	120	24	50	67	32	1.2
	160	16	160	24	50	97	32	1.5
DSC20M - 95	20	95	29	50	42	40	1.2	
120	20	120	29	50	67	40	1.2	
160	20	160	29	50	97	40	1.5	
BT50 -	DSC6M - 110	6	110	10	26	42	18	3.5
	160	6	160	10	36	97	18	4
	DSC8M - 110	8	110	13	36	42	24	3.5
	160	8	160	13	36	97	24	4
	DSC10M - 110	10	110	16	36	42	30	3.5
	160	10	160	16	36	97	30	4
	DSC12M - 110	12	110	19	36	42	30	3.5
	160	12	160	19	50	97	30	4
	DSC16M - 110	16	110	24	50	42	32	3.5
	160	16	160	24	50	97	32	4
	DSC20M - 110	20	110	29	50	42	40	3.5
	160	20	160	29	50	97	40	4

 Tornillo de Ajuste 116

• Sistema de lubricación interno es opcional



BT-DSC/S

Tipo de una pieza fino

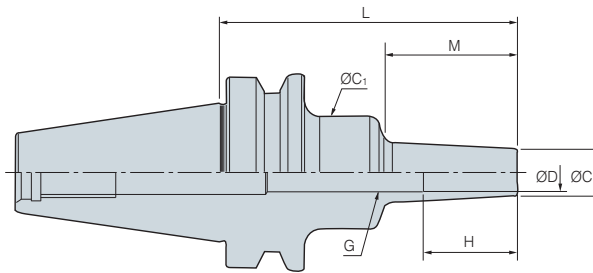

(mm)

Código	ØD	L	ØD ₁	ØC ₁	M	H	
BT30 -	DSC6S - 60	6	60	9	20	22	18
	80	6	80	9	20	42	18
	120	6	120	9	25	67	18
BT40 -	DSC6S - 95	6	95	9	26	42	18
	120	6	120	9	26	67	18
	160	6	160	9	36	97	18
	DSC8S - 95	8	95	11	36	42	24
	120	8	120	11	36	67	24
	160	8	160	11	36	97	24
	DSC10S - 95	10	95	13	36	42	30
	120	10	120	13	36	67	30
	160	10	160	13	36	97	30
	DSC12S - 95	12	95	15	36	42	30
	120	12	120	15	36	67	30
	160	12	160	15	36	97	30
BT50 -	DSC6S - 110	6	110	9	26	42	18
	160	6	160	9	36	97	18
	DSC8S - 110	8	110	11	36	42	24
	160	8	160	11	36	97	24
	DSC10S - 110	10	110	13	36	42	30
	160	10	160	13	36	97	30
	DSC12S - 110	12	110	15	36	42	30
	160	12	160	15	36	97	30

• No requiere tornillo de ajuste • Sistema de lubricación interno disponible



BT-SLK

Tipo de dos piezas

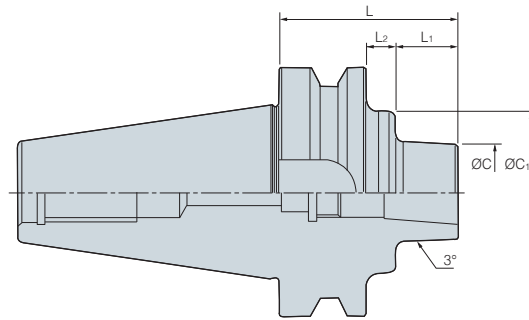

(mm)

	Código	L	ØC	L ₁	L ₂	ØC ₁
BT30 -	SLK12 - 35	35	38	13	-	-
BT40 -	SLK12 - 45	45	38	18	-	-
	45F	45	41	18	-	-
	75	75	38	48	-	-
	75F	75	41	48	-	-
	135F	135	41	108	-	-
BT50 -	SLK12 - 75	75	38	25	12	65
	75F	75	41	25	12	65
	105F	105	41	55	12	65
	135F	135	41	85	12	65
	225	225	38	150	37	65
	315	315	38	150	127	90

Tornillo de Ajuste I16

• Sistema de lubricación interno disponible

• Se requiere perno de contención para el modelo BT30-SLK12-35



CS/CM

Tipo de dos piezas

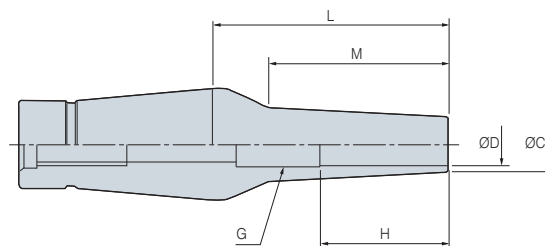
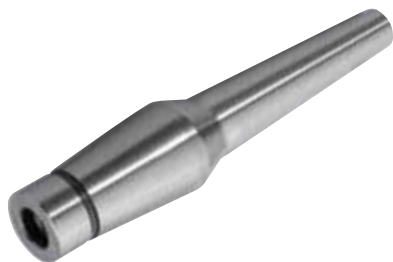

(mm)

Código			ØD	ØC	L	M	H
CS12 -	6 -	36	6	9	35	22	18
		55	6	9	55	42	18
		80	6	9	80	67	18
		110	6	9	110	97	18
	8 -	35	8	11	35	22	24
		55	8	11	55	42	24
		80	8	11	80	67	24
		110	8	11	110	97	24
	10 -	35	10	13	35	22	30
		55	10	13	55	42	30
		80	10	13	80	67	30
		110	10	13	110	97	30
12 -	35	12	15	35	22	30	
	55	12	15	55	42	30	
	80	12	15	80	67	30	
	110	12	15	110	97	30	

• No requiere tornillo de ajuste • Sistema de lubricación interno disponible

(mm)

Código			ØD	ØC	L	M	H
CM12 -	6 -	35	6	12	35	22	18
		55	6	12	55	42	18
		80	6	12	80	67	18
	8 -	35	8	14	35	22	24
		55	8	14	55	42	24
		80	8	14	80	67	24
	10 -	35	10	16	35	22	30
		55	10	16	55	42	30
		80	10	16	80	67	30
	12 -	35	12	20	35	22	30
		55	12	20	55	42	30
		80	12	20	80	67	30

➔ Tornillo de Ajuste 116

• Sistema de lubricación interno disponible



HSK-DSC/M

Tipo de una pieza

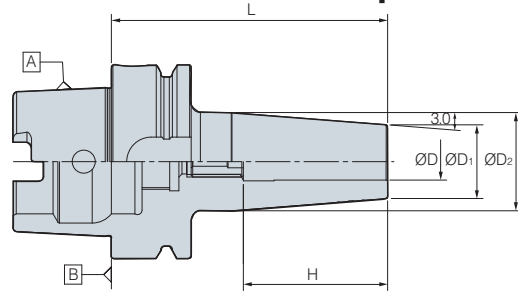

(mm)

Código	ØD	L	ØD ₁	ØC ₁	M	H	
HSK63A -	DSC6M - 95	6	95	10	26	42	18
	DSC8M - 95	8	95	13	36	42	24
	DSC10M - 120	10	120	16	36	67	30
	DSC12M - 120	12	120	19	36	67	30
	DSC16M - 120	16	120	24	50	67	32

• No requiere tornillo de ajuste • Sistema de lubricación interno es opcional

Partes

Piezas de Refacción										
Tipo	DSC6	DSC8	DSC10	DSC12	DSC14	DSC16	DSC18	DSC20	DSC25	DSC32
Tornillo de Ajuste 	M520C		M820C						M1230C	



Champion milling chuck

CPM

- Mejora la vida útil de la herramienta al bloquear el polvo y las fugas de lubricante Con perfecta estructura de sellado en junta tórica y tuerca.
- Disponible a través del sistema de refrigerante con juego de CTC
- RegulaEl regulador de longitud está insertado en el CPM, el usuario puede ajustar la longitud convenientemente



➤ Sistema de codificación



➤ Prevención de fugas de grasa y polvo.

CPM tiene una junta tórica en las tuercas para absorber la vibración de corte para Operación estable y evita la entrada de escombros.

Contacto facial para maquinado estable y prueba de polvo.

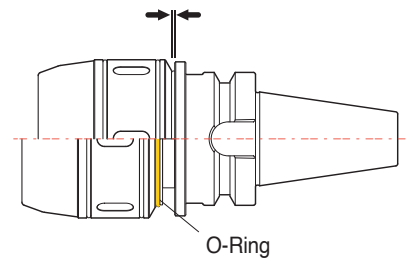

➤ Correlación de fugas de aceite y vida útil de la herramienta

Aumento evidente de la vida útil de la herramienta después de aplicar el sistema a prueba de polvo.

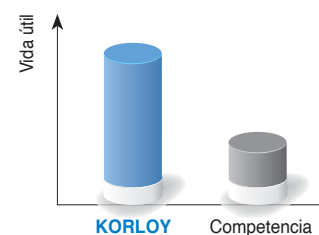
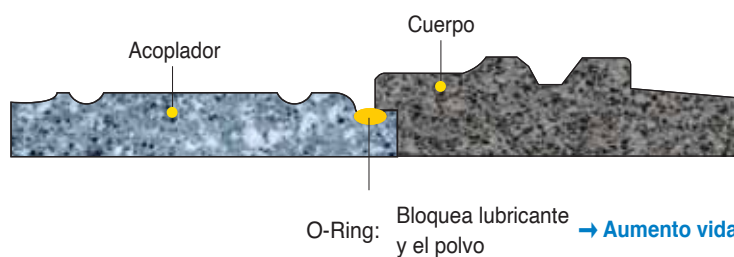

➔ Aumento vida herramienta



BT-CPM

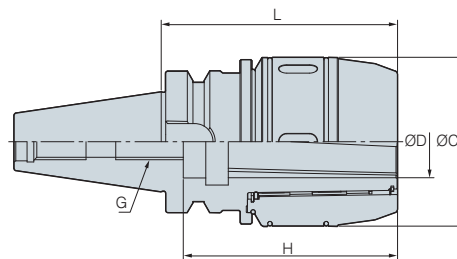

(mm)

Código	ØD	L	ØC	H	G	Boquilla	
BT30 - CPM20 - 80	20	80	54	80	M16	DC20, DSC20	1.1
BT40 - CPM20 - 90	20	90	54	80	M16	DC20, DSC20	2.3
CPM32 - 90	32	90	75	85	M16	DC32, DCS32	2.8
105	32	105	75	95	M16	DC32, DCS32	2.9
BT50 - CPM32 - 105	32	105	75	95	M24	DC32, DCS32	5.0
135	32	135	75	95	M24	DC32, DCS32	5.8
165	32	165	75	95	M24	DC32, DCS32	6.8

• Conjuntos disponibles por encargo • Sistema de lubricación interno es opcional



Portaherramientas de fresado para corte medio con durabilidad mejorada debido a su gran sujeción y a la prevención del polvo

NPM

- Sujeción fuerte de más de 500kgfm (En base NPM42)
- Funcion DUST BLOCK para bloqueo de sustancias nocivas
- refrigerante Jet disponible
- Precision Alta precisión dentro de 15 a L / D = 3
- Diámetro de vástago aplicable: D6-42



➤ Sistema de codificación

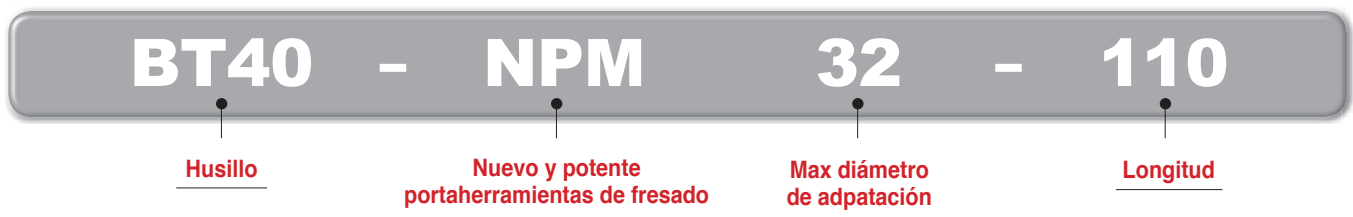

➤ Mejorada durabilidad, su diseño evita el ingreso de polvo, virutas, etc

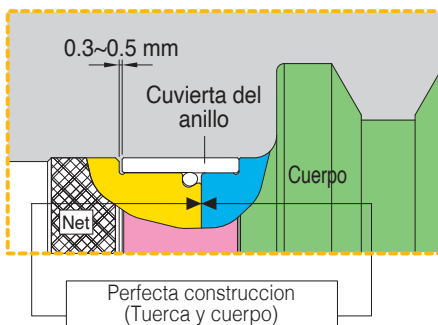

- Anillo de retención en la apertura de la boquilla
- evitando que el polvo y las virutas se introduzcan en el adaptador

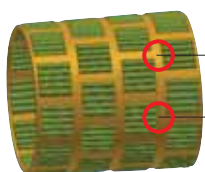

- Placa de retención
- Rodamientos tipo Aguja

- Cojinete de acero de diseño especial para evitar roturas
- Sujeción fuerte mediante propagación de la fuerza

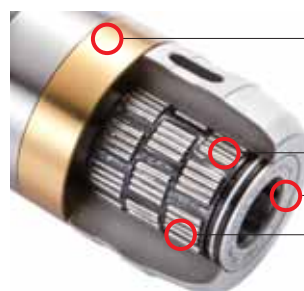

Rodamientos tipo aguja

➤ Mecanizado estable desde pesado a fino

Un contacto frontal perfecto y su gran fuerza de sujeción intensifican la fuerza de corte y la absorción de vibraciones



Para mecanizado desde fresado pesado a acabado fino



BT-NPM

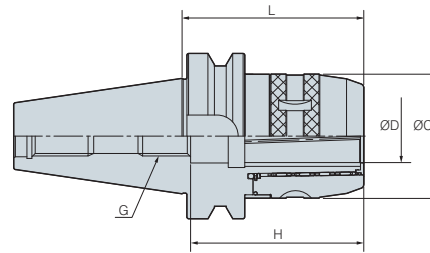

(mm)

Código	ØD	L	ØC	H	G	Boquilla			
BT30 - NPM20 - 85	20	85	54	85	M16	DC20, DSC20	1.1		
BT40 -	85	85	54	85	M16	DC20, DSC20	2.3		
	100	100	54	85	M16	DC20, DSC20	2.3		
	NPM25 - 85	25	85	61	M16	DC25, DSC25	2.5		
NPM32 - 90	32	90	75	87	M16	DC32, DCS32	2.8		
	110	110	75	95	M16	DC32, DCS32	2.9		
	135	135	75	95	M16	DC32, DCS32	3.5		
BT50 -	NPM20 - 95	20	95	54	85	M24	DC20, DSC20	4.3	
	125	20	125	54	85	M24	DC20, DSC20	4.8	
	165	20	165	54	85	M24	DC20, DSC20	5.3	
	NPM32 - 110	32	110	75	105	M24	DC32, DCS32	5.0	
		135	32	135	75	105	M24	DC32, DCS32	5.8
		165	32	165	75	105	M24	DC32, DCS32	6.8
	NPM42 - 110	42	110	90	125	M24	DC42, DCS42	5.4	
		135	42	135	90	125	M24	DC42, DCS42	6.6
		165	42	165	90	125	M24	DC42, DCS42	8.0

 Piezas de refacción 121

• Sistema de lubricación interno es opcional

• En el caso de $L \leq 90$, se recomiendan adaptadores con más de 90 mm para corte medio con tapa corta

HSK-NPM

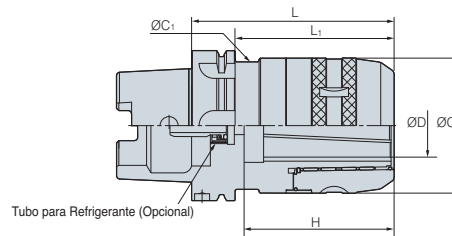



(mm)

Código	ØD	L	L ₁	ØC	Boquilla		
HSK63A -	NPM20 - 100	20	95	54	75	DC20, DSC20	1.1
	NPM32 - 120	42	135	90	90	DC42, DCS42	6.6
HSK100A -	NPM32 - 130	42	165	90	90	DC42, DCS42	8.0

 Piezas de refacción 121

• Sistema de lubricación interno es opcional

Partes

División	Piezas de Refacción		
	Opcional		
	Boquilla	Llave	Sistema de lubricación interno
Tipo			
NPM20	DC20, DCS20	57-60	CTC20-20
NPM32	DC32, DCS32	75-79	CTC32-32
NPM42	DC42, DCS42	92-96	CTC42-42



DCS Boquilla recta

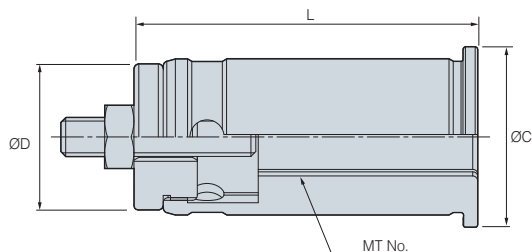

Código	ØD	Ød	ØC	L	kg
DCS20 - 6, 8, 10, 12, 16	20	6, 8, 10, 12, 16	26	55	0.2
DCS25 - 6, 8, 10, 12, 16, 20	25	6, 8, 10, 12, 16, 20	29	66.5	0.3
DCS32 - 6, 8, 10, 12, 14, 16, 19, 20, 25	32	6, 8, 10, 12, 14, 16, 19, 20, 25	38	70	0.4
DCS42 - 6, 8, 10, 12, 16, 20, 25, 32	42	6, 8, 10, 12, 16, 20, 25, 32	48	75	0.7

DC Boquilla recta

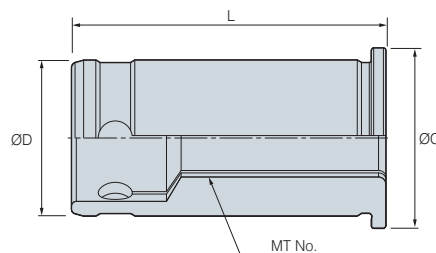

Código	ØD	Ød	ØC	L	kg
DC20 - 6, 8, 10, 12, 14, 16	20	6, 8, 10, 12, 14, 16	26	55	0.2
DC25 - 6, 8, 10, 12, 16, 20	25	6, 8, 10, 12, 16, 20	29	61.5	0.3
DC32 - 6, 8, 10, 12, 14, 16, 19, 20, 25	32	6, 8, 10, 12, 14, 16, 19, 20, 25	38	70	0.4
DC42 - 6, 8, 10, 12, 16, 20, 25, 32	42	6, 8, 10, 12, 16, 20, 25, 32	48	75	0.7

TC Boquilla en ángulo

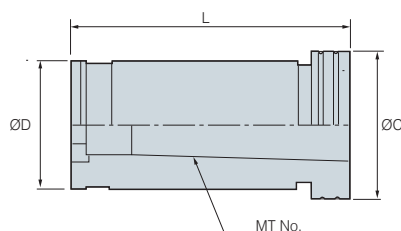

Código	MT No.	ØD	ØC	L
TC20 - 1	MT1	20	26	60
TC20 - 2	MT2	20	26	72
TC25 - 1	MT1	25	32	60
TC25 - 2	MT2	25	32	72
TC32 - 1	MT1	32	38	60
TC32 - 2	MT2	32	38	72

Código	MT No.	ØD	ØC	L
TC32 - 3	MT3	32	38	90
TC42 - 1	MT1	42	48	60
TC42 - 2	MT2	42	48	72
TC42 - 3	MT3	42	48	90
TC42 - 4	MT4	42	48	112.5

Serie Collet Chuck

- Alta precisión y gran fuerza de cierre
- Conveniente para el cambio de herramienta
- Diversidad de modelos
- Diámetro del Chuck $\varnothing 1.0\sim\varnothing 26.0\text{mm}$



Series Collet Chuck

Portapinzas ER	Portapinzas ER de alta velocidad	Portapinzas ER de ultra alta velocidad
		
<p>SDC/P</p> <ul style="list-style-type: none"> - Diam. Max del Portapinzas ER $\varnothing 26.0\text{mm}$ - Para taladrado, fresado con fresas enterizas y escariado 	<p>DSK</p> <ul style="list-style-type: none"> - Diam. Max del Portapinzas ER $\varnothing 20.0\text{mm}$ - Balanceado a G6.3 - Revoluciones Max.: 15,000rpm 	<p>GSK</p> <ul style="list-style-type: none"> - Diam. Max del Portapinzas ER $\varnothing 25.0\text{mm}$ - Balanceado a G2.5 - Revoluciones Max.: 25,000rpm

Pinza de alta precisión

- Tipo precisión: $5\ \mu\text{m}$ (GER-B)
- Tipo alta precisión: $2\ \mu\text{m}$ (GER-HP)
- Tipo refrigeración interior



- Tipo precisión
- Tipo alta precisión



- Tipo refrigeración interior



Portapinzas ER

SDC/P

- Adaptador boquilla ER, tipo estandar para maquinado general
- Diámetros aplicables: Ø1.0~Ø26.0

➤ **Boquilla de primera clase (Hecha en Suiza 🇨🇭)**



Boquillas de fácil acoplaje



Herramientas endurecidas con tratamiento especial



For SDC/P
(Para maquinado general)



Boquilla para alta velocidad

DSK

- Disponible para maquinado a max.15,000 RPM y balanceo de G6.3
- Vibración de la herramienta minimizada durante el funcionamiento utilizando una boquilla 8°
- La tuerca de alta precisión hecha en suiza mejora la estabilidad
- Diámetro de vástago aplicable: Ø1.8~Ø25



Tipo estandar & tipo precision	Designacion	Adaptador	Max a adaptar	Excentricidad
	HC6-Ød	10.5	6.0	Estándar Tipo 5µm
	HC10-Ød	15.5	10.0	
	HC13-Ød	20.1	13.0	
	HC16-Ød	24.6	16.0	Precision Tipo 3µm
	HC20-Ød	29.1	20.0	
	HC25-Ød	35.6	25.0	

Boquilla HC a 8°



Vibracion minimizada

Adaptador fino de super velocidad

GSK

- Disponible para maquinado a max.25,000 RPM y balanceo de G6.3
- Mayor productividad gracias al mecanizado de alta velocidad.
- Vibración minimizada de la herramienta durante el funcionamiento mediante el uso de boquilla 8°
- La tuerca de alta precisión hecha en Suiza mejora la estabilidad al presionar el collar uniformemente
- Diámetro del vástago aplicable: Ø1.8~Ø25



➤ **Diseño original**

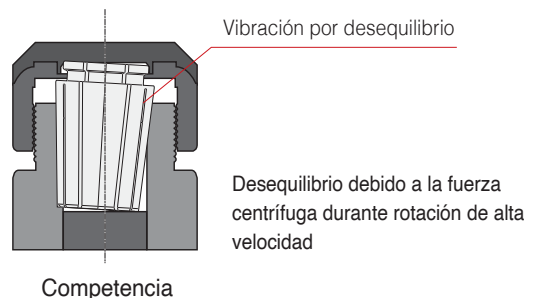
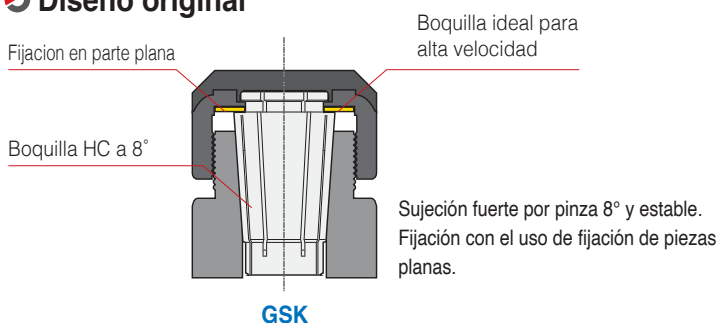

BT-SDC/P

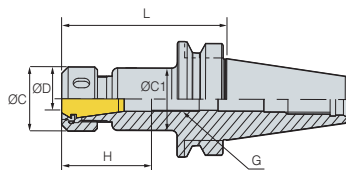

Fig. 1

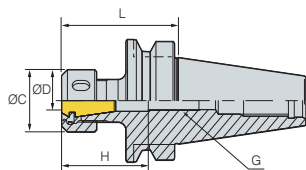

Fig. 2

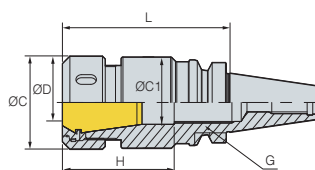

Fig. 3

(mm)

Código	ØD	L	H	Portapinzas ER / rango	G	ØC	ØC ₁	Fig.	
BT30 -	SDC7P - 70	1.0~7.0	70	33	GERC11/0.5	M7	18	17	1
	100	1.0~7.0	100	33	GERC11/0.5	M7	18	17	1
	SDC10P - 50	1.0~10.0	50	44.5	GERC16/1.0	M10	32	-	2
	70	1.0~10.0	70	44.5	GERC16/1.0	M10	32	31	1
	100	1.0~10.0	100	44.5	GERC16/1.0	M10	32	31	1
	SDC13P - 50	1.0~13.0	50	49	GERC20/1.0	M7	35	-	2
	70	1.0~13.0	70	49	GERC20/1.0	M13	35	34	1
	100	1.0~13.0	100	49	GERC20/1.0	M13	35	34	1
	SDC16P - 50	1.0~16.0	50	50	GERC25/1.0	M7	42	-	2
	70	1.0~16.0	70	50	GERC25/1.0	M18	42	41	1
	100	1.0~16.0	100	50	GERC25/1.0	M18	42	41	1
	SDC20P - 60	1.0~20.0	60	60	GERC32/1.0	M7	50	-	2
90	1.0~20.0	90	60	GERC32/1.0	M22	50	49	3	
120	1.0~20.0	120	60	GERC32/1.0	M22	50	49	3	
BT40 -	SDC7P - 70	1.0~7.0	70	33	GERC11/0.5	M7	18	17	1
	90	1.0~7.0	90	33	GERC11/0.5	M7	18	17	1
	130	1.0~7.0	130	33	GERC11/0.5	M7	18	17	1
	SDC10P - 70	1.0~10.0	70	44.5	GERC16/1.0	M10	32	31	1
	90	1.0~10.0	90	44.5	GERC16/1.0	M10	32	31	1
	130	1.0~10.0	130	44.5	GERC16/1.0	M10	32	31	1
	SDC13P - 70	1.0~13.0	70	49	GERC20/1.0	M13	35	34	1
	90	1.0~13.0	90	49	GERC20/1.0	M13	35	34	1
	130	1.0~13.0	130	49	GERC20/1.0	M13	35	34	1
	150	1.0~13.0	150	49	GERC20/1.0	M13	35	34	1
	SDC16P - 70	1.0~16.0	70	50	GERC25/1.0	M18	42	41	1
	90	1.0~16.0	90	50	GERC25/1.0	M18	42	41	1
	130	1.0~16.0	130	50	GERC25/1.0	M18	42	41	1
	SDC20P - 70	1.0~20.0	70	60	GERC32/1.0	M22	50	-	2
	90	1.0~20.0	90	60	GERC32/1.0	M22	50	49	1
	130	1.0~20.0	130	60	GERC32/1.0	M22	50	49	1
	150	1.0~20.0	150	60	GERC32/1.0	M22	50	49	1
	SDC26P - 90	3.0~26.0	90	71	GERC40/1.0	M28	63	62	1

⊗ Piezas de refacción 126

• Sistema de lubricación interno es opcional

• Seleccione el portapinzas correcto para herramientas con refrigeración interior



BT-SDC/P

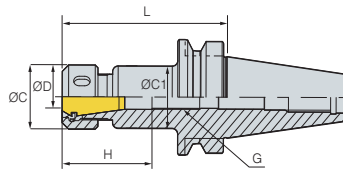

Fig. 1

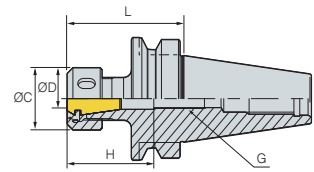

Fig. 2

Código		ØD	L	H	Portapinzas ER / rango	G	ØC	ØC ₁	Fig.
BT50 -	SDC10P - 100	1.0~10.0	100	44.5	GERC16/1.0	M10	32	31	1
	120	1.0~10.0	120	44.5	GERC16/1.0	M10	32	31	1
	160	1.0~10.0	160	44.5	GERC16/1.0	M10	32	31	1
	SDC13P - 100	1.0~13.0	100	49	GERC20/1.0	M13	35	34	1
	130	1.0~13.0	130	49	GERC20/1.0	M13	35	34	1
	160	1.0~13.0	160	49	GERC20/1.0	M13	35	34	1
	180	1.0~13.0	180	49	GERC20/1.0	M13	35	34	1
	SDC16P - 100	1.0~16.0	100	50	GERC25/1.0	M18	42	41	1
	160	1.0~16.0	160	50	GERC25/1.0	M18	42	41	1
	SDC20P - 70	1.0~20.0	70	60	GERC32/1.0	M22	50	-	2
	100	1.0~20.0	100	60	GERC32/1.0	M22	50	49	1
	130	1.0~20.0	130	60	GERC32/1.0	M22	50	49	1
	160	1.0~20.0	160	60	GERC32/1.0	M22	50	49	1
	180	1.0~20.0	180	60	GERC32/1.0	M22	50	49	1
	SDC26P - 160	3.0~26.0	160	71	GERC40/1.0	M28	63	62	1

(mm)

➔ Piezas de refacción 126

• Sistema de lubricación interno es opcional

• Seleccione el portapinzas correcto para herramientas con refrigeración interior



HSK-SDC/P

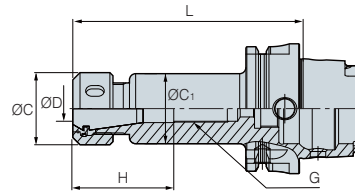

(mm)

Código	ØD	L	H	Portapinzas ER / rango	G	ØC	ØC ₁	
HSK63A -	SDC10P - 100	1.0~10.0	100	44.5	GER16/1.0	M10	32	31
	SDC13P - 100	1.0~13.0	100	49	GER20/1.0	M7	35	34
	SDC16P - 100	1.0~16.0	100	50	GER25/1.0	M7	42	41
	SDC20P - 110	1.0~20.0	110	60	GER32/1.0	M7	50	49
HSK100A -	SDC16P - 110	1.0~16.0	110	50	GER25/1.0	M13	42	41
	SDC20P - 120	2.0~20.0	120	60	GER32/1.0	M10	50	49

➔ Piezas de refacción 126

• Sistema de lubricación interno es opcional

• Seleccione el portapinzas correcto para herramientas con refrigeración interior

Partes

División	Piezas de Refacción			
	Básico		Opcional	
	Tuerca de agarre	Tornillo de Ajuste	Llave	Portapinzas
Tipo				
SDC7	RN11	BN0716F	20-22	GER/ER 11-ØD
SDC10	RN16	BN1025F	32-35	GER/ER 16-ØD
SDC13	RN20	BN1325F	35-38	GER/ER 20-ØD
SDC16	RN25	BN1830F	42-46	GER/ER 25-ØD
SDC20	RN32	BN2230F	48-52	GER/ER 32-ØD
SDC26	RN40	BN2838F	62-65	GER/ER 40-ØD

• Notas: para RU20, encargue llaves de 35-38; para R20, llaves S-30



S-SDC

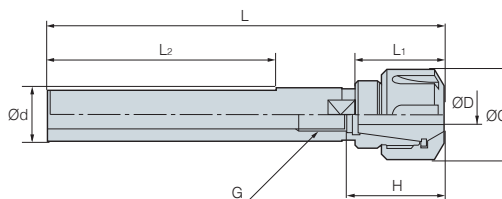

Código		ØD	Ød	ØC	L	L ₁	L ₂	H	Portapinzas ER / rango	G	(mm)
S16 -	SDC7 - 120M	1.0~7.0	16	19	120	-	-	33	GER11/0.5	M7	0.2
	120T	1.0~7.0	16	19	120	-	73	33	GER11/0.5	M7	0.2
	SDC10 - 150T	1.0~10.0	16	28	150	46.5	83	34.5	GER16/1.0	M10	0.2
S20 -	SDC10 - 150M	1.0~10.0	20	28	150	26.5	-	34.5	GER16/1.0	M10	0.3
	150T	1.0~10.0	20	28	150	26.5	83	34.5	GER16/1.0	M10	0.3
	SDC13 - 150M	1.0~13.0	20	35	150	50	-	49	GER20/1.0	M13	0.3
	150T	1.0~13.0	20	35	150	50	83	49	GER20/1.0	M13	0.3
S25 -	SDC10 - 150M	1.0~10.0	25	28	150	-	-	34.5	GER16/1.0	M10	0.5
	150T	1.0~10.0	25	28	150	-	83	34.5	GER16/1.0	M10	0.5
	SDC13 - 150M	1.0~13.0	25	35	150	-	-	49	GER20/1.0	M13	0.5
	150T	1.0~13.0	25	35	150	-	83	49	GER20/1.0	M13	0.5
S32 -	SDC13 - 150M	1.0~13.0	32	35	150	-	-	49	GER20/1.0	M13	0.7
	150T	1.0~13.0	32	35	150	-	83	49	GER20/1.0	M13	0.7
	SDC20 - 165M	2.0~20.0	32	50	165	-	-	60	GER32/1.0	M22	0.7
	165T	2.0~20.0	32	50	165	-	83	60	GER32/1.0	M22	0.7

➔ Piezas de refacción 128

• Sistema de lubricación interno es opcional



S-SDC/S

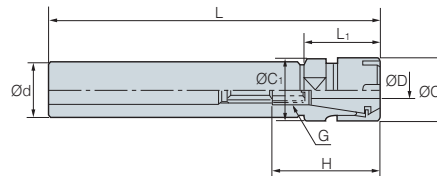

Fig. 1

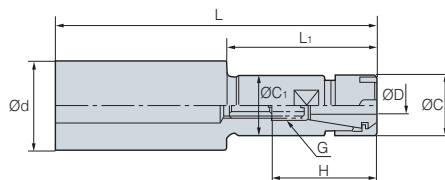



Fig. 2

(mm)

Código	ØD	Ød	ØC	L	L1	H	Portapinzas ER / rango	G		
S16 -	SDC7S - 100M	1.0~7.0	16	16	100	-	33	GER11/0.5	M7	0.2
		150M	1.0~7.0	16	16	150	-	33	GER11/0.5	M7
	SDC10S - 100M	1.0~10.0	16	22	100	50	44.5	GER16/1.0	M10	0.3
		150M	1.0~10.0	16	22	150	50	44.5	GER16/1.0	M10
S20 -	SDC7S - 100M	1.0~7.0	20	16	100	30	35	GER11/0.5	M7	0.3
		150M	1.0~7.0	20	16	150	80	35	GER11/0.5	M7
	SDC10S - 100M	1.0~10.0	20	22	100	50	44.5	GER16/1.0	M10	0.3
		150M	1.0~10.0	20	22	150	50	44.5	GER16/1.0	M10
	SDC13S - 100M	1.0~13.0	20	28	100	50	49	GER20/1.0	M13	0.3
		150M	1.0~13.0	20	28	150	50	49	GER20/1.0	M13
S25 -	SDC7S - 100M	1.0~7.0	25	16	100	30	33	GER11/0.5	M7	0.4
		150M	1.0~7.0	25	16	150	80	33	GER11/0.5	M7
	SDC10S - 100M	1.0~10.0	25	22	100	30	44.5	GER16/1.0	M10	0.4
		150M	1.0~10.0	25	22	150	80	44.5	GER16/1.0	M10
	SDC13S - 100M	1.0~13.0	25	28	100	-	49	GER20/1.0	M13	0.5
		150M	1.0~13.0	25	28	150	-	49	GER20/1.0	M13
	SDC16S - 100M	1.0~16.0	25	35	100	50	50	GER25/1.0	M18	0.5
		150M	1.0~16.0	25	35	150	50	50	GER25/1.0	M18
S32 -	SDC16S - 120M	1.0~16.0	32	35	120	-	50	GER25/1.0	M18	1
		150M	1.0~16.0	32	35	150	-	50	GER25/1.0	M18

• Sistema de lubricación interno es opcional

Partes

División	Piezas de Refacción			
	Básico		Opcional	
	Tuerca	Tornillo de Ajuste	Llave	(G)ER Portapinzas
Tipo				
SDC7S	R11M	BN0716F	M11M	(G)ER 11-ØD
SDC10S	R16M	BN1025F	M16M	(G)ER 16-ØD
SDC13S	R20M	BN1325F	M20M	(G)ER 20-ØD
SDC16S	R25M	BN1830F	M25M	(G)ER 25-ØD



BT-GSK

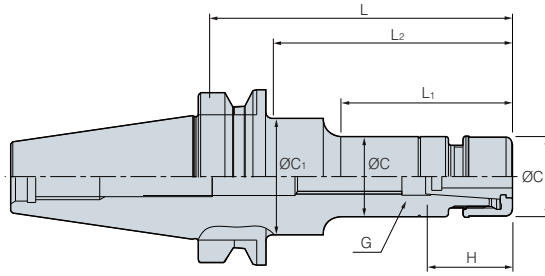

Código		ØD	L	L ₁	L ₂	H	Portapinzas ER / rango	G	ØC	ØC ₁	 kg	Rpm máximas
BT30 -	GSK6 - 60	1.0~6.0	60	33	33	35	HC6/0.5	M8	19.5	19.5	0.7	25,000
	90	1.0~6.0	90	56	65	35	HC6/0.5	M8	19.5	32	0.8	25,000
	GSK10 - 60	2.0~10.0	60	35	35	50	HC10/0.5	M12	27	27	0.9	25,000
	90	2.0~10.0	90	65	65	50	HC10/0.5	M12	27	27	1.0	25,000
	GSK13 - 60	3.0~13.0	60	36	36	43	HC13/1.0	M12	35	35	0.6	25,000
	GSK16 - 60	3.0~16.0	60	37	37	60	HC16/0.5	M12	40	40	1.1	25,000
	90	3.0~16.0	90	67	67	60	HC16/0.5	M18	40	40	1.2	25,000
GSK25 - 90	16.0~25.0	90	67.5	67.5	63.5	HC25/0.5	M12	55	55	1.1	25,000	
BT40 -	GSK6 - 90	1.0~6.0	90	51	61	35	HC6/0.5	M8	19.5	32	1.1	20,000
	120	1.0~6.0	120	60	90	35	HC6/0.5	M8	19.5	32	1.4	20,000
	150	1.0~6.0	150	60	120	35	HC6/0.5	M8	19.5	25	1.5	20,000
	GSK10 - 90	2.0~6.0	90	48	60	50	HC10/0.5	M12	27	40	1.2	20,000
	120	2.0~6.0	120	73	90	50	HC10/0.5	M12	27	40	1.4	20,000
	150	2.0~6.0	150	73	118	50	HC10/0.5	M12	27	34.5	1.6	20,000
	GSK13 - 90	3.0~13.0	90	59	59	43	HC13/1.0	M15	35	35	1.4	20,000
	GSK16 - 90	3.0~16.0	90	58	58	60	HC16/0.5	M18	40	40	1.5	20,000
	120	3.0~16.0	120	88	88	60	HC16/0.5	M18	40	40	1.7	20,000
	150	3.0~16.0	150	118	118	60	HC16/0.5	M18	40	40	1.9	20,000
	GSK20 - 90	4.0~20.0	90	60	60	70	HC20/0.5	M22	48	48	1.6	20,000
	120	4.0~20.0	120	90	90	70	HC20/0.5	M22	48	48	2.0	20,000
	GSK25- 90	16.0~25.0	90	61	61	75	HC25/0.5	M28	55	55	1.8	20,000
	120	16.0~25.0	120	91	91	85	HC25/0.5	M28	55	55	2.0	20,000
BT50 -	GSK6 - 105	1.0~6.0	105	55	64	35	HC6/0.5	M8	19.5	32	3.8	15,000
	135	1.0~6.0	135	60	92	35	HC6/0.5	M8	19.5	32	3.9	15,000
	165	1.0~6.0	165	60	114	35	HC6/0.5	M8	19.5	32	4.0	15,000
	GSK10 - 105	2.0~10.0	105	57	57	50	HC10/0.5	M12	27	27	3.8	15,000
	135	2.0~10.0	135	70	92	50	HC10/0.5	M12	27	32	4.0	15,000
	165	2.0~10.0	165	75	114	50	HC10/0.5	M12	27	36	4.2	15,000
	GSK13 - 135	3.0~13.0	135	92	92	43	HC13/1.0	M15	35	35	4.2	15,000
	GSK16 - 105	3.0~16.0	105	62	62	60	HC16/0.5	M18	40	40	4.1	15,000
	135	3.0~16.0	135	92	92	60	HC16/0.5	M18	40	40	4.3	15,000
	165	3.0~16.0	165	40	122	60	HC16/0.5	M18	40	50	4.5	15,000
	GSK20 - 105	4.0~20.0	105	62	62	70	HC20/0.5	M22	48	-	4.3	15,000
	135	4.0~20.0	135	92	92	70	HC20/0.5	M22	48	-	4.6	15,000
	165	4.0~20.0	165	122	122	70	HC20/0.5	M22	48	-	5.0	15,000
	GSK25 - 105	16.0~25.0	105	62	62	85	HC25/0.5	M28	55	55	4.8	15,000
	135	16.0~25.0	135	92	92	85	HC25/0.5	M28	55	55	5.2	15,000
165	16.0~25.0	165	122	122	85	HC25/0.5	M28	55	55	5.6	15,000	

 Piezas de refacción 130



HSK-GSK

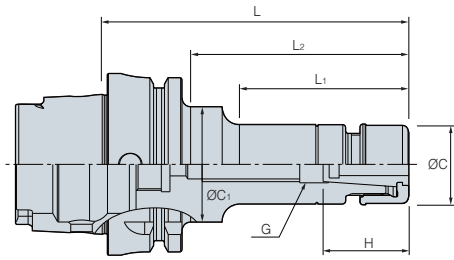

(mm)

Código	ØD	L ₁	L ₂	H	Portapinzas ER / rango	G	ØC	ØC ₁	Rpm máximas	
HSK63A -	GSK6 - 100	1.0~6.0	51	61	35	HC6/0.5	M8	19.5	32	20,000
	GSK10 - 105	2.0~6.0	73	118	50	HC10/0.5	M12	27	34.5	20,000
	GSK16 - 120	3.0~16.0	58	58	60	HC16/0.5	M18	40	40	20,000
	GSK20 - 120	4.0~20.0	60	60	70	HC20/0.5	M22	48	48	20,000
HSK100A -	GSK6 - 120	1.0~6.0	55	64	35	HC6/0.5	M8	19.5	32	15,000
	GSK10 - 120	2.0~10.0	57	57	50	HC10/0.5	M12	27	27	15,000
	GSK16 - 140	3.0~16.0	62	62	60	HC16/0.5	M18	40	40	15,000
	GSK25 - 155	16.0~25.0	62	62	85	HC25/0.5	M28	55	55	15,000

Partes

División	Piezas de Refacción		
	Básico		
	Tuerca	Tornillo de Ajuste	Extractor de pinza
Tipo			
GSK6	GN6	M820C	GSK-6CE
GSK10	GN10	M1230C	GSK-10CE
GSK13	GN13	BN1530F	GSK-13CE
GSK16	GN16	BN1830F	GSK-16CE
GSK20	GN20	BN2230F	GSK-20CE
GSK25	GN25	BN2838F	GSK-25CE

Llave (Opcional)



Código
GSK6
GSK10
GSK13
GSK16
GSK20
GSK25



Portapinzas ER de diámetro reducido

DSK

- Equilibrio G6.3 disponible para maquinado a max. 15,000 RPM
- Vibración minimizada de la herramienta durante el funcionamiento mediante el uso de boquilla 8°
- La tuerca de alta precisión de fabricación suiza mejora la estabilidad
- Diámetro del vástago aplicable: Ø1.8~Ø25



➤ Sistema de codificación



➤ Boquilla de primera clase (Hecha en Suiza )



Boquillas de fácil acoplaje



Herramientas endurecidas con tratamiento especial

➤ Aplicaciones multifuncionales

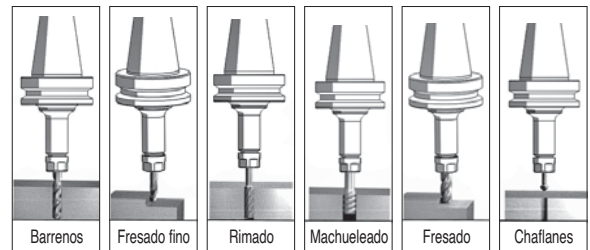

➤ Portapinzas

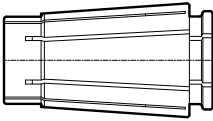
Tipo estandar & tipo precision	Designacion	Adaptador	Max a adaptar	Excentricidad
	HC6-Ød	10.5	6.0	Estándar Tipo 5µm
	HC10-Ød	15.5	10.0	
	HC13-Ød	20.1	13.0	Precision Tipo 3µm
	HC16-Ød	24.6	16.0	
	HC20-Ød	29.1	20.0	
	HC25-Ød	35.6	25.0	

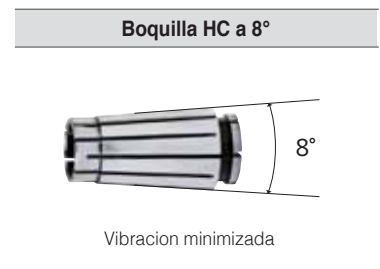

➤ Llave (opcional)

 <p>Llave</p>	Código	Chuck
	DSS-6	DSK-6
	DSS-10	DSK-10
	DSS-16	DSK-16
	DSS-20	DSK-20
	DSS-25	DSK-25

 <p>Extractor de pinza</p>	Código	Chuck
	DSS-6	DSK-6
	DSS-10	DSK-10
	DSS-16	DSK-16
	DSS-20	DSK-20
	DSS-25	DSK-25



BT-DSK

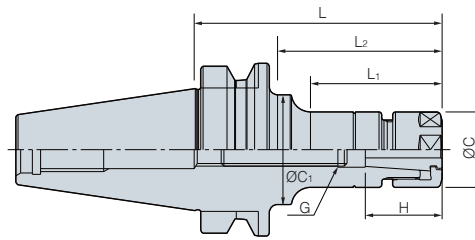

(mm)

Código		ØD	L	L ₁	L ₂	H	Portapinzas ER / rango	G	ØC	ØC ₁	 kg	Rpm máximas
BT30 -	DSK6 - 60	1.0~6.0	60	33	33	35	HC6/0.5	M8	19.5	19.5	0.7	15,000
	90	1.0~6.0	90	56	65	35	HC6/0.5	M8	19.5	32	0.8	15,000
	DSK10- 60	2.0~10.0	60	35	35	50	HC10/0.5	M12	27.5	27.5	0.9	15,000
	90	2.0~10.0	90	65	65	50	HC10/0.5	M12	27.5	27.5	1.0	15,000
	DSK13 - 60	3.0~13.0	60	36	36	43	HC13/0.5	M12	33	33	0.6	15,000
	DSK16 - 60	3.0~16.0	60	37	37	60	HC16/0.5	M12	40	40	1.1	15,000
	90	3.0~16.0	90	67	67	60	HC16/0.5	M18	40	40	1.2	15,000
DSK25 - 90	16.0~25.0	90	67.5	67.5	63.5	HC25/0.5	M12	55	55	1.1	15,000	
BT40 -	DSK6 - 90	1.0~6.0	90	51	61	35	HC6/0.5	M8	19.5	32	1.1	10,000
	120	1.0~6.0	120	60	90	35	HC6/0.5	M8	19.5	32	1.4	10,000
	150	1.0~6.0	150	60	120	35	HC6/0.5	M8	19.5	25	1.5	10,000
	DSK10 - 90	2.0~6.0	90	48	60	50	HC10/0.5	M12	27.5	40	1.2	10,000
	120	2.0~6.0	120	73	90	50	HC10/0.5	M12	27.5	40	1.4	10,000
	150	2.0~6.0	150	73	118	50	HC10/0.5	M12	27.5	34.5	1.6	10,000
	DSK13 - 90	3.0~13.0	90	59	59	43	HC13/1.0	M15	33	33	1.4	10,000
	DSK16 - 90	3.0~16.0	90	58	58	60	HC16/0.5	M18	40	40	1.5	10,000
	120	3.0~16.0	120	88	88	60	HC16/0.5	M18	40	40	1.7	10,000
	150	3.0~16.0	150	118	118	60	HC16/0.5	M18	40	40	1.9	10,000
	DSK20 - 90	4.0~20.0	90	60	60	70	HC20/0.5	M22	46.5	48.5	1.6	10,000
	120	4.0~20.0	120	90	90	70	HC20/0.5	M22	46.5	48.5	2.0	10,000
	DSK25 - 90	16.0~25.0	90	61	61	75	HC25/0.5	M28	55	55	1.8	10,000
120	16.0~25.0	120	91	91	85	HC25/0.5	M28	55	55	2.0	10,000	

 Piezas de refacción 133

• Sistema de lubricación interno es opcional

• Se recomiendan las boquillas de refrigerante cuando se usa el sistema de refrigerante



BT-DSK

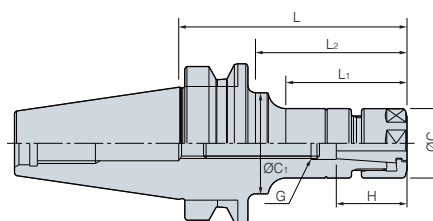

													(mm)
Código			ØD	L	L ₁	L ₂	H	Portapinzas ER / rango	G	ØC	ØC ₁	 kg	Rpm máximas
BT50 -	DSK6 -	105	1.0~6.0	105	55	64	35	HC6/0.5	M8	19.5	32	3.8	8,000
		135	1.0~6.0	135	60	92	35	HC6/0.5	M8	19.5	32	3.9	8,000
		165	1.0~6.0	165	60	114	35	HC6/0.5	M8	19.5	32	4.0	8,000
	DSK10 -	105	2.0~10.0	105	57	57	50	HC10/0.5	M12	27.5	27.5	3.8	8,000
		135	2.0~10.0	135	70	92	50	HC10/0.5	M12	27.5	32	4.0	8,000
		165	2.0~10.0	165	75	114	50	HC10/0.5	M12	27.5	36	4.2	8,000
	DSK13 -	135	3.0~13.0	135	92	92	43	HC13/1.0	M15	33	33	4.2	8,000
	DSK16 -	105	3.0~16.0	105	62	62	60	HC16/0.5	M18	40	40	4.1	8,000
		135	3.0~16.0	135	92	92	60	HC16/0.5	M18	40	40	4.3	8,000
		165	3.0~16.0	165	40	122	60	HC16/0.5	M18	40	50	4.5	8,000
	DSK20 -	105	4.0~20.0	105	62	62	70	HC20/0.5	M22	48.5	-	4.3	8,000
		135	4.0~20.0	135	92	92	70	HC20/0.5	M22	48.5	-	4.6	8,000
		165	4.0~20.0	165	122	122	70	HC20/0.5	M22	48.5	-	5.0	8,000
	DSK25 -	105	16.0~25.0	105	62	62	85	HC25/0.5	M28	55	55	4.8	8,000
		135	16.0~25.0	135	92	92	85	HC25/0.5	M28	55	55	5.2	8,000
165		16.0~25.0	165	122	122	85	HC25/0.5	M28	55	55	5.6	8,000	

• Sistema de lubricación interno es opcional

• Se recomiendan las boquillas de refrigerante cuando se usa el sistema de refrigerante

 Partes

División	Piezas de Refacción		
	Opcional		
	Tuerca	Tornillo de Ajuste	Llave
Tipo			
DSK6	DN6	BN0825F	DSS-6
DSK10	DN10	BN1225F	DSS10
DSK16	DN16	BN1830F	DSS16
DSK20	DN20	BN2230F	DSS20
DSK25	DN25	BN2838F	DSS25

Información técnica para portapinzas GERC

GER Boquilla_GER

GERC *new*

- Pinza resistente a la corrosión a micro unidad
- Recubrimiento de alta tecnología para una precisión duradera
- Mayor vida útil de la herramienta y mayor productividad.



➤ Sistema de codificación



➤ Tecnología especial para recubrimiento

A diferencia de las pinzas GERC, las pinzas no recubiertas convencionales tienen las siguientes características:
Las pinzas no recubiertas se ven afectadas por la corrosión debido a la alta humedad, el fluido de corte, el limpiador, la sal, el gas y muchos otros factores, lo que en consecuencia deteriora toda la calidad del mecanizado.

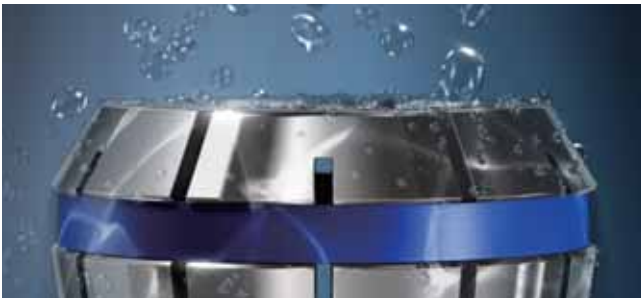

Cuando un collar se oxida, la vida útil de la herramienta se reduce y la precisión disminuye considerablemente. Para prevenir este problema, el tratamiento de la superficie por Se aplicó una micro unidad a las pinzas GERC para una protección eficaz y larga precisión duradera.



GERC



Competencia

Dos muestras de pinzas después de 4 meses de uso. Izquierda: pinza GERC, derecha: sin recubrimiento

➤ GERC-HP

Un mandril de precisión del tipo pinza es caro que Estándar, pero aún tiene más ventajas en largo. Término costo y eficiencia. Usando GERC-HP puede Minimizar el reprocesamiento caro debido a una menor tolerancia con máxima precisión



Boquilla tipo precisión 2 μ m

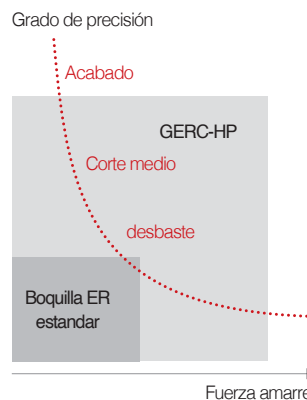

➤ Precisión (L/D = 3)

Boquilla tipo estandar 5 μ m
Boquilla tipo precisión 2 μ m

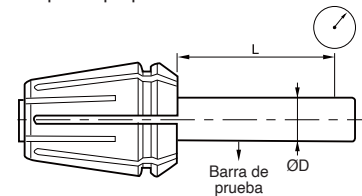

GERC Portapinzas

Tipo de precisión / Tipo de alta precisión

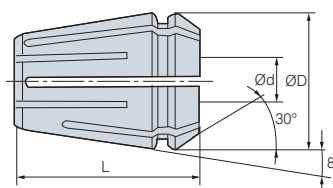

(mm)

Código	Tamaño pinza	ØD	L	Ød (Max.)	Rango (mm)	Tolerancia	
						General Tipo	Precisión Tipo (HP)
GER11 - Ød(HP)	11	11.5	18.0	7.0	0.5	5 µm	2 µm
GER16 - Ød(HP)	16	17.0	27.5	10.0	1.0		
GER20 - Ød(HP)	20	21.0	31.5	13.0	1.0		
GER25 - Ød(HP)	25	26.0	34.0	16.0	1.0		
GER32 - Ød(HP)	32	33.0	40.0	20.0	1.0		
GER40 - Ød(HP)	40	41.0	46.0	26.0	1.0		

ER Portapinzas

Tipo sistema de lubricación interno

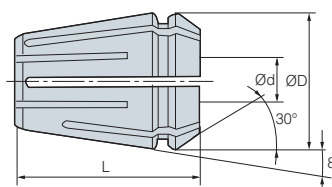

(mm)

Código	Tamaño pinza	ØD	L	Ød (Max.)	Diámetro mínimo de tipo lubricante	Rango (mm)	Tolerancia
							10 µm
ER11 - Ød	11	11.5	18.0	7.0	-	0.5	10 µm
ER16 - Ød(C)	16	17.0	27.5	10.0	4.0	1.0	
ER20 - Ød(C)	20	21.0	31.5	13.0	6.0	1.0	
ER25 - Ød(C)	25	26.0	34.0	16.0	6.0	1.0	
ER32 - Ød(C)	32	33.0	40.0	20.0	8.0	1.0	
ER40 - Ød(C)	40	41.0	46.0	26.0	10.0	1.0	

HC Portapinzas ER de diámetro reducido

Diámetro mínimo de tipo lubricante

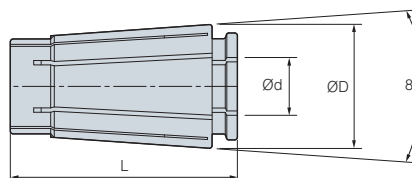

(mm)

Código	ØD	L	Ød (Max.)	Distance (mm)	Tolerancia	
					General Tipo	Precisión Tipo (HP)
HC6 - Ød(P)	10.5	25.0	6.0	1.0	5 µm	3 µm
HC10 - Ød(P)	15.6	30.5	10.0	1.0		
HC13 - Ød(P)	20.1	39.0	13.0	1.0		
HC16 - Ød(P)	24.6	45.0	16.0	1.0		
HC20 - Ød(P)	29.2	54.3	20.0	1.0		
HC25 - Ød(P)	35.7	57.0	25.0	1.0		



GERC Portapinzas

Tipo de precisión



(mm)

Código	Ød	Rango	Cantidad de portapinzas	Tolerancia
GERC11 1.0-7.0mm/0.5mm	1.0-7.0	0.5	13pcs	5 µm
GERC16 1.0-10.0mm/1.0mm	1.0-10.0	1.0	10pcs	5 µm
GERC20 2.0-13.0mm/1.0mm	2.0-13.0	1.0	12pcs	5 µm
GERC25 2.0-16.0mm/1.0mm	2.0-16.0	1.0	15pcs	5 µm
GERC32 3.0-20.0mm/1.0mm	3.0-20.0	1.0	18pcs	5 µm
GERC40 4.0-26.0mm/1.0mm	4.0-26.0	1.0	23pcs	5 µm

ER Portapinzas

General Tipo



(mm)

Código	Ød	Rango	Cantidad de portapinzas	Tolerancia
ER11(SET)	1.5-7.0	0.5	12pcs	10 µm
ER16(SET)	2.0-10.0	1.0	10pcs	10 µm
ER20(SET)	2.0-13.0	1.0	12pcs	10 µm
ER25(SET)	2.0-16.0	1.0	15pcs	10 µm
ER32(SET)	3.0-20.0	1.0	18pcs	10 µm
ER40(SET)	6.0-26.0	1.0	21pcs	15 µm



Adaptador machos de alta velocidad

DST *new*

- Mandril roscado para maquinado de alta velocidad
- Estructura especialmente diseñada para absorber la carga de empuje y evitando daños en el grifo
- A través del sistema de refrigeración disponible.
- Rango aplicable: M1-M22



➤ Sistema de codificación



➤ Excelentes resultados, maquinado preciso

área de maquinado excelente

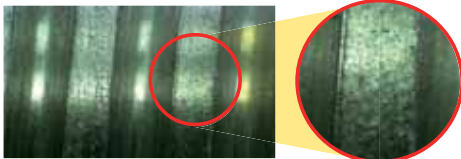

DST22
(vc = 100 m/min)

Excelente corte

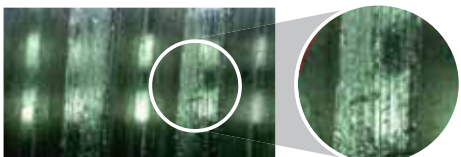

Adaptador convencional

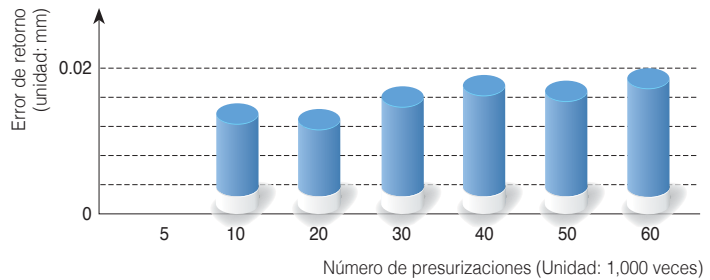

Adaptador exclusivo para rosca

- Al roscar usar adaptador TER
- DST3: usar adaptador ER11

➤ Comparación de los perfiles de la rosca

Parte de entrada después de un uso Extremo del macho después de un uso



DST



Adaptador portapinzas normal

Adaptador Synchro tap (DST7)



Buena figura de las estrías y en forma

Adaptador portapinzas general



El hilo está fuera de su forma. debido a un error de sincronización



BT-DST

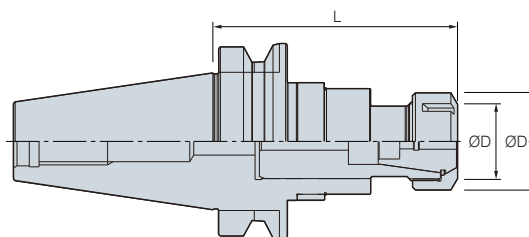

(mm)

Código	ØD	ØD ₁	L	Portapinzas	Rango del Machuelo	F-	F+	
BT30 -	DST3 - 70	26	19	70	ER11	M1~M3	0.5	0.5
	DST10 - 95	40.4	28	95	TER16	M3~M10	0.5	0.5
BT40 -	DST10 - 100	40.4	28	100	TER16	M3~M10	0.5	0.5
	DST22 - 110	60	49.5	110	TER32	M6~M22	0.7	0.7
BT50 -	DST10 - 110	60	49.5	110	TER16	M3~M10	0.5	0.5
	DST22 - 130	60	49.5	125	TER32	M6~M22	0.7	0.7

Portapinzas 135, 143

• Sistema de lubricación interno es opcional

HSK-DST

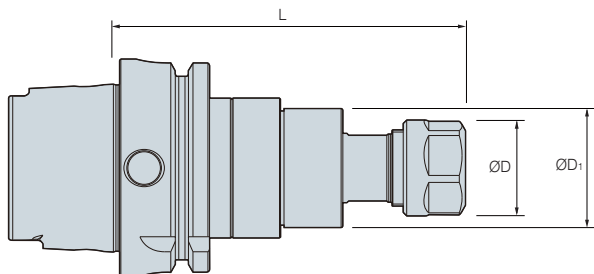

(mm)

Código	ØD	ØD ₁	L	Portapinzas	Rango del Machuelo	F-	F+	
HSK63A -	DST10 - 100	40.4	28	100	TER16	M3~M10	0.5	0.5
	DST22 - 130	60	49.5	130	TER32	M6~M22	0.7	0.7

Portapinzas 143

• Sistema de lubricación interno es opcional



BT-NPU

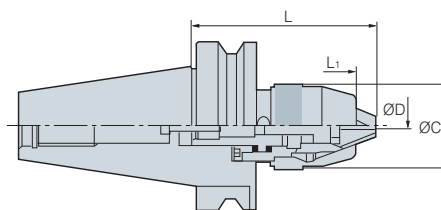

Código		ØD (Rango de amarre)	ØC	L	L ₁	
BT30 -	NPU8 - 97	0~8	38	97	8.5	0.8
	NPU13 - 125	1~13	50	125	12.5	1.5
BT40 -	NPU8 - 87	0~8	38	87	8.5	1.3
	NPU13 - 105	1~13	50	105	12.5	1.7
	NPU1a3 - 130	1~13	50	130	12.5	2.0
BT50 -	NPU13 - 115	1~13	50	115	12.5	4.4
	NPU13 - 130	1~13	50	130	12.5	4.6
	NPU13 - 190	1~13	50	190	12.5	5.4

(mm)

• Sistema de lubricación interno no disponible

Partes

División	Piezas de Refacción		
	Básico		Opcional
	Adaptador	Tornillo	Llave
Tipo			
NPU08	NPU08	BX0820	NPU0836
NPU13	NPU13	BX0825	NPU1348

Serie DTN

Adaptador de machos

DTN

- Diseño compacto y delgado
- Mejor aprovechamiento de la fuerza
- Rango M3 ~ M38



☞ Sistema de codificación



☞ Cambio fácil del TCA (adaptador para machos)

Tipo de intercambio de un solo toque conveniente para alta precisión y mayor vida útil de la herramienta. La contracción de longitud es posible por vía axial flotante.

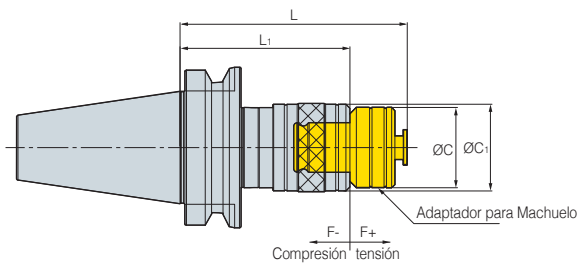

☞ Resultados mejorados



☞ Método de adaptación de machos de roscar en adaptador TCA

Antes de instalación	Después de instalación	Desmontaje
<ol style="list-style-type: none"> 1. Inserte la tuerca TCA empujando la cubierta del soporte del macho de roscar 2. Fije la tuerca TCA a la ranura principal con firmeza 	<ol style="list-style-type: none"> 1. Cubierta del soporte del macho de roscar colocada correctamente 	<ol style="list-style-type: none"> 1. Separe la tuerca TCA tirando de la cubierta del soporte del macho de roscar



BT-DTN

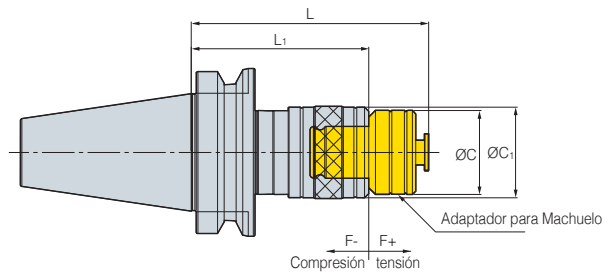

Código			Rango del Machuelo	L	L ₁	ØC	ØC ₁	Adaptador	F-	F+	(mm)
BT30 -	DTN12 -	85	M3~M12	85	60	32	39	TCA1-M	4	10	0.7
	DTN12 -	90	M3~M12	90	65	32	39	TCA1-M	4	10	1.2
BT40 -	120		M3~M12	120	95	32	39	TCA1-M	4	10	1.4
	DTN22 -	130	M8~M22	130	96	50	56	TCA2-M	12.5	12.5	1.7
	160		M8~M22	160	126	50	56	TCA2-M	12.5	12.5	2.1
BT50 -	DTN12 -	100	M3~M12	100	75	32	39	TCA1-M	4	10	3.7
	130		M3~M12	130	105	32	39	TCA1-M	4	10	3.9
	DTN22 -	140	M8~M22	140	104	50	56	TCA2-M	12.5	12.5	4.2
	170		M8~M22	170	134	50	56	TCA2-M	12.5	12.5	4.7
	DTN38 -	185	M16~M38	185	140	72	81	TCA3-M	20	20	5.7
	215		M16~M38	215	170	72	81	TCA3-M	20	20	6.6

➔ Adaptador Para machuelos (TCA) I42

• Sistema de lubricación interno no disponible • El adaptador para machos es opcional

S-DTN

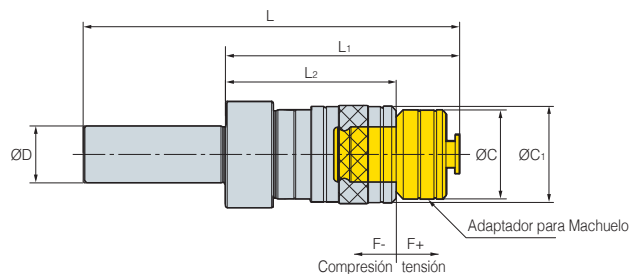

Código			Rango del Machuelo	ØD	L	L ₁	L ₂	ØD	ØD	F-	F+	Adaptador
S32 -	DTN12 -	90	M3-M12	32	170	90	65	32	39	4	10	TCA1
S32 -	DTN22 -	130	M8-M24	32	210	130	96	50	56	12.5	12.5	TCA2

➔ Adaptador Para machuelos (TCA) I42

• Sistema de lubricación interno no disponible • El adaptador para machos es opcional



TCA adaptador de machos

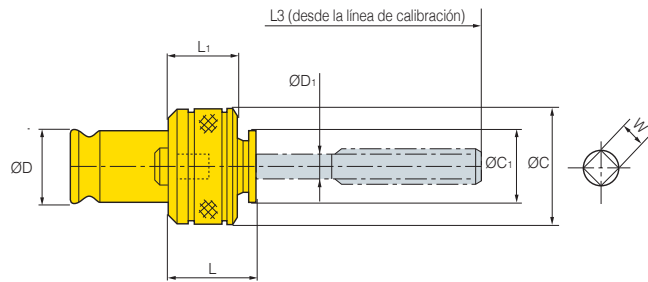

Código	ØD	ØC	L	L ₁		
TCA1 -	M3	3.2	24	22	0.2	
	M4	4	24	22	0.2	
	M5	5.5	4.5	24	22	0.2
	M6, 1/4U	6	4.5	24	22	0.2
	M8	6.2	5	25	22	0.2
	M10, 3/8U	7	5.5	25	22	0.2
	M11	8	6	39	22	0.2
	M12	8.5	6.5	26	22	0.2
TCA2 -	M8	5	38	28	0.6	
TCS2 -	M10	5.5	38	28	0.6	
TCA2 -	M12	6.5	39	28	0.6	
	M14, 3/4U	8	41	28	0.6	
	P1/4	9	31	28	0.6	
TCS2 -	M16	10	43	28	0.6	
TCA2 -	M18, P3/8	11	44	28	0.6	
	M20	12	45	28	0.6	
	M22	13	46	28	0.6	
	P1/2	14	36	28	0.6	
	M24	15	46	28	1.8	
TCA3 -	M16	10	35	37	1.8	
	M18	11	37	37	1.8	
	M20	12	37	37	1.8	
	M22	13	38	37	1.8	
	M24	15	44	37	1.8	
	M27, 1U	15	62	37	1.8	
	M30, P3/4	17	62	37	1.8	
	M33	19	66	37	1.8	
M36, M38	21	68	37	1.8		

• Productos estándar DIN pueden ser encargados • Sistema de lubricación interno no disponible



TER adaptador para machos

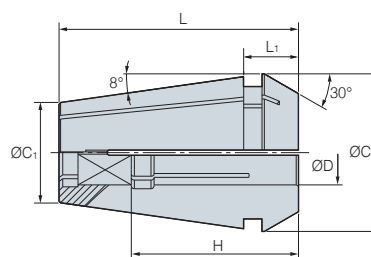
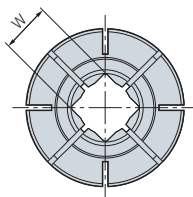

	Código	Estándar Tornillo	ØD	W	ØC	ØC ₁	L	L ₁	H
TER16 -	4x3.2	M3	4	3.2	16.74	10.1	27.5	6.3	18
	5x4	M4	5	4	16.74	10.1	27.5	6.3	18
	5.5x4.5	M5	5.5	4.5	16.74	10.1	27.5	6.3	18
	6x4.5	M6, U1/4	6	4.5	16.74	10.1	27.5	6.3	18
	6.2x5	M7, M8	6.2	5	16.74	10.1	27.5	6.3	18
	7x5.5	M9, M10, U3/8	7	5.5	16.74	10.1	27.5	6.3	18
TER20 -	5x4	M4	5	4	20.74	13.2	31.5	7.2	18
	5.5x4.5	M5	5.5	4.5	20.74	13.2	31.5	7.2	18
	6x4.5	M6, U1/4	6	4.5	20.74	13.2	31.5	7.2	18
	6.2x5	M7, M8	6.2	5	20.74	13.2	31.5	7.2	18
	7x5.5	M9, M10, U3/8	7	5.5	20.74	13.2	31.5	7.2	18
	8x6	M11, U7/16, P1/8	8	6	20.74	-	-	-	-
TER25 -	8.5x6.5	M12	8.5	6.5	20.74	13.2	31.5	7.2	22
	5x4	M4	5	4	25.74	17.6	34	7.5	18
	5.5x4.5	M5	5.5	4.5	25.74	17.6	34	7.5	18
	6x4.5	M6	6	4.5	25.74	17.6	34	7.5	18
	6.2x5	M7, M8	6.2	5	25.74	17.6	34	7.5	18
	7x5.5	M9, M10, U3/8	7	5.5	25.74	17.6	34	7.5	18
TER32 -	8.5x6.5	M12	8.5	6.5	25.74	17.6	34	7.5	22
	6x4.5	M6, U1/4	6	4.5	32.74	23.1	40	8.2	18
	6.2x5	M7, M8	6.2	5	32.74	23.1	40	8.2	18
	7x5.5	M9, M10, U3/8	7	5.5	32.74	23.1	40	8.2	18
	8X6	M11, U7/16, P1/8	8	6	32.74	23.1	40	8.2	22
	8.5x6.5	M12	8.5	6.5	32.74	23.1	40	8.2	22
	10.5x8	M14, U9/16	10.5	8	32.74	23.1	40	8.2	25
	12.5x10	M16	12.5	10	32.74	23.1	40	8.2	25
	14x11	M18, P3/8	14	11	32.74	23.1	40	8.2	25
	15x12	M20	15	12	32.74	23.1	40	8.2	25
	17x13	M22, U7/8	17	13	32.74	23.1	40	8.2	25
	11x9	P1/4	11	9	32.74	23.1	40	8.2	25
	12x9	U5/8	12	9	32.74	23.1	40	8.2	25
9x7	U1/2	9	7	32.74	23.1	40	8.2	22	

• Roscado con machos resistentes al agua disponibles con el uso de nuestras RTJW y nuestras tuercas (limitado a ciertas medidas)



BT-SLA

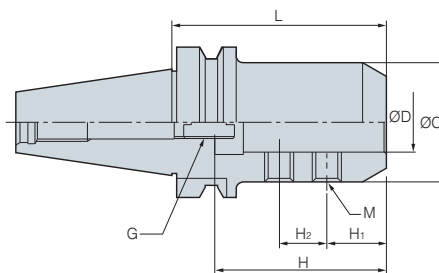

(mm)

Código	ØD	L	ØC	H	H ₁	H ₂	M	G		
BT30 -	SLA16 - 90	16	90	40	70	25	20	M10	M12	1.1
	SLA20 - 90	20	90	50	70	25	20	M12	M12	1.2
	SLA25 - 90	25	90	50	70	25	20	M12	M12	1.2
BT40 -	SLA16 - 90	16	90	40	70	25	20	M10	M12	1.5
	SLA20 - 90	20	90	50	70	25	20	M12	M12	1.8
	SLA25 - 90	25	90	50	70	25	20	M12	M12	2.0
	SLA32 - 90	32	90	60	80	25	25	M14	M12	2.2
	105	32	105	60	80	25	25	M14	M12	2.4
	SLA40 - 105	40	105	80	80	25	25	M16	M12	2.4
BT50 -	SLA16 - 90	16	90	40	70	25	20	M10	M12	4.2
	SLA20 - 105	20	105	50	70	25	20	M12	M12	4.4
	SLA25 - 105	25	105	50	70	25	20	M12	M12	4.4
	135	25	135	50	70	25	20	M12	M12	4.7
	SLA32 - 105	32	105	60	80	25	25	M14	M12	4.8
	135	32	135	60	80	25	25	M14	M12	5.4
	165	32	165	60	80	25	25	M14	M12	6.2
	SLA40 - 105	40	105	90	80	25	25	M16	M12	5.2
	150	40	150	90	80	25	25	M16	M12	5.8
SLA42 - 105	42	105	90	80	25	25	M16	M12	5.8	

 Piezas de Refacción 145

• Sistema de lubricación interno es opcional



HSK-SLA

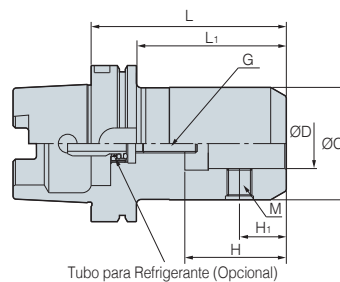

Código		ØD	L	ØC	H	H ₁	M	G	(mm)
HSK63A -	SLA20 - 100	20	100	52	51	25	M16	M12	2.0
	SLA25 - 105	25	105	65	59	25	M18	M12	2.7
	SLA32 - 105	32	105	72	63	30	M20	M12	2.9
HSK100A -	SLA20 - 105	20	105	52	51	25	M16	M12	3.9
	SLA25 - 110	25	110	65	59	25	M18	M12	4.0
	SLA32 - 125	32	125	72	63	30	M20	M12	4.3

• Sistema de lubricación interno es opcional

Partes

División	Piezas de Refacción				
	Básico		Opcional		
	Set Tornillo		Tornillo de Ajuste	Llave	
Tipo					
	DBT/BT Tipo	HSK/SK Tipo	M1230C	DBT/BT Tipo	HSK/SK Tipo
SLA16	BTF1010	BTF1414-1.5		LW-5	LW-6
SLA19	BTF1212-1.5	BTF1616-1.5		LW-6	LW-8
SLA20		BTF1818-1.5		LW-6	LW-10
SLA25	BTF1414-1.5	BTF2020-1.5		LW-6	
SLA32	BTF1624-1.5			LW-8	
SLA40					
SLA42					

BT-FMA

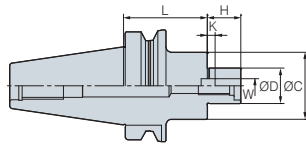

Fig. 1

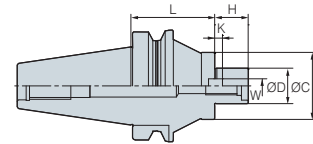

Fig. 2

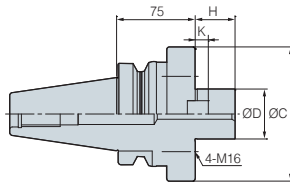
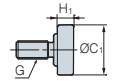

Fig. 3

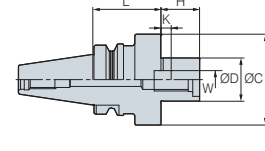
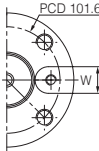



Fig. 4

(mm)

Código	Diámetro del Cortador	ØD	L	ØC	H	W	K	G		Fig.	
BT30 - FMA25.4 - 45	80	25.4	45	50	22	9.5	5	M12	1.2	4	
BT40 -	FMA25.4 - 45	80	25.4	45	50	22	9.5	5	M12	1.4	1
	FMA25.4 - 90	80	25.4	90	50	22	9.5	5	M12	3.1	1
	FMA31.75 - 45	100	31.75	45	60	30	12.7	7	M16	1.6	1
	FMA31.75 - 90	100	31.75	90	60	30	12.7	7	M16	3.0	1
	FMA38.1 - 60	125	38.1	60	80	34	15.87	9	M20	2.9	4
BT50 -	FMA25.4 - 45	80	25.4	45	50	22	9.5	5	M12	3.8	1
	FMA25.4 - 90	80	25.4	90	50	22	9.5	5	M12	4.5	1
	FMA25.4 - 150	80	25.4	150	50	22	9.5	5	M12	5.5	2
	FMA31.75 - 45	100	31.75	45	60	30	12.7	7	M16	4.6	1
	FMA31.75 - 75	100	31.75	75	60	30	12.7	7	M16	5.2	1
	FMA31.75 - 105	100	31.75	105	60	30	12.7	7	M16	6.0	2
	FMA38.1 - 45	125	38.1	45	80	34	15.87	9	M20	4.3	1
	FMA38.1 - 75	125	38.1	75	80	34	15.87	9	M20	5.5	1
	FMA50.8 - 45	160	50.8	45	100	36	19.05	10	M24	4.8	1
	FMA50.8 - 75	160	50.8	75	100	36	19.05	10	M24	6.8	1
FMA47.625 - 75	200	47.625	75	128	38	25.4	12.5	-	7.5	3	

• Sistema de lubricación interno es opcional • El peso arriba mencionado excluye el peso de la fresa

Partes

División	Piezas de Refacción				
	Básico				Opcional
	Cuña	Tornillo Sujeción	Perno de Sujeción	Perno de Sujeción	Llave
Tipo					
FMA22	K8.0	MBA-M10	BX0310	-	LW-8
FMA22.225	K8.0	MBA-M10	BX0310	-	LW-8
FMA25.4	K9.5	MBA-M12	BX0412	BX1230	LW-10
FMA31.75	K12.7	MBA-M16	BX0516	-	LW-14
FMA38.1	K15.87	MBA-M20	BX0616	-	LW-17
FMA50.8	K19.05	MBA-M24	BX0820	-	LW-19
FMA47.625	K25.4	-	BX1020	BX1645	-
S-FMA25.4	-	-	-	-	LW-10
S-FMA31.75	-	-	-	-	LW-14



BT-FMC

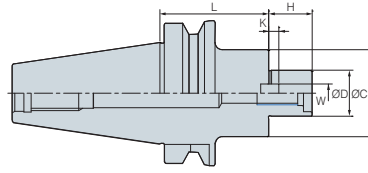

Fig. 1

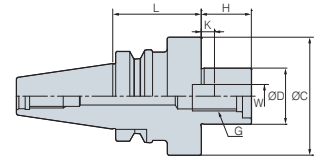

Fig. 2

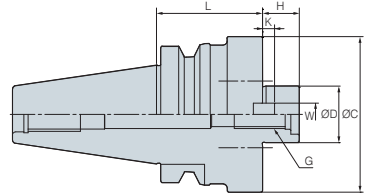
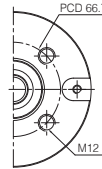

Fig. 3



												(mm)
	Código		Díámetro del Cortador	ØD	L	ØC	H	W	K	G		Fig.
BT30 -	FMC16 -	45	40	16	45	38	17	8	5.0	M8	0.7	1
	FMC22 -	45	50/63	22	45	48	19	10	5.6	M10	0.8	2
	FMC27 -	50	80	27	50	60	21	12	6.3	M12	1.2	2
BT40 -	FMC16 -	60	40	16	60	38	17	8	5.0	M8	1.2	1
	FMC22 -	45	50/63	22	45	48	19	10	5.6	M10	1.2	1
	FMC22 -	90	50/63	22	90	48	19	10	5.6	M10	1.2	1
	FMC27 -	60	80	27	60	60	21	12	6.3	M12	1.8	2
	FMC27 -	90	80	27	90	60	21	12	6.3	M12	3.2	2
	FMC32 -	60	100	32	60	78	24	14	7.0	M16	2.3	2
	FMC40 -	50	125/160	40	50	89	27	15.87	8.0	M20	3.3	3
BT50 -	FMC16 -	60	40	16	60	38	17	8	5.0	M8	3.9	1
	FMC22 -	60	50/63	22	60	48	19	10	5.6	M10	4.1	1
	FMC27 -	40	80	27	40	60	21	12	6.3	M12	4.1	1
	FMC27 -	90	80	27	90	60	21	12	6.3	M12	5.5	1
	FMC27 -	150	80	27	150	60	21	12	6.3	M12	6.1	1
	FMC32 -	45	100	32	45	78	24	14	7.0	M16	4.2	1
	FMC32 -	75	100	32	75	78	24	14	7.0	M16	4.2	1
	FMC32 -	105	100	32	105	78	24	14	7.0	M16	4.2	1
	FMC40 -	50	125/160	40	50	89	27	15.87	8.0	M20	4.6	3

• Sistema de lubricación interno es opcional • El peso arriba mencionado excluye el peso de la fresa

Partes

División	Piezas de Refacción				
	Básico				Opcional
	Cuña	Tornillo Sujeción	Perno de Sujeción	Perno de Sujeción	Llave
Tipo					
FMC 16	K8.0	-	BX0310	BX0830	LW-6
FMC 22	K10.0	-	BX0412	BX1030	LW-8
FMC 25.4	K9.5	-	BX0516	BX1230	LW-10
FMC 27	K12.0	MBA-M12	BX0616	-	LW-10
FMC 32	K14.0	MBA-M16	BX0616	-	LW-14
FMC38.1	K15.87	MBA-M16	BX0616	-	LW-14
FMC40	K15.87	MBA-M20	BX0616	-	LW-17



HSK-FMC

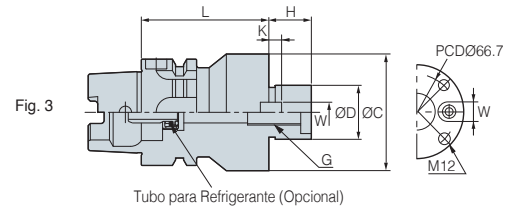
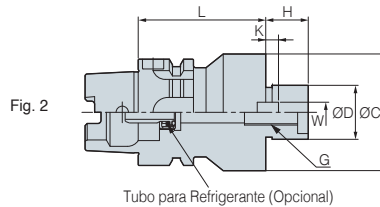
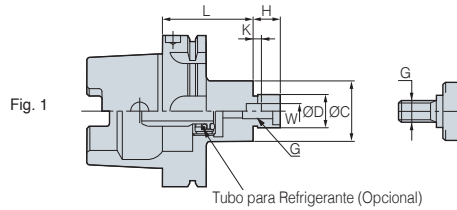





(mm)

Código	Díámetro del Cortador	ØD	L	ØC	H	W	K	G		Fig.	
HSK50A -	FMC16 - 40	40	16	40	38	17	8	5	M8	0.8	1
	FMC22 - 50	50/63	22	50	48	19	10	5.6	M10	0.9	1
HSK63A -	FMC16 - 50	40	16	50	38	17	8	5.0	M8	1.1	1
	FMC22 - 50	50/63	22	50	48	19	10	5.6	M10	1.2	1
	FMC27 - 60	80	27	60	60	21	12	6.3	M12	1.4	1
	FMC32 - 60	100	32	60	78	24	14	7.0	M16	1.8	2
	FMC40 - 60	125/160	40	60	89	27	15.87	8.0	M20	2	3

• Sistema de lubricación interno es opcional • El peso arriba mencionado excluye el peso de la fresa

Partes

División	Piezas de Refacción				
	Básico				Opcional
	Cuña	Tornillo Sujeción	Perno de Sujeción	Perno de Sujeción	Llave
Tipo					
FMC 16	K8.0	-	BX0310	BX0830	LW-6
FMC 22	K10.0	-	BX0412	BX1030	LW-8
FMC 25.4	K9.5	-	BX0516	BX1230	LW-10
FMC 27	K12.0	MBA-M12	BX0616	-	LW-10
FMC 32	K14.0	MBA-M16	BX0616	-	LW-14
FMC38.1	K15.87	MBA-M16	BX0616	-	LW-14
FMC40	K15.87	MBA-M20	BX0616	-	LW-17



Aumento de productividad de hasta el doble

Serie Cabeza Angular



Características

- Multi función/disponible para varios ángulos
- Cuerpo de aluminio, ligero

Sistema de codificación



Nombre de las partes de la cabeza angular



Aplicaciones variadas

0~90-ángulos rotación (MAH, KHU)	Fijado a 90-tipo grado (KAH)	Fijado a 45-tipo grado (KAC)	Tipo de amarre (HRAG, KAG)

Components

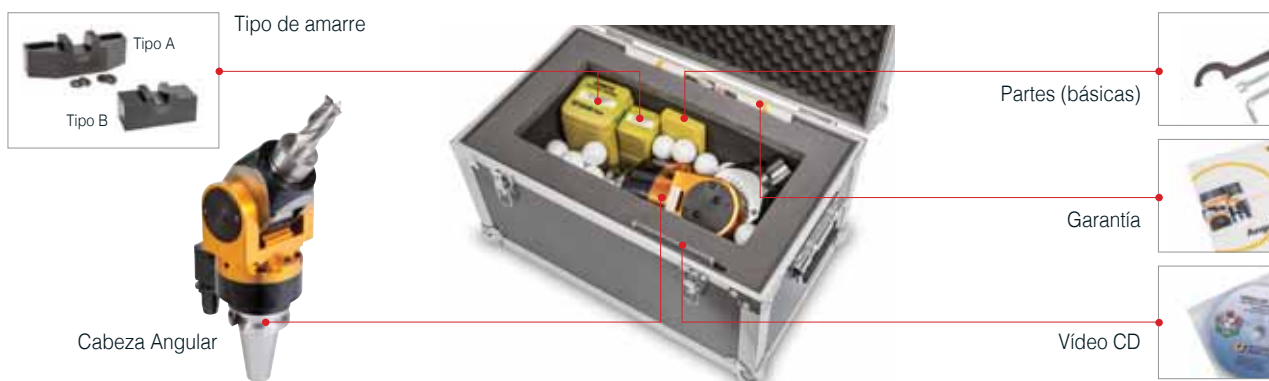

Serie Cabeza Angular

MAH

Tipo universal MAH (reforzado)

- Tipo reforzado Mejor rendimiento al mejorar la cabeza angular universal existente
 - Estabilidad en el mecanizado de moldes grandes
 - Utilice fresas integrales de 32 mm
 - Reforzado desde KHU Tipo



HRAG

Tipo adjunto HRAG (reforzado)

- Tipo reforzado, incrementando la vida útil hasta un 200%
 - Estabilidad en careado
 - Estabilidad mejorada



KHU

Tipo universal KHU

- Ajuste de ángulo libre hasta 90°
 - Los tipos HSK y SK son ordenados

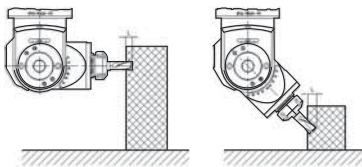

BT50-KHU20-195

KAG

Tipo adjunto KAG

- Ajuste de ángulo libre de 360° de lado a lado
 - Posible utilizar varias herramientas de BT40. y BT30
 - Los tipos HSK y SK son ordenados

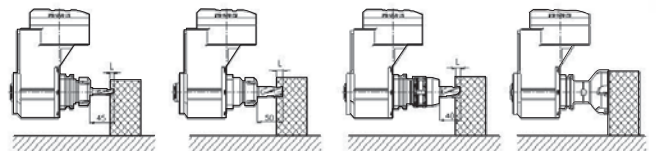

BT40-SDC20-60
(Ø12 E/M)

NT40-SDC20-60
(Ø20 E/M)

BT40-NPM20-85
(Ø20 E/M)

BT40-FMA25.4-45
(Ø80 Fresa para escuadrado)

KAH

Tipo modular KAH (90° Tipo)

- Cabezal angular fijo de 90°
 - En caso de usar una pinza, por favor contáctenos con anticipación
 - Los tipos HSK y SK son ordenados

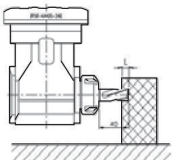

BT50-KAH20-200

KAC

Tipo modular KAC (45° Tipo)

- Cabezal angular fijo de 45°
 - Los tipos HSK y SK son ordenados



MHA para moldes (0°~90°)_Tipo Reforzado

BT-MAH

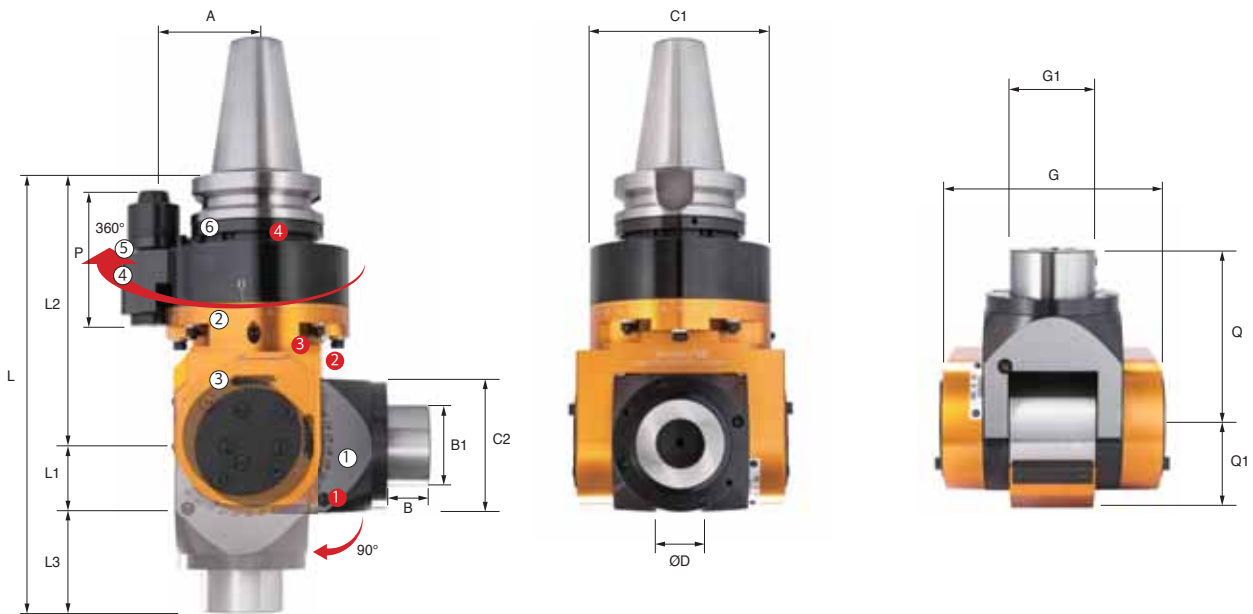

Pin de posición

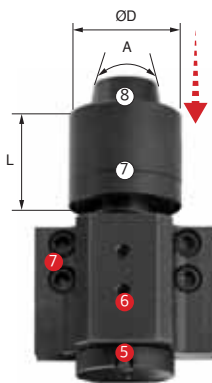

Tamaño husillo	L	A	ØD
BT50	56.5	30°	Ø40

NO	Nombre
①	Graduación ángulo inclinación (Posición axial 0°~90°)
②	Graduación ángulo de rotación (Posición radial libre 360°)
③	Cabeza
④	Parte posicionamiento pin
⑤	Llave husillo
⑥	Anillo de posición
⑦	Recubrimiento anillo posición
⑧	Pin de posición

NO	Nombre parte	Código
①	Tornillo ángulo inclinación	BT1216
②	Tornillos posicionamiento cabeza	BT0645
③	Tornillo graduación ángulo de rotación	BT0640
④	Tornillo posición anillo	MSST5-12
⑤	Control altura pin de posición	BT0516
⑥	Tornillos pin de posición	BT0512
⑦	Tornillos posición bloque	BX0516

Código	ØD	L	L1	L2	L3	C	C1	G	C2	Q	Q1	B	B1	P	A	Rpm máximas	Herramienta de instalación	kg
BT50-MAH32-200	32	200	47	78	325	136	95	154	95	125	63	31	60	95	80	3,000	Trabe lateral	19



Serie Cabeza Angular

HRAG (fijado a 90°)_Tipo Reforzado

BT-HRAG

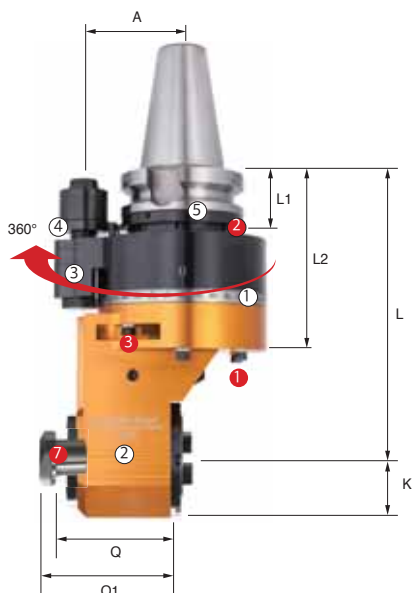

Pin de posición

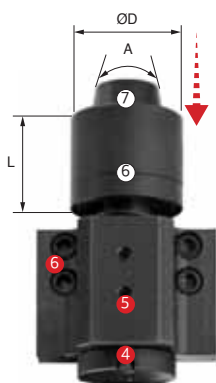

Tamaño husillo	L	A	ØD
BT50	56.5	30°	Ø40

NO	Nombre
①	Graduación ángulo de rotación (Posición radial libre 360°)
②	Cabeza
③	Parte posicionamiento pin
④	Llave husillo
⑤	Anillo de posición
⑥	Recubrimiento anillo posición
⑦	Pin de posición

NO	Nombre parte	Código
①	Tornillos posicionamiento cabeza	BX0660
②	Tornillo posición anillo	MSST5-12
③	Tornillo ángulo inclinación	BT0648
④	Control altura pin de posición	BT0516
⑤	Tornillos pin de posición	BT0512
⑥	Tornillos posición bloque	BX0516
⑦	BT/NT Tornillo	

Código	L	L1	L2	L3	L4	Q	Q1	A	G	G1	Rpm máximas	Husillo	kg
BT50-HRAG40-230	230	56.5	145	46.5	276.5	89	101	80	93	136	3000	BT/NT40	15.75



KHU (0°~90°)_Tipo Portapinzas

BT-KHU



Pin de posición



Tamaño husillo	L	L1	A	ØD
BT40	Max: 32 Min: 26	10	20°	Ø19.6
BT50	Max: 35 Min: 29	15		Ø28

NO	Nombre
①	Graduación ángulo inclinación (Posición axial 0°~90°)
②	Graduación ángulo de rotación (Posición radial libre 360°)
③	Cabeza
④	Parte posicionamiento pin
⑤	Llave husillo
⑥	Llave control altura

NO	Nombre parte	Código
①	Tornillo ángulo de fijación de giro	BX0630
②	Tornillo ángulo de fijación pin de posición	BX0512
③	Set Tornillo	BT0404
④	Tornillos de acloppamiento	BXS0630

Código	ØD	ØD1	L	L1	L2	L3	B	B1	E	F	C	A	G	Q	Q1	Ratio del torque (entrada: salida)	Dirección de rotación (entrada: salida)	Rpm máximas	Portapinzas	kg
BT40-KHU10-160	1.0~10.0	58	160	33	54	247	22	28	51	98	96	65	90	87	40	1: 2	CW: CW	6,000	GER16	6.4
BT50-KHU10-180	1.0~10.0	58	180	33	54	267	22	28	53	103	114	80	90	87	40	1: 2	CW: CW	6,000	GER16	10.5
BT50-KHU20-195	2.0~20.0	84	195	47	73	315	29	50	53	132	114	80	124	120	63	1: 1	CW: CW	3,000	GER32	15.8



Serie Cabeza Angular

KAG (fijado a 90°)

BT-KAG

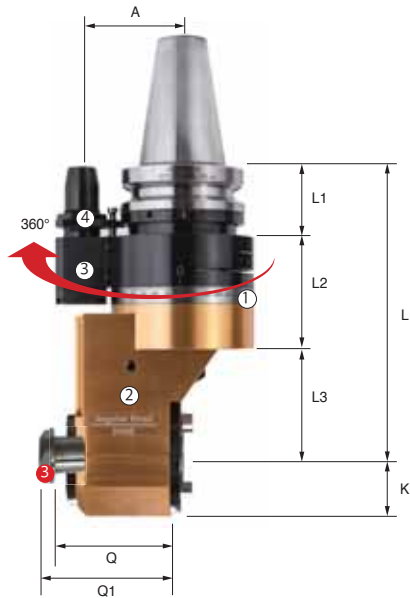

Pin de posición



Tamaño husillo	L	L1	A	ØD
BT40	Max: 32 Min: 26	10	20°	Ø19.6
BT50	Max: 35 Min: 29	15		Ø28

NO	Nombre
①	Graduación ángulo de rotación (Posición radial libre 360°)
②	Cabeza
③	Parte posicionamiento pin
④	Llave husillo
⑤	Llave control altura

NO	Nombre parte	Código
①	Set Tornillo	BT0404
②	Tornillos de acloplamiento	BXS0630
③	BT / NT Tornillo	

Código	L1	L2	L3	L4	L5	L6	Q	Q1	A	C	G	Ratio del torque (entrada: salida)	Dirección de rotación (entrada: salida)	Rpm máximas	Husillo	kg
BT40-KAG30-195	44	86	65	37.5	195	232.5	66	70	65	96	75	1: 1	CW: CW	4,000	BT30/NT30	6.4
BT50-KAG40-230	57	88	85	46.5	230	276.5	89	94	80	114	93	1: 1	CW: CW	3,000	BT40/NT40	15.8



HRAG (fijado a 90°)_Tipo Portapinzas

BT-KAH



Pin de posición

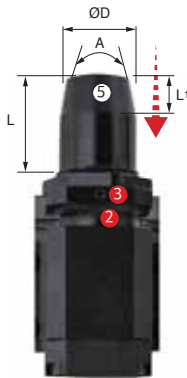

Tamaño husillo	L	L1	A	ØD
BT40	Max: 32 Min: 26	10	20°	Ø19.6
BT50	Max: 35 Min: 29	15		Ø28

NO	Nombre
①	Cabeza
②	Graduación ángulo de rotación (Posición radial libre 360°)
③	Parte posicionamiento pin
④	Llave husillo
⑤	Llave control altura

NO	Nombre parte	Código
①	Tornillos posicionamiento cabeza	BX0618
②	Set Tornillo	BT0404
③	Tornillos de acoplamiento	BXS0630

Código	ØD	L	L1	L2	L3	L4	B	A	P	Q	G	G1	Ratio del torque (entrada: salida)	Rpm máximas	Portapinzas	kg
BT40-KAH7-170	1.0~7.0	170	20	44	71	55	19	65	37	24.5	40	96	1: 1	5,000	GER11	4.6
BT40-KAH10-195	1.0~10.0	195	25	44	71	80	28	65	46	32	58	96	1: 1	5,000	GER16	5.8
BT40-KAH13-165	1.0~13.0	165	28	44	71	50	35	65	53	35	60	96	1: 1	5,000	GER20	5.7
BT40-KAH20-180	2.0~20.0	180	38	44	71	65	50	65	71	49	76	96	1: 1	3,500	GER32	6.7
BT50-KAH07-220	1.0~7.0	220	20	57	54	109	19	80	37	24.5	40	96	1: 1	5,000	GER11	9.8
BT50-KAH10-215	1.0~10.0	215	25	57	54	104	28	80	46	32	58	96	1: 1	5,000	GER16	10.7
BT50-KAH10-260	1.0~10.0	260	25	57	54	149	28	80	46	32	58	96	1: 1	5,000	GER16	11.0
BT50-KAH13-260	1.0~13.0	260	28	57	54	149	35	80	53	35	60	96	1: 1	5,000	GER20	11.2
BT50-KAH20-200	2.0~20.0	200	38	57	54	89	50	80	71	49	76	96	1: 1	3,500	GER32	11.6
BT50-KAH20-240	2.0~20.0	240	38	57	54	129	50	80	71	49	76	96	1: 1	3,500	GER32	12.4



Serie Cabeza Angular

KAC (fijado a 45°)_Tipo Portapinzas

BT-KAC

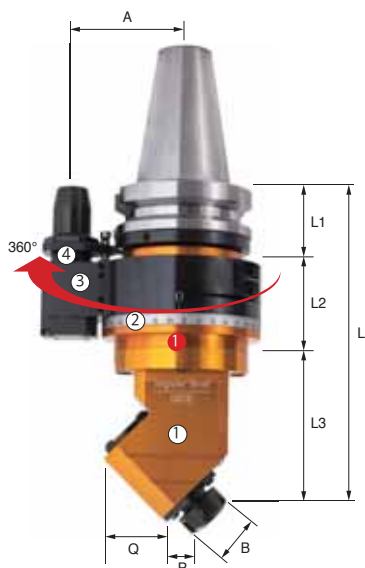

Pin de posición

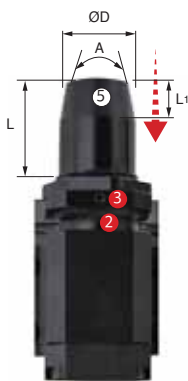

NO	Nombre
①	Cabeza
②	Graduación ángulo de rotación (Posición radial libre 360°)
③	Parte posicionamiento pin
④	Llave husillo
⑤	Llave control altura

NO	Nombre parte	Código
①	Tornillos posicionamiento cabeza	BX0618
②	Set Tornillo	BT0404
③	Tornillos de acoplamiento	BXS0630

Tamaño husillo	L	L1	A	ØD
BT40	Max: 32 Min: 26	10	20°	Ø19.6
BT50	Max: 35 Min: 29	15		

Código	ØD	L	L1	L2	L3	B	G	G1	P	Q	A	Rpm máximas	Portapinzas	kg
BT40-KAC10-220	1.0~10.0	220	44	71	105	28	60	96	25	54	65	5,000	GER16	5.3
BT40-KAC13-220	1.0~13.0	220	44	71	105	28	60	96	25	54	65	5,000	GER20	5.5
BT40-KAC20-230	2.0~20.0	230	44	71	115	50	72	96	30	60	65	3,500	GER32	6.8
BT50-KAC10-240	1.0~10.0	240	57	54	129	28	60	96	25	54	80	5,000	GER16	10.2
BT50-KAC13-240	1.0~13.0	240	57	54	129	28	60	96	25	54	80	5,000	GER20	10.4
BT50-KAC20-250	2.0~20.0	250	57	54	139	50	72	96	30	60	80	3,500	GER32	11.7



Barra Mandrinado

FBH/B

- Perforación a alta velocidad y aburrída hacia atrás
- Equilibrio de alta precisión G2.5, cabeza G6.3
- Min. rango de ajuste: 2µm



➤ Sistema de codificación



➤ Velocidad trabajo

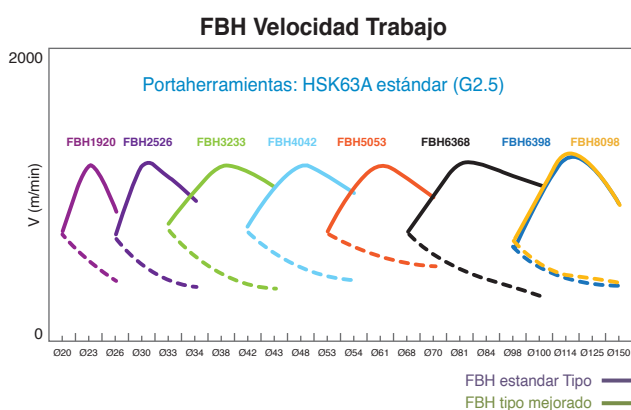

➤ Ajuste rango mandrinado



➤ Mandrinado hacia atrás

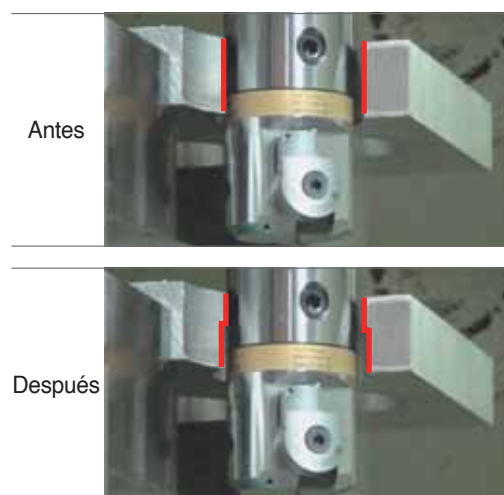

➤ Ajuste dirección de maquinado



Fácil cambio de dirección de maquinado. solo ajustando la mordida



BT-FBH/B



Herramienta de micro mandrinado, tipo "balance"

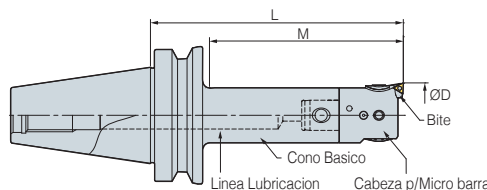

Código		Rango Boreador ØD		L	Profundidad Max. del Boreador M	kg		
Cabeza para/Boreado	Cartucho	Cuerpo (Básico holder)	Min				Max	
FBH1920B	FBB20N-□-□□	BT30 -	MD19F - 70R	20 (24)	26 (30)	103	60	0.5
FBH2526B	FBB26N-□-□□		MD25F - 90R	26 (32)	34 (40)	127	80	0.7
FBH3233B	FBB33N-□-□□		MD32F - 80R	33 (40)	43 (50)	121	80	0.8
FBH4042B	FBB42N-□-□□		MD40F - 80R	42 (50)	54 (62)	127	96	1.1
FBH5053B	FBB53N-□-□□		MD50F - 70	53 (65)	70 (82)	127	97	1.7
FBH1920B	FBB20N-□-□□	BT40 -	MD19F - 70R	20 (24)	26 (30)	103	45	1.9
FBH2526B	FBB26N-□-□□		MD25F - 95R	26 (32)	34 (40)	133	59	2
FBH3233B	FBB33N-□-□□		MD32F - 100R	33 (40)	43 (50)	141	77	2.5
FBH4042B	FBB42N-□-□□		MD40F - 115R	42 (50)	54 (62)	162	107	3.1
FBH5053B	FBB53N-□-□□		MD50F - 105	53 (65)	70 (82)	162	135	3.5
FBH6368B	FBB68N-□-□□	BT40 -	MD63F - 110	68 (90)	100 (122)	181	154	6.3
FBH6398B	FBB68N-□-□□		MD63F - 135	98 (120)	150 (172)	206	179	7.1
FBH8098B	FBB68N-□-□□	BT50 -	MD80F - 100	98 (120)	150 (172)	171	144	8.3
FBH1920B	FBB20N-□-□□		MD19F - 85	20 (24)	26 (30)	118	80	5.2
FBH2526B	FBB26N-□-□□	MD25F - 105R	26 (32)	34 (40)	142	59	5.8	
FBH3233B	FBB33N-□-□□	MD32F - 110R	33 (40)	43 (50)	151	77	6	
FBH4042B	FBB42N-□-□□	MD40F - 195R	42 (50)	54 (62)	242	130	6.3	
FBH5053B	FBB53N-□-□□	MD50F - 225R	53 (65)	70 (82)	282	182	6.6	
FBH6368B	FBB68N-□-□□	MD63F - 230R	68 (90)	100 (122)	301	220	7.2	
FBH6398B	FBB68N-□-□□	MD63F - 195R	98 (120)	150 (172)	266	191	8.5	
FBH8098B	FBB68N-□-□□	MD80F - 175	98 (120)	150 (172)	246	208	12.8	

Partes 160

• Sistema de lubricación interno disponible

- Los FBB se dividen en dos tipos: Tipo normal: FBB□□N, Tipo escalable: FBB□□N-1
También están las otras opcionales para su inserción Tipo: FBB□□N-□-C09 or T11
FBB□□N, FBB□□N-1: TPGT, TPGW0802□□L
FBB□□N-□-C: CCMT, CCGT0602□□L
FBB□□N-□-C09: CCMT, CCGT09T3□□L
FBB□□N-□-T11: TPGT1103□□L

FBH

FBH1920B

Modelo Nuevo

Cabeza de micro mandrinado

Código	Rango Boreador ØD		L	Escala del rango ajustable del anillo según revolución	MD No.	kg
	Min	Max				
FBH - 1920B	20	26 (30)	33	Ø0.4 mm	MD1911	0.06
2526B	26	34 (40)	37	Ø0.4 mm	MD2514	0.12
3233B	33	43 (50)	41	Ø0.5 mm	MD3218	0.24
4042B	42	54 (62)	47	Ø0.5 mm	MD4022	0.41
5053B	53	70 (82)	57	Ø0.6 mm	MD5028	0.8
6368B	68	100 (122)	71	Ø0.8 mm	MD6336	1.7
6398B	98	150 (172)	71	Ø0.8 mm	MD6336	2.35

• El stock de las distintas partes de herramientas de mandrinado se gestiona por separado

• (): Max. Diámetro de mandrinado de herramientas con extensión



S-FBH/B

Cabeza de micro mandrinado pequeña

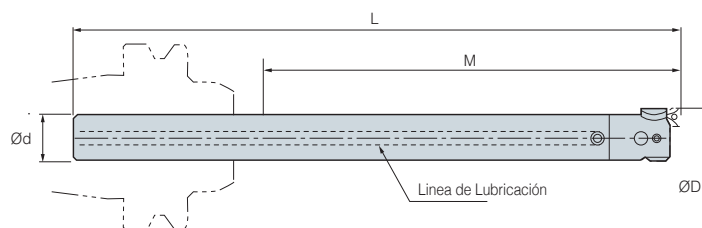

Código	Rango Boreador ØD	Diam del Zanco ød		L	M	Código			kg	
		Min	Max			Zanco Básico	Cabeza para/ Boreado	Cartucho		
S19W -	FBH20B - 120	19	20	26	190	120	S19W-MD19F-157	FBH1920B	FBB20N	0.6
	140	19	20	26	210	140	S19W-MD19F-177	FBH1920B	FBB20N	0.7
	160	19	20	26	230	160	S19W-MD19F-197	FBH1920B	FBB20N	0.8
S25W -	FBH26B - 150	25	26	34	235	150	S25W-MD25F-197.5	FBH2526B	FBB26N	1.4
	175	25	26	34	260	175	S25W-MD25F-222.5	FBH2526B	FBB26N	1.6
	200	25	26	34	285	200	S25W-MD25F-247.5	FBH2526B	FBB26N	2
S32W -	FBH33B - 180	32	33	43	280	180	S32W-MD32F-239	FBH3233B	FBB33N	2.8
	240	32	33	43	340	240	S32W-MD32F-299	FBH3233B	FBB33N	3.5
S19 -	FBH20B - 40	19	20	26	110	40	S19-MD19F-77	FBH1920B	FBB20N	0.1
	80	19	20	26	150	80	S19-MD19F-117	FBH1920B	FBB20N	0.2
S25 -	FBH26B - 50	25	26	34	135	50	S25-MD25F-97.5	FBH2526B	FBB26N	0.4
	100	25	26	34	185	100	S25-MD25F-147.5	FBH2526B	FBB26N	0.6
S32 -	FBH33B - 90	32	33	43	190	90	S32-MD32F-149	FBH3233B	FBB33N	1.1
	120	32	33	43	220	120	S32-MD32F-179	FBH3233B	FBB33N	1.2

• Sistema de lubricación interno disponible

S-FBH

Cabeza de micro mandrinado "mini"

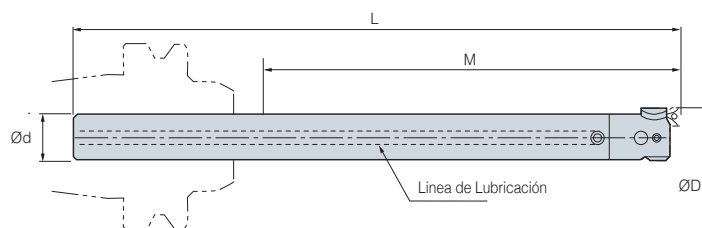

Código	Rango Boreador ØD	Diam del Zanco ød		L	M	Código			kg	
		Min	Max			Zanco Básico	Cabeza para/ Boreado	Cartucho		
S14W	FBH15 85	14	15	18	155	85	S14W-M6-123	FBH15	FBB15-C	0.2
	FBH15 110	14	15	18	180	110	S14W-M6-148	FBH15	FBB15-C	0.3
S16W	FBH18 95	16	18	22	165	95	S16W-M8-128	FBH18	FBB15-C	0.3
	FBH18 125	16	18	22	195	120	S16W-M8-158	FBH18	FBB15-C	0.4
S14	FBH15 40	14	15	18	110	40	S14-M6-78	FBH15	FBB15-C	0.1
S16	FBH18 45	16	18	22	115	45	S16-M8-78	FBH18	FBB15-C	0.1

• Sistema de lubricación interno disponible



Partes

Piezas de Refacción		
Tipo (FBH)	Tornillo de cierre	Tornillo Brida
FBH1920B	BTF0404	BXC0304
FBH2526B	BTF0505	BXC0405
FBH3233B	BTF0606	BXC0506
FBH4042B	BTF0808	BXC0610
FBH5053B	BTF0812	BXC0610
FBH6368B	BTF1016	BXC0810
FBH6398B	BTF1012	BXC0810
FBH8098B	BTF1014	BXC0810

FBB Cartucho (Modelo Nuevo)

Código	Rango de Boreo	Insertos	Cabeza Micro Boreado	Perno de Sujeción
FBB15C	Ø15~Ø18 mm	CCET0301-□□L	FTNA01633	BFTX02506N
	Ø18~Ø22 mm			
FBB20N	Ø20~Ø26 mm	TPGT0802□□L/TPGW0802□□	BFTX0204A	BXC0304
FBB20N-C		CCET0401□□L	BFTX0204N	
FBB20N-1	Ø24~Ø30 mm	TPGT0802□□L/TPGW0802□□	BFTX0204A	
FBB20N-1-C		CCET0401□□L	BFTX0204N	
FBB26N	Ø26~Ø34 mm	TPGT0802□□L/TPGW0802□□	BFTX0204A	BXC0405
FBB26N-C		CCET0401□□L	BFTX0204N	
FBB26N-1	Ø32~Ø40 mm	TPGT0802□□L/TPGW0802□□	BFTX0204A	
FBB26N-1-C		CCET0401□□L	BFTX0204N	
FBB33N	Ø33~Ø43 mm	TPGT0802□□L/TPGW0802□□	BFTX0204A	BXC0506
FBB33N-C		CCMT0602□□/CCGT0602□□	BFTX02506N	
FBB33N-1	Ø41~Ø50 mm	TPGT0802□□L/TPGW0802□□	BFTX0204A	
FBB33N-1-C		CCMT0602□□/CCGT0602□□L	BFTX02506N	
FBB42N	Ø42~Ø54 mm	TPGT0802□□L/TPGW0802□□	BFTX0204A	BXC0610
FBB42N-		CCMT0602□□/CCGT0602□□L	BFTX02506N	
FBB42N-11	Ø50~Ø62 mm	TPGT1103□□L	BFTX0307A	
FBB42N-1		TPGT0802□□L/TPGW0802□□	BFTX0204A	
FBB42N-1-C	Ø50~Ø62 mm	CCMT0602□□/CCGT0602□□L	BFTX02506N	
FBB42N-1-T11		TPGT1103□□L	BFTX0307A	
FBB53N	Ø53~Ø70 mm	TPGT0802□□L/TPGW0802□□	BFTX0204A	BXC0810
FBB53N-C		CCMT0602□□/CCGT0602□□L	BFTX02506N	
FBB53N-11	Ø65~Ø82 mm	TPGT1103□□L	BFTX0307A	
FBB53N-1		TPGT0802□□L/TPGW0802□□	BFTX0204A	
FBB53N-1-C		CCMT0602□□/CCGT0602□□L	BFTX02506N	
FBB53N-1-C09		CCMT09T3□□/CCGT09T3□□L	BFTX0409N	
FBB53N-1-T11	Ø90~Ø122 mm	TPGT1103□□L	BFTX0307A	
FBB68N		TPGT0802□□L/TPGW0802□□	BFTX0204A	
FBB68N-C	Ø98~Ø150 mm	CCMT09T3□□/CCGT09T3□□L	BFTX0409N	
FBB68N-11		TPGT1103□□L	BFTX0307A	
FBB68N-1	Ø90~Ø122 mm	TPGT0802□□L/TPGW0802□□	BFTX0204A	
FBB68N-1-C09		CCMT09T3□□/CCGT09T3□□L	BFTX0409N	
FBB68N-1-T11		TPGT1103□□L	BFTX0307A	



Para mandrinado en desbaste

TBC

- Amplia gama para mandrinado para diámetro grande - Ø130~Ø540 mm
- Estructura estable frente a la carga de corte - Ensamblaje mediante estructura de cola de milano
- Intercambiable con FBC - Con cabeza de mandrinar y raíl común, cartucho diferente
- Peso ligero (reducido en un 5%~20%)
- Diversos ángulos de aproximación del cartucho: 15°, 45°



➤ Sistema de codificación

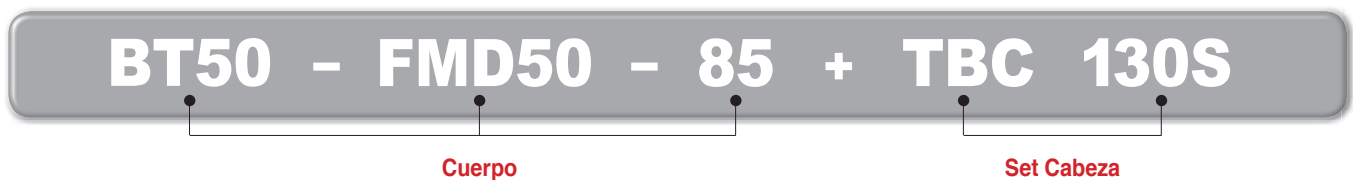

➤ Estructura TBC

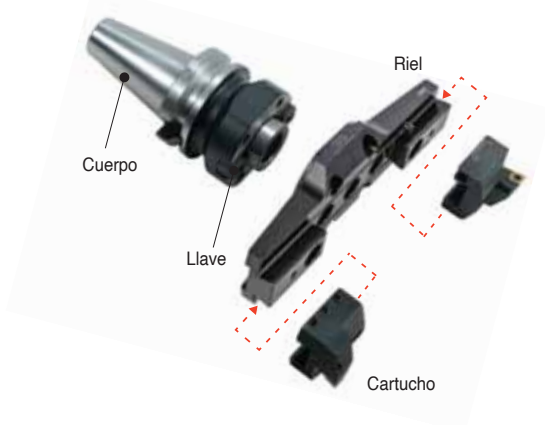

Cartucho: BCC1348
 Inserto: CCMT1204□□
 CNMG1204□□

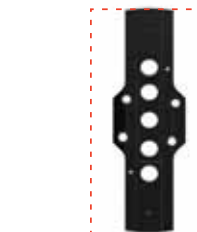

Menor peso y más margen para la evacuación de viruta



Resistencia y peso mejorados

➤ TBC condiciones de corte

Pieza de trabajo	Grados (HRC)	Condiciones de corte		
		Tipo (Grados)	Velocidad de corte (m/min)	Avance por Revolución f (mm/rev)
Todos	ADC12	"N"Material	"N"Material	0.1
Acero suave	SS41 (HB160)	P Material	P Material	0.1
Acero	S45C (H250)	P Material	P Material	0.1
Acero Inoxidable	SUS304	M Material	M Material	0.1
Fundicion	FC25 (HB250)	K Material	K Material	0.1

➤ Rango Mandrinado

Grados	Dia (Ø)		Cuerpo	Set Cabeza	Inserto
	min	max			
TBC130	130	180	FMD50	TBC130S	CCMT1204□□
TBC175	175	225	FMD50	TBC175S	CCMT1204□□
TBC220	220	270	FMD50	TBC220S	CCMT1204□□
TBC265	265	315	FMD50	TBC265S	CCMT1204□□
TBC310	310	390	FMD50	TBC310S	CCMT1204□□
TBC385	385	465	FMD50	TBC385S	CCMT1204□□
TBC460	460	540	FMD50	TBC460S	CCMT1204□□



Serie FBC

Para mandrinado de terminación

FBC

- Amplia gama para mandrinado para diámetro grande - Ø130 ~ Ø540 mm
- Intercambiable con TBC
 - Con cabeza de mandrinar y raíl común, cartucho diferente [microcartucho + bloque de equilibrado]
- Varias placas dependiendo del bite
 - Placas aplicables: CCMT09T3/1204, TPMT1103 (Cermet, cBN, PCD)



➤ Sistema de codificación

BT50 – FMD50 – 85 + FBC 130S

Cuerpo

Set Cabeza

➤ Estructura FBC

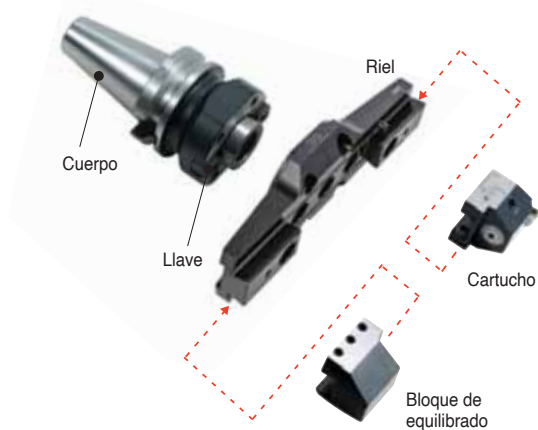

Cartucho
FCC130



Bloque de equilibrado
FCB130



Inserto
CCGT09T3□□
CCMT1204□□
TPGT1103□□

➤ FBC condiciones de corte

Grados	Dia (Ø)		Set Cabeza	Inserto
	min	max		
FBC130	130	180	FBC130S (TBR130+FCC130+FCB130)	
FBC175	175	225	FBC175S (TBR175+FCC130+FCB130)	
FBC220	220	270	FBC220S (TBR220+FCC130+FCB130)	FBB130-C09 (CCMT09T3□□, CCGT09T3□□)
FBC265	265	315	FBC265S (TBR265+FCC130+FCB130)	FBB130-C12 (CCMT1204□□)
FBC310	310	390	FBC310S (TBR310+FCC310+FCB310)	FBB130-T11 (TPMT1103□□,TPGT1103□□L)
FBC385	385	465	FBC385S (TBR385+FCC310+FCB310)	
FBC460	460	540	FBC460S (TBR460+FCC310+FCB310)	



TBC, FBC

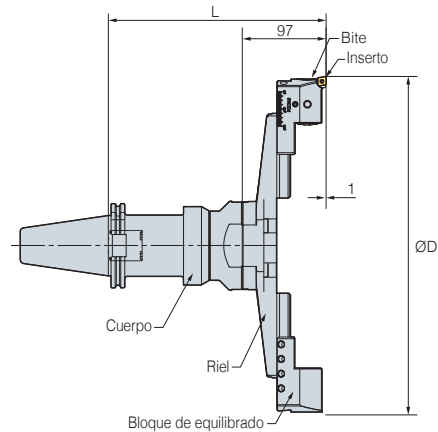

		Código								Rango Boreador	
Cuerpo	kg	Mandrinado: desbaste (TBC)			Mandrinado: acabado (FBC)					Min	Max
		Set Cabeza (Riel+Cartucho)	L	kg	Set Cabeza (Riel+Cartucho+Bloque de equilibrado)	L	kg				
BT50 - FMD50 -	85	5.9	TBC130S (TBR130+BCC1348)	175	3.5	FBC130S (TBR130+FCC130+FCB130)	182	3.8	130	180	
	155	7.9	TBC130S (TBR130+BCC1348)	245	3.5	FBC130S (TBR130+FCC130+FCB130)	252	3.8	130	180	
	205	9.7	TBC130S (TBR130+BCC1348)	295	3.5	FBC130S (TBR130+FCC130+FCB130)	302	3.8	130	180	
	255	10.4	TBC130S (TBR130+BCC1348)	345	3.5	FBC130S (TBR130+FCC130+FCB130)	352	3.8	130	180	
	85	5.9	TBC175S (TBR175+BCC1348)	175	3.9	FBC175S (TBR175+FCC130+FCB130)	182	4.1	175	225	
	155	7.9	TBC175S (TBR175+BCC1348)	245	3.9	FBC175S (TBR175+FCC130+FCB130)	252	4.1	175	225	
	205	9.7	TBC175S (TBR175+BCC1348)	295	3.9	FBC175S (TBR175+FCC130+FCB130)	302	4.1	175	225	
	255	10.4	TBC175S (TBR175+BCC1348)	345	3.9	FBC175S (TBR175+FCC130+FCB130)	352	4.1	175	225	
	85	5.9	TBC220S (TBR220+BCC1348)	175	4.3	FBC220S (TBR220+FCC130+FCB130)	182	4.5	220	270	
	155	7.9	TBC220S (TBR220+BCC1348)	245	4.3	FBC220S (TBR220+FCC130+FCB130)	252	4.5	220	270	
	205	9.7	TBC220S (TBR220+BCC1348)	295	4.3	FBC220S (TBR220+FCC130+FCB130)	302	4.5	220	270	
	255	10.4	TBC220S (TBR220+BCC1348)	345	4.3	FBC220S (TBR220+FCC130+FCB130)	352	4.5	220	270	
	85	5.9	TBC265S (TBR265+BCC1348)	175	4.5	FBC265S (TBR265+FCC130+FCB130)	182	4.6	265	315	
	155	7.9	TBC265S (TBR265+BCC1348)	245	4.5	FBC265S (TBR265+FCC130+FCB130)	252	4.6	265	315	
	205	9.7	TBC265S (TBR265+BCC1348)	295	4.5	FBC265S (TBR265+FCC130+FCB130)	302	4.6	265	315	
	255	10.4	TBC265S (TBR265+BCC1348)	345	4.5	FBC265S (TBR265+FCC310+FCB310)	352	4.6	265	315	
	85	5.9	TBC310S (TBR310+BCC1354)	175	5.5	FBC310S (TBR310+FCC310+FCB310)	182	5.5	310	390	
	155	7.9	TBC310S (TBR310+BCC1354)	245	5.5	FBC310S (TBR310+FCC310+FCB310)	252	5.5	310	390	
	205	9.7	TBC310S (TBR310+BCC1354)	295	5.5	FBC310S (TBR310+FCC310+FCB310)	302	5.5	310	390	
	255	10.4	TBC310S (TBR310+BCC1354)	345	5.5	FBC310S (TBR310+FCC310+FCB310)	352	5.5	310	390	
85	5.9	TBC385S (TBR385+BCC1354)	175	5.8	FBC385S (TBR385+FCC310+FCB310)	182	5.8	385	465		
155	7.9	TBC385S (TBR385+BCC1354)	245	5.8	FBC385S (TBR385+FCC310+FCB310)	252	5.8	385	465		
205	9.7	TBC385S (TBR385+BCC1354)	295	5.8	FBC385S (TBR385+FCC310+FCB310)	302	5.8	385	465		
255	10.4	TBC385S (TBR385+BCC1354)	345	5.8	FBC385S (TBR385+FCC310+FCB310)	352	5.8	385	465		
85	5.9	TBC460S (TBR460+BCC1354)	175	12.8	FBC460S (TBR460+FCC310+FCB310)	182	12.8	460	540		
155	7.9	TBC460S (TBR460+BCC1354)	245	12.8	FBC460S (TBR460+FCC310+FCB310)	252	12.8	460	540		
205	9.7	TBC460S (TBR460+BCC1354)	295	12.8	FBC460S (TBR460+FCC310+FCB310)	302	12.8	460	540		
255	10.4	TBC460S (TBR460+BCC1354)	345	12.8	FBC460S (TBR460+FCC310+FCB310)	352	12.8	460	540		

• Cartuchos de mandrinar a encarar por separado



FBB Cartuchos (Para FBC)



(mm)

Código	Inserto	
FBB130 -	C09	CCMT09T3□□, CCGT09T3□□
	C12	CCMT1204□□
	T11	TPMT1103□□, TPGT1103□□

• Los cartuchos TBC y DBC con ángulo de punta de 15°/45° se pueden comprar por pedido (base de 45°)

Partes

División	Piezas de Refacción								
	Básico								
	Riel	Cartucho	Cartucho	Tornillo Sujeción	Tornillo Sujeción	Block de Balance	Llave	Tornillo Sujeción	Llave
Tipo									
TBC130S	TBR130	BCC1348	-	BX0820	BT0645	-	LW-3	BFTX0511N	TW20
TBC175S	TBR175								
TBC220S	TBR220								
TBC265S	TBR265								
TBC310S	TBR310	BCC1354 (BCN1354)	FCC130	BT0660	FCB130	LW-3	-	-	-
TBC385S	TBR385								
TBC460S	TBR460	-	FCC310	BT0660	FCB310	LW-3	-	-	-
FBC130S	TBR130								
FBC175S	TBR175								
FBC220S	TBR220								
FBC265S	TBR265								
FBC310S	TBR310								
FBC385S	TBR385	FCC310	BT0660	FCB310	LW-3	-	-	-	
FBC460S	TBR460								



BT-DBC

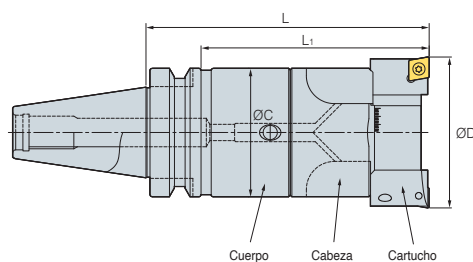

(mm)

Código				Rango Boreador ØD		L	Profundidad máxima de boreo
Set Cabeza (Cabeza, riel & cartucho)	kg	Cuerpo (Cono Básico)	kg	Min	Max		
DBC2528S	0.3	BT30-MD25F-90R	0.4	28	35	140	93
DBC3235S	0.4	BT30-MD32F-80R	0.4	35	46	145	114
DBC4046S	0.6	BT30-MD40F-80R	0.5	46	58	150	119
DBC5058S	1.1	BT30-MD50F-70	0.8	58	74	150	128
DBC2528S	0.3	BT40-MD25F-105R	1.9	28	35	165	100
DBC3235S	0.4	BT40-MD32F-115R	2.4	35	46	180	110
DBC4046S	0.6	BT40-MD40F-110R	2.7	46	58	180	130
DBC5058S	1.1	BT40-MD50F-100R	2.7	58	74	180	130
DBC6374S	2.0	BT40-MD63F-90	3.6	74	94	180	150
DBC8094S	3.5	BT40-MD80F-100	4.8	94	120	200	173
DBC2528S	0.3	BT50-MD25F-120R	4.7	28	35	180	100
DBC3235S	0.4	BT50-MD32F-235R	5.3	35	46	300	180
DBC4046S	0.6	BT50-MD40F-230R	5.6	46	58	300	250
DBC5058S	1.1	BT50-MD50F-250R	6.5	58	74	330	280
DBC6374S	2.0	BT50-MD63F-240R	8.4	74	94	330	280
DBC8094S	3.5	BT50-MD80F-175	9.5	94	120	275	225
DBC120S	5.3	BT50-MD80F-175	9.5	120	175	275	235

Partes

División	Piezas de Refacción								
	Básico								
	Cabeza	Pasador	Perno de Sujeción	Llave	Cartucho	Set Tornillo	Llave	Tornillo Sujeción	Llave
Tipo									
DBC2528S	DBC2528	SP0308	BX0415	LW-3	BCC28	BT0306	LW-1.5	FTKA02565	TRX7
DBC3235S	DBC3235	SP0410	BX0515	LW-4	BCC35	BT0308			
DBC4046S	DBC4046	SP0516	BX0620	LW-5	BCC46	BT0410	LW-2	FTNA0408	TRX15
DBC5058S	DBC5058	SP0616			BCC58	BT0412			
DBC6374S	DBC6374	SP1018	BX0830	LW-6	BCC74	BT0516	LW-2.5	BFTX0511N	TRX20
DBC8094S	DBC8094	SP1020	BX1035	LW-8	BCC94	BT0620	LW-3		
DBC120S	DBC120N	SP1020	BX0830	LW-6.0	BCC120	BT0830	LW-4.0	BFTX0511N	TRX20



BT-KMB

Micro Boreado

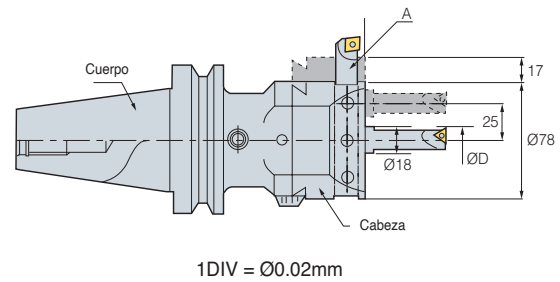

(mm)

Código	Cabeza (Modular)	Barra de mandrinado	L	L ₁	
BT40 - MD63F - 64	KMB6336	BB18-□(S)	141	64	5.5
BT50 - MD63F - 75	KMB6336	BB18-□(S)	152	75	7.0

Cabeza	Cartucho	MD NO.	L	
KMB6336	BB18-□(S)	BT□□-MD63F	77	2.2

• Sistema de lubricación interno es opcional

Barra de mandrinado: Tipo BB (Para KMB)

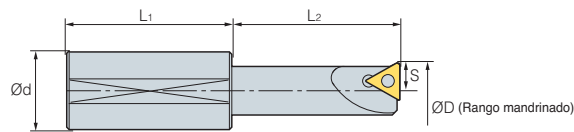

(mm)

Código	Rango mandrinado (Centro)		Rango mandrinado (Lado)		S	L ₁	L ₂	Insertoso	Tornillo Insertoso	
	Min	Max	Min	Max						
BB	18-7(S)	7	40	43	91	3.5	30	30	TBGT0601□□L	BFTX0204A
	18-9(S)	9	42	45	93	4.5	30	40	TPGT0802□□L	BFTX0204A
	18-11(S)	11	44	47	95	5.5	30	45	TPGT1103□□L	BFTX0307A
	18-13(S)	13	46	49	97	6.5	40	45	TPGT1103□□L	BFTX0307A
	18-15(S)	15	48	51	99	7.5	40	50	TPGT1103□□L	BFTX0307A
	18-17(S)	17	50	53	101	8.5	40	50	TPGT1103□□L	BFTX0307A

Partes

División	Piezas de Refacción				
	Básico			Opcional	
	Cabeza para mandrinado	Tornillo de Sujecion	Llave	Barra Boreado	Cono Básico
Tipo					
KMB	KMB6336	BTT1620F	LW-8	BB18	MD63F



BT-SMB

Cabeza de mandrinado "micro"

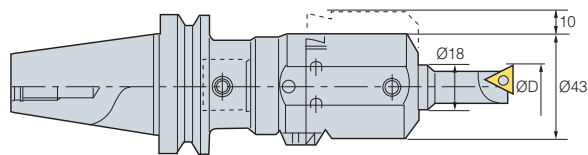

1DIV = Ø0.02mm

(mm)

Código	Cabeza (Modular)	Barra de mandrinado	L	L ₁	
BT40 - MD40F - 60	SMB4022	BB18-O(S)	122.5	60	2.8
BT50 - MD40F - 60	SMB4022	BB18-O(S)	122.5	60	5.4

Cabeza	Cartucho	MD NO.	L	
SMB4022	BB18-O(S)	BTOO-MD40T	62.5	0.6

• Sistema de lubricación interno no disponible

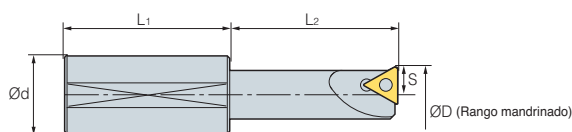
 Barra de mandrinado: Tipo BB (Para SMB)

(mm)

Código	Rango Boreador		S	L ₁	L ₂	Insertoso	Tornillo Insertoso	
	Min	Max						
BB	18-7(S)	7	27	3.5	30	30	TBGT0601□□L	BFTX0204A
	18-9(S)	9	29	4.5	30	40	TPGT0802□□L	BFTX0204A
	18-11(S)	11	31	5.5	30	45	TPGT1103□□L	BFTX0307A
	18-13(S)	13	33	6.5	40	45	TPGT1103□□L	BFTX0307A
	18-15(S)	15	35	7.5	40	50	TPGT1103□□L	BFTX0307A
	18-17(S)	17	37	8.5	40	50	TPGT1103□□L	BFTX0307A

 Partes

División	Piezas de Refacción				
	Básico			Opcional	
	Cabeza para mandrinado	Tornillo de Sujecion	Llave	Barra Boreado	Cono Básico
Tipo					
SMB	SMB4022	BTT1013F	LW-5	BB18	MD40F



BT-SMH

Cabeza de mandrinado "micro" (de alta precisión)

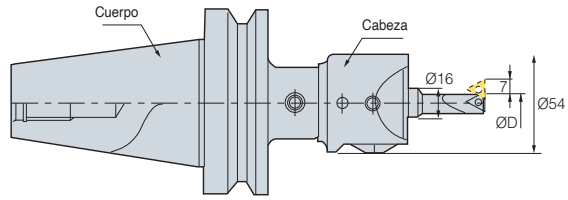

(mm)

Código	Cabeza (Modular)	Barra de mandrinado	L	L ₁	
BT40 - MD40F - 60	SMH4022	BB16-O(S)	109	60	3.0
BT50 - MD40F - 60	SMH4022	BB16-O(S)	109	60	6.0

Cabeza	Cartucho	MD NO.	L	
SMH4022	BB18-O(S)	BTOO-MD40F	49	2.7

• Sistema de lubricación interno no disponible

Barra de mandrinado: Tipo BB (Para SMH)

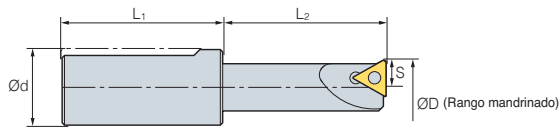

(mm)

Código	Rango Boreador ØD		S	L ₁	L ₂	Insertoso	Tornillo Insertoso	Llave
	Min	Max						
BB	16-5(S)	5.5 19	2.75	34	20	WBG0601□□L	BFTX0203A	TRX06
	16-7(S)	7 21	3.5	34	30	TBGT0601□□L	BFTX0204A	TRX06
	16-9(S)	9 23	4.5	34	40	TPGT0802□□L	BFTX0204A	TRX06
	16-11(S)	11 25	5.5	34	45	TPGT1103□□L	BFTX0307A	TRX10
	16-15(S)	15 29	7.5	34	50	TPGT1604□□L	BFTX0307A	TRX10
	16-19(S)	19 33	9.5	34	60	TPGT1103□□L	BFTX0410A	TRX15

Partes

División	Piezas de Refacción				
	Básico			Opcional	
	Cabeza para mandrinado	Tornillo de Sujecion	Llave	Barra de mandrinado	Cono Básico
Tipo					
SMH	SMH4022	BTT1013F	LW-5	BB16	MD40F



Versátil sistema de herramientas de conforme a las especificaciones FMS

Sistema Modular

- Sistema de herramientas versátil que cumple con la especificación FMS
- Combinación flexible de unidades de herramientas según condiciones del sujeto
- Unirse con un tornillo especialmente diseñado proporciona una alta precisión (error inferior a 5 μm) y una fácil separación para un solo paso
- Borde de corte del sistema de perforación alineado con la ranura de la llave de transmisión
- Precisión y rigidez correspondientes en comparación con el tipo de cuerpo único

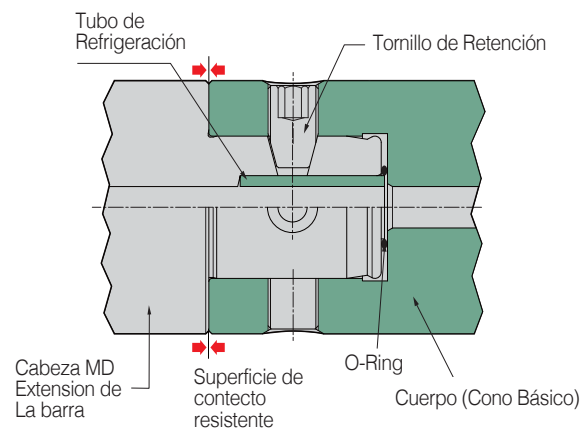
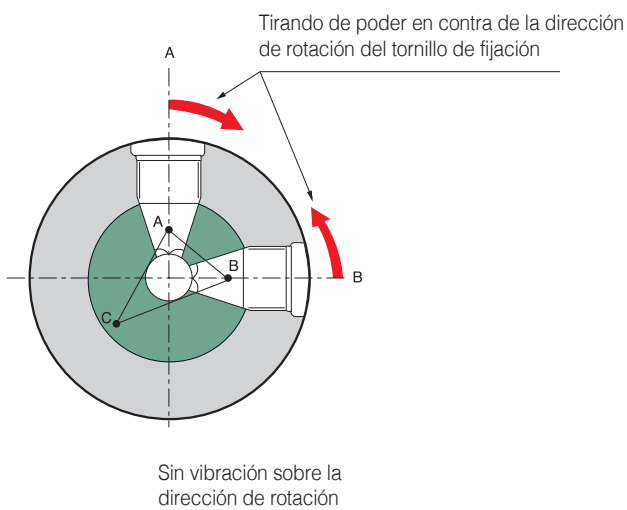

BT-MD

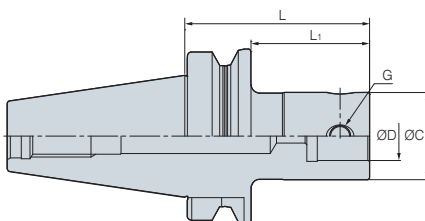

Fig. 1

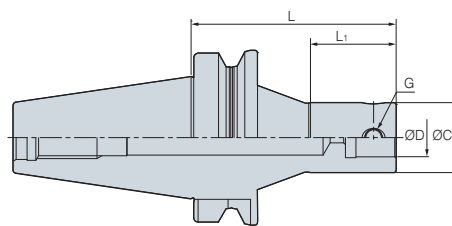



Fig. 2

(mm)

Código	ØC	ØD	L	L ₁	G		Fig.	
BT30 -	MD19F - 70	19	11	70	45	M5	0.4	1
	MD25F - 90	25	14	90	63	M6	0.3	1
	MD32F - 80	32	18	80	55	M8	0.4	1
	MD40F - 45	40	22	45	22	M8	0.4	1
	MD40F - 60	40	22	60	36	M10	0.5	1
	MD40F - 80	40	22	80	56	M10	0.5	1
	MD50F - 70	50	28	70	48	M12	0.8	3
BT40 -	MD19F - 70	19	11	70	40	M5	1.8	1
	MD25F - 95	25	14	95	63	M6	1.9	1
	MD25F - 105R	25	14	105	40	M6	1.9	2
	MD32F - 100	32	18	100	70	M8	2.3	1
	MD32F - 115R	32	18	115	45	M8	2.4	2
	MD40F - 60	40	22	60	31	M10	2.7	1
	MD40F - 110R	40	22	110	60	M10	2.7	2
	MD40F - 115	40	22	115	83	M10	2.7	1
	MD50F - 105	50	28	105	73	M12	2.7	1
	MD63F - 64	63	36	64	37	M16	3.3	1
	MD63F - 110	63	36	110	83	M16	3.6	1
	MD63F - 135	63	36	135	108	M16	4.6	1
	MD80F - 100	80	45	100	73	M16	4.8	3
BT50 -	MD19F - 85	19	11	85	44	M5	4.3	1
	MD25F - 105	25	14	105	62	M6	4.5	1
	MD25F - 120R	25	14	120	40	M6	4.7	2
	MD32F - 110	32	18	110	67	M8	5.1	1
	MD32F - 115R	32	18	115	45	M8	5.1	2
	MD32F - 235R	32	18	235	115	M8	5.3	2
	MD40F - 60	40	22	60	22	M10	5.0	1
	MD40F - 195	40	22	195	152	M10	5.4	1
	MD40F - 230R	40	22	230	180	M10	5.6	2
	MD50F - 125	50	28	125	82	M12	6.0	1
	MD50F - 225	50	28	225	182	M12	6.4	1
	MD50F - 250R	50	28	250	81	M12	6.5	2
	MD63F - 75	63	36	75	35	M16	6.0	1
	MD63F - 130	63	36	130	87	M16	6.8	1
	MD63F - 195	63	36	195	152	M16	8.0	1
	MD63F - 230	63	36	230	187	M16	8.4	1
	MD80F - 75	80	45	75	36	M16	9.1	1
	MD80F - 110	80	45	110	69	M16	9.4	1
	MD80F - 175	80	45	175	134	M16	9.5	1
	MD90F - 75	90	45	75	34	M16	9.3	1
MD90F - 145	90	45	145	104	M16	9.9	1	
MD90F - 195	90	45	195	154	M16	10.2	1	



 Piezas de refacción | 71

• Sistema de lubricación interno disponible • Disponible cuerpo de mandrinado a medida por encargo especial

HSK-MD

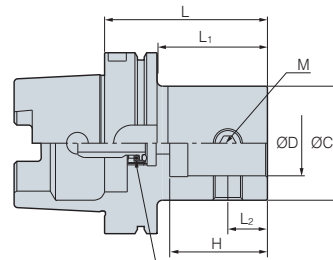



Tubo de Refrigeración (Opcional)

(mm)

Código	ØC	ØD	L	L ₁	L ₂	H	M	
HSK 63A -	MD19F - 60	19	11	60	34	6.5	15.5	M5
	MD25F - 60	25	14	60	31	8	18.5	M6
	MD32F - 65	32	18	65	31	11	23.5	M8
	MD40F - 70	40	22	70	41	13	29	M10
	MD50F - 85	50	28	85	58	17	36	M12
	MD63F - 95	63	36	95	69	22	54	M16

• Sistema de lubricación interno disponible

Partes

División	Piezas de Refacción	
	Básico	Opcional
	Tornillo de Sujecion	Llave
Tipo		
MD19F	BTT0506F	LW-2.5
MD25F	BTT0608F	LW-3
MD32F	BTT0810F	LW-4
MD40F	BTT1013F	LW-5
MD50F	BTT1215F	LW-6
MD63F	BTT1620F	LW-8
MD80F	BTT1626F	LW-8
MD90F	BTT1631F	LW-8



EXT

Barra extensión

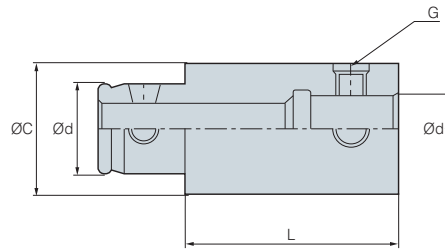

(mm)

Código	ØC	Ød	L	Ød ₁	G
EXT - 1930F	19	11	30	11	M5
1950F	19	11	50	11	M5
2530F	25	14	30	14	M6
2550F	25	14	50	14	M6
3235F	32	18	35	18	M8
3260F	32	18	60	18	M8
4040F	40	22	40	22	M10
4090F	40	22	90	22	M12
5050F	50	28	50	28	M12
50100F	50	28	100	28	M12
6360F	63	36	60	36	M16
63120F	63	36	120	36	M16
8070F	80	45	70	45	M16
80120F	80	45	120	45	M16
9080F	90	45	80	45	M16
90130F	90	45	130	45	M16

• Sistema de lubricación interno disponible



RDC

Barra de reducción

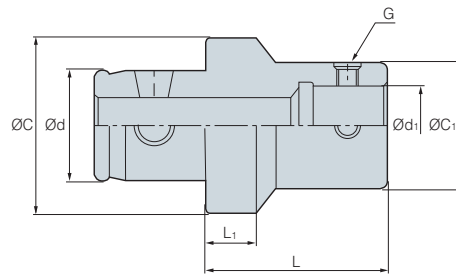

(mm)

Código	Ød	ØC1	Ød1	ØC	L	L ₁	G
RDC - 3225F	18	25	14	32	30	9	M6
4025F	22	25	14	40	30	9	M6
4032F	22	32	18	40	30	9	M8
5025F	28	25	14	50	30	9	M6
5032F	28	32	18	50	30	9	M8
5040F	28	40	22	50	40	10	M10
6325F	36	25	14	63	30	9	M6
6332F	36	32	18	63	30	9	M8
6340F	36	40	22	63	40	10	M10
6350F	36	50	28	63	45	10	M12
8032F	45	32	18	80	30	9	M6
8040F	45	40	22	80	40	10	M10
8050F	45	50	28	80	45	10	M12
8063F	45	63	36	80	50	13	M16

• Sistema de lubricación interno disponible

Partes

División	Piezas de Refacción		
	Básico		Opcional
	Tornillo de Sujeción	Pasador	Llave
Tipo			
MD19F	BTT0506F	-	LW-2.5
MD25F	BTT0608F	SP0308	LW-3
MD32F	BTT0810F	SP0410	LW-4
MD40F	BTT1013F	SP0516	LW-5
MD50F	BTT1215F	SP0616	LW-6
MD63F	BTT1620F	SP0818	LW-8
MD80F	BTT1626F	SP1020	LW-8
MD90F	BTT1631F	SP1020	LW-8





KORLOY Herramienta antivibración

KORLOY DAMPING PRO

- Diseño especial que proporciona un excelente efecto antivibración y está optimizado para el trabajo en voladizos
- Capaz de aumentar el avance en comparación con el eje estándar con un mecanizado estable
- Mayor vida útil de la herramienta y menos ruido
- Proporciona una solución para moldes, mecanizado de cavidades profundas y trabajo de servicio pesado

➤ Sistema de codificación

KDP	- BT50	- FMA25.4	- 260
KORLOY DAMPING PRO	Conicidad del eje BT Tipo HSK Tipo SK Tipo	FMA: JIS B4113 Fresa de planeado FMB: T-MAX Fresa de planeado/ Fresa de escuadrado FMC: T-MAX Fresa de planeado/ Fresa de escuadrado	Largo de línea de calibre

➤ Características



- Antivibración: Estructura antivibraciones de diseño exclusivo
- Material: Aleaciones de acero especiales
- Cuerpo antivibraciones: Con amortiguador de alta densidad
- Voladizo: Apto para 2D~5D
- Refrigeración: Dispone de refrigeración interna



BT Tipo



HSK Tipo



SK Tipo

Tamaño: Varios tipos y tamaños disponibles

➤ Comparación del tiempo de amortiguación de la vibración

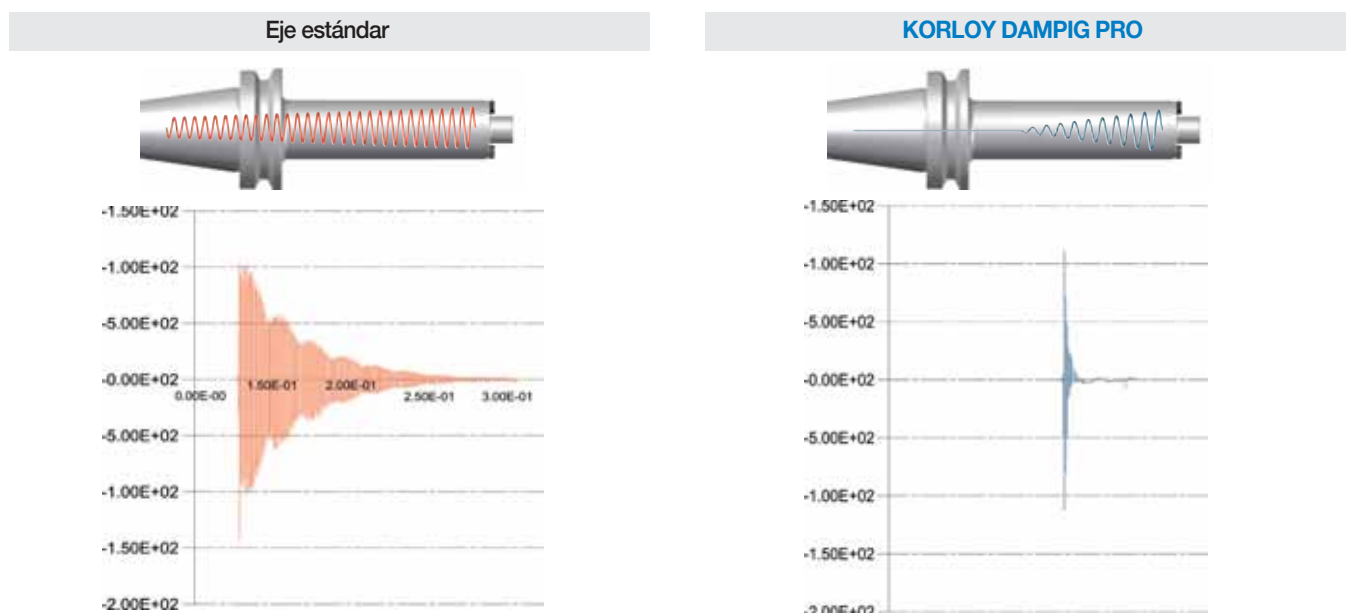

Evaluación del rendimiento

- **Condiciones de Corte:** f_z (mm/t) = 0.1
 vc (m/min) = 100
- **FRESA:** AMC4063HS 6 canales
- **Eje:** BT50-FMC22-210 Eje estándar
KDP-BT50-FMC22-210 Damping pro

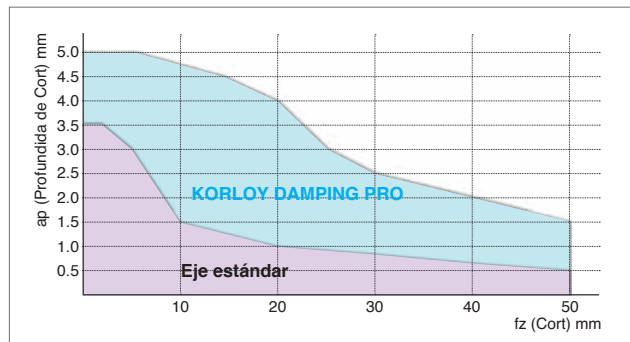

- **Condiciones de Corte:** f_z (mm/t) = 0.1
 vc (m/min) = 100
- **FRESA:** FMRC3063HRD-H 6 canales
- **Eje:** BT50-FMC22-210 Eje estándar
KDP-BT50-FMC22-210 Damping pro

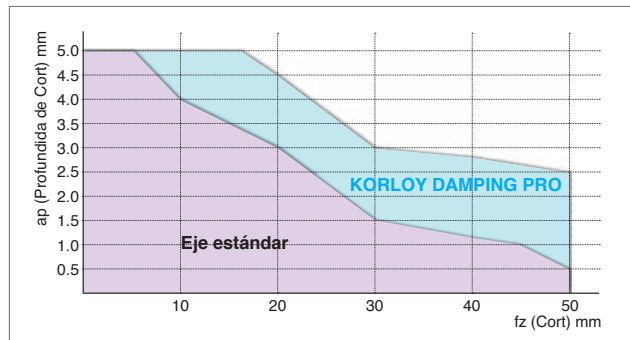

Ejemplo de aplicación

Mecanizado de moldes	Mecanizado con fresa de corte lateral	Refrentado de alta profundidad	Mecanizado por mandrinado de orificios profundos
Mejor productividad que con el eje estándar	Excelente rendimiento en el ranurado profundo	Mejor productividad y rugosidad superficial que con el eje estándar	Mejor rugosidad superficial y mecanizabilidad que con el eje estándar

Ejemplo de mecanizado con fresa de corte lateral

- Fallos en el tamaño y la rugosidad superficial debido a la vibración cuando se utiliza el eje estándar
- **Buen tamaño y rugosidad superficial usando DAMPING PRO**



- **Eje estándar**
Condiciones de Corte:
 vc (m/min) = 50
 f_z (mm/t) = 0.1
 ae (mm) = 20
- **DAMPING PRO**
Condiciones de Corte:
 vc (m/min) = 100
 f_z (mm/t) = 0.1
 ae (mm) = 20

Ejemplo de mecanizado de cigüeñal de tamaño grande

- Eje estándar: $ap = 2$ mm
- KORLOY DAMPING PRO: $ap = 4$ mm disponible
- **2 veces mejor productividad**



- **Eje estándar**
Condiciones de Corte:
 vc (m/min) = 100
 f_z (mm/t) = 0.15
 ap (mm) = 2
- **DAMPING PRO**
Condiciones de Corte:
 vc (m/min) = 100
 f_z (mm/t) = 0.15
 ap (mm) = 4

BT-FMA

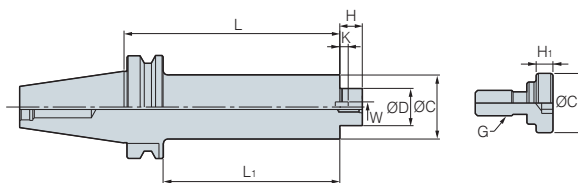

Fig. 1

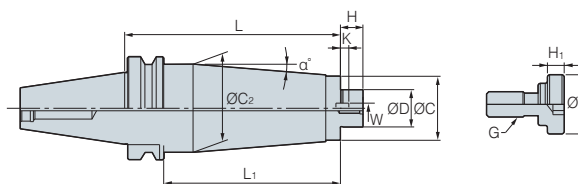

Fig. 2

(mm)

Código	Diámetro del Cortador	ØD	L	L ₁	ØC	ØC ₂	H	W	K	G	ØC ₁	H ₁	kg	Fig.	α°	
KDP-BT40 -	FMA25.4 - 210	80	25.4	210	183	50	60	22	9.5	5	M12	33	10	5.42	2	1
	FMA25.4 - 260	80	25.4	260	233	50	60	22	9.5	5	M12	33	10	6.5	2	1.1
	FMA31.75 -210	100	31.75	210	183	60	-	30	12.7	7	M16	40	10	5.94	1	-
	FMA31.75 -260	100	31.75	260	233	60	-	30	12.7	7	M16	40	10	7.25	1	-
KDP-BT50 -	FMA25.4 - 210	80	25.4	210	172	50	78	22	9.5	5	M12	33	10	9.63	2	4
	FMA25.4 - 260	80	25.4	260	222	50	78	22	9.5	5	M12	33	10	11.8	2	3
	FMA31.75 -210	100	31.75	210	172	60	85	30	12.7	7	M16	40	10	11.8	2	3
	FMA31.75 -260	100	31.75	260	222	60	85	30	12.7	7	M16	40	10	13.6	2	2.5

- El tipo A se usa para la fresa de planeado JIS B4113
- Los tipos B y C son ejes para la fresa de planeado y escuadrado T-MAX
- El peso (kg) que se muestra en el gráfico no incluye el peso de la fresa de planeado
 - La llave y el tornillo van juntos
 - La llave de tuercas se vende por separado

Partes

División	Piezas de Refacción				
	Básico				Opcional
	Cuña	Tornillo Sujeción	Tornillo Llave	Tornillo Llave	Llave
Tipo					
FMA25.4	K9.5(B)	MBA-M12	BX0412	BX1225	LW-10
FMA31.75	K12.7(D)	MBA-M16	BX0515	-	LW-14



BT-FMC

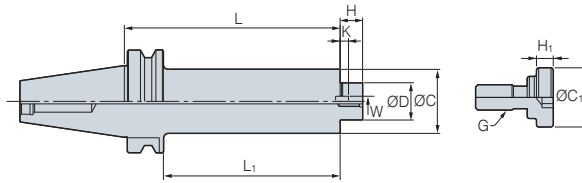

Fig. 1

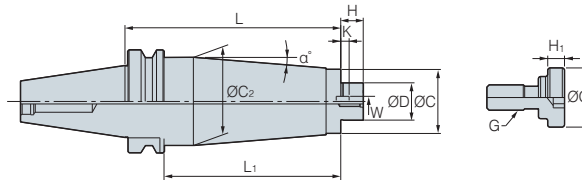

Fig. 2

														(mm)
Código	Diámetro del Cortador	ØD	L	L ₁	ØC	ØC ₂	H	W	K	G	kg	Fig.	α°	
KDP-BT40 -	FMC16 - 160	40	16	160	133	38	-	17	8	5	M8	2.45	1	-
	FMC22 - 210	50/63	22	210	183	48	4.95	19	10	5.6	M10	4.37	2	0.1
	FMC22 - 260	50/63	22	260	233	48	60	19	10	5.6	M10	6.3	2	1.5
	FMC27 - 210	80	27	210	183	60	-	21	12	6.3	M12	6	1	-
	FMC27 - 260	80	27	260	233	60	-	21	12	6.3	M12	7.25	1	-
KDP-BT50 -	FMC16 - 171	40	16	171	133	38	-	17	8	5	M8	5.1	1	-
	FMC22 - 210	50/63	22	210	172	48	49.5	19	10	5.6	M10	7.3	2	0.1
	FMC22 - 260	50/63	22	260	222	48	62	19	10	5.6	M10	10	2	1
	FMC27 - 210	80	27	210	172	60	78	21	12	6.3	M12	10.6	2	2.5
	FMC27 - 260	80	27	260	222	60	78	21	12	6.3	M12	12.6	2	2
	FMC27 - 320	80	27	320	282	60	78	21	12	6.3	M12	14.8	2	1
	FMC32 - 210	100	32	210	172	78	-	24	14	7	M16	11.7	1	-
	FMC32 - 260	100	32	260	222	78	-	24	14	7	M16	14.2	1	-
	FMC32 - 330	100	32	330	292	78	-	24	14	7	M16	16.6	1	-

- El tipo A se usa para la fresa de planeado JIS B4113
- Los tipos B y C son ejes para la fresa de planeado y escuadrado T-MAX
- El peso (kg) que se muestra en el gráfico no incluye el peso de la fresa de planeado
 - La llave y el tornillo van juntos
 - La llave de tuercas se vende por separado

Partes

División	Piezas de Refacción				
	Básico				Opcional
	Cuña	Tornillo Sujeción	Tornillo Llave	Tornillo Llave	Llave
Tipo					
FMC16	K8.0(A)	-	BX0310	BX0820	LW-6
FMC22	K10.0(C)	-	BX0412	BX1030	LW-8
FMC27	K12.0	MBA-M12	BX0616	-	LW-10
FMC32	K14.0	MBA-M16	BX0820	-	LW-14



HSK-FMA

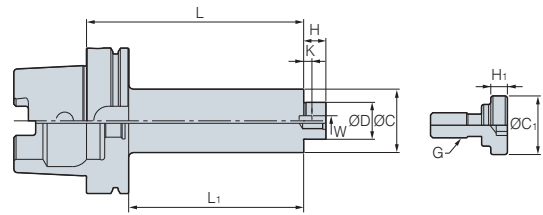

Fig. 1

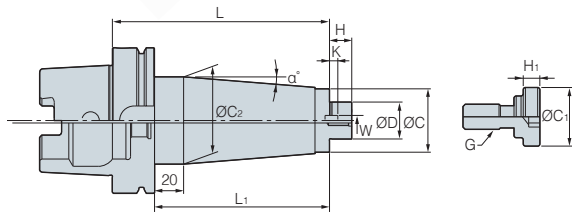

Fig. 2

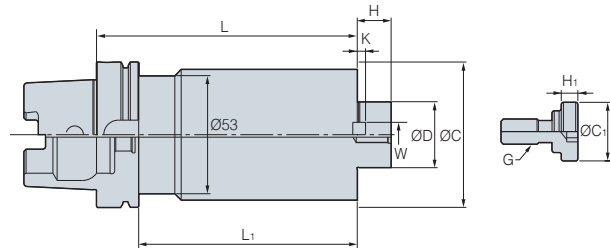

Fig. 3

Código		Diámetro del Cortador	ØD	L	L ₁	ØC	ØC ₂	H	W	K	G	ØC ₁	H ₁	kg	Fig.	α°
KDP-HSK63 -	FMA25.4 - 210	80	25.4	210	184	50	53	22	9.5	5	M12	33	10	4.55	3	0.1
	FMA25.4 - 260	80	25.4	260	234	50	53	22	9.5	5	M12	33	10	5.6	3	0.1
	FMA31.75 - 210	100	31.75	210	184	60	-	30	12.7	7	M16	40	10	5.52	2	-
	FMA31.75 - 260	100	31.75	260	234	60	-	30	12.7	7	M16	40	10	6.9	2	-
KDP-HSK100 -	FMA25.4 - 210	80	25.4	210	181	50	78	22	9.5	5	M12	33	10	8.32	3	4
	FMA25.4 - 260	80	25.4	260	231	50	78	22	9.5	5	M12	33	10	10.5	3	3
	FMA31.75 - 210	100	31.75	210	181	60	85	30	12.7	7	M16	40	10	10.9	3	3
	FMA31.75 - 260	100	31.75	260	231	60	85	30	12.7	7	M16	40	10	12.8	3	2.5

(mm)

- El tipo A se usa para la fresa de planeado JIS B4113
- Los tipos B y C son ejes para la fresa de planeado y escuadrado T-MAX
- El peso (kg) que se muestra en el gráfico no incluye el peso de la fresa de planeado
- La llave y el tornillo van juntos
- La llave de tuercas se vende por separado

Partes

División	Piezas de Refacción				
	Básico				Opcional
	Cuña	Tornillo Sujeción	Tornillo Llave	Tornillo Llave	Llave
Tipo					
FMA25.4	K9.5(B)	MBA-M12	BX0412	BX1230	LW-10
FMA31.75	K12.7(D)	MBA-M16	BX0515	-	LW-14



HSK-FMC

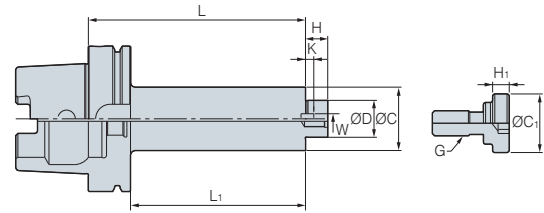

Fig. 1

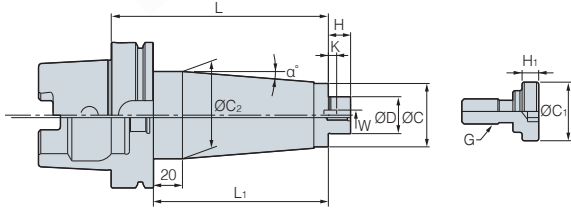

Fig. 2

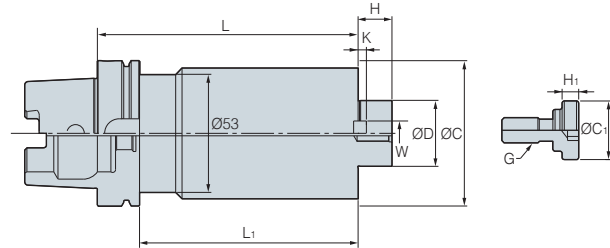

Fig. 3

Código	Diámetro del Cortador	ØD	L	L ₁	ØC	ØC ₂	H	W	K	G	kg	Fig.	α°	
KDP-HSK63 -	FMC16 - 160	40	16	160	134	38	-	17	8	5	M8	2.10	1	-
	FMC22 - 210	50/63	22	210	184	48	4.95	19	10	5.6	M10	3.82	1	0.1
	FMC22 - 260	50/63	22	260	234	48	62	19	10	5.6	M10	6.14	3	1.6
	FMC27 - 210	80	27	210	184	60	-	21	12	6.3	M12	5.53	2	-
	FMC27 - 260	80	27	260	234	60	-	21	12	6.3	M12	6.83	2	-
KDP-HSK100 -	FMC16 - 160	40	16	160	131	38	-	17	8	5	M8	3.45	1	-
	FMC22 - 210	50/63	22	210	181	48	49.5	19	10	5.6	M10	4.60	3	0.1
	FMC22 - 260	50/63	22	260	231	48	62	19	10	5.6	M10	8.10	3	1
	FMC27 - 210	80	27	210	181	60	78	21	12	6.3	M12	8.44	3	2.5
	FMC27 - 260	80	27	260	231	60	78	21	12	6.3	M12	10.40	3	2
	FMC27 - 320	80	27	320	291	60	78	21	12	6.3	M12	13.60	3	1
	FMC32 - 210	100	32	210	181	78	-	24	14	7	M16	10.20	1	-
	FMC32 - 260	100	32	260	231	78	-	24	14	7	M16	13.00	1	-
FMC32 - 330	100	32	330	301	78	-	24	14	7	M16	15.43	1	-	

- El tipo A se usa para la fresa de planeado JIS B4113
- Los tipos B y C son ejes para la fresa de planeado y escuadrado T-MAX
- El peso (kg) que se muestra en el gráfico no incluye el peso de la fresa de planeado
 - La llave y el tornillo van juntos
 - La llave de tuercas se vende por separado

Partes

División	Piezas de Refacción				
	Básico				Opcional
	Cuña	Tornillo Sujeción	Tornillo Llave	Tornillo Llave	Llave
Tipo					
FMC16	K8.0(A)	-	BX0310	BX0820	LW-6
FMC22	K10.0(C)	-	BX0412	BX1030	LW-8
FMC27	K12.0	MBA-M12	BX0616	-	LW-10
FMC32	K14.0	MBA-M16	BX0820	-	LW-14



SK-FMC

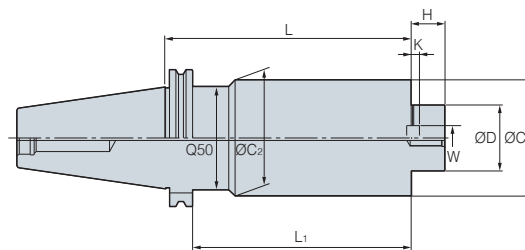

Fig. 1

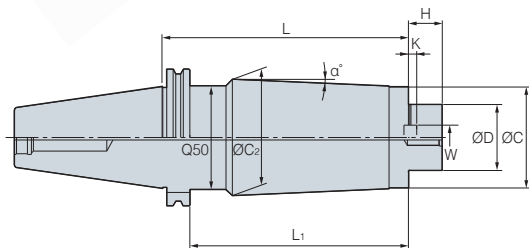

Fig. 2

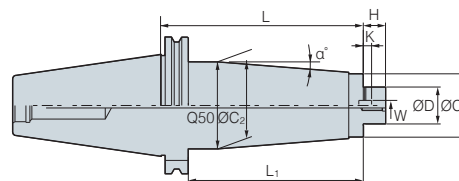



Fig. 3

(mm)

Código	Diámetro del Cortador	ØD	L	L ₁	ØC	ØC ₂	H	W	K	G		Fig.	α°		
KDP-SK40 - FMC22 -	210	50/63	22	210	183.0	48	49.5	19	10	4.4	M10	4.4	3	0.1	
	260	50/63	22	260	233.0	48	60	19	10	5.6	M10	6.2	2	1.4	
	FMC27 -	210	80	27	210	183.0	60	60	21	12	6.3	M12	5.9	1	-
	FMC27 -	260	80	27	260	233.0	60	60	21	12	6.3	M12	7.2	1	-
KDP-SK50 - FMC22 -	210	50/63	22	210	190.9	48	49.5	19	10	5.6	M10	6.4	3	0.1	
	260	50/63	22	260	240.9	48	62	19	10	5.6	M10	9.1	3	1	
	FMC27 -	210	80	27	210	190.9	60	78	21	12	6.3	M12	9.8	3	2.5
	FMC27 -	260	80	27	260	240.9	60	78	21	12	6.3	M12	12.4	3	1.8
	FMC27 -	320	80	27	320	300.9	60	78	21	12	6.3	M12	14.5	3	1.2
	FMC32 -	210	100	32	210	190.9	78	-	24	14	7	M16	11.5	1	-
	FMC32 -	260	100	32	260	240.9	78	-	24	14	7	M16	14	1	-
FMC32 -	330	100	32	330	310.9	78	-	24	14	7	M16	16.4	1	-	

- El tipo A se usa para la fresa de planeado JIS B4113
- Los tipos B y C son ejes para la fresa de planeado y escuadrado T-MAX
- El peso (kg) que se muestra en el gráfico no incluye el peso de la fresa de planeado
 - La llave y el tornillo van juntos
 - La llave de tuercas se vende por separado

Partes

División	Piezas de Refacción				
	Básico				Opcional
	Cuña	Tornillo Sujeción	Tornillo Llave	Tornillo Llave	Llave
Tipo					
FMC16	K8.0(A)	-	BX0310	BX0820	LW-6
FMC22	K10.0(C)	-	BX0412	BX1030	LW-8
FMC27	K12.0	MBA-M12	BX0616	-	LW-10
FMC32	K14.0	MBA-M16	BX0820	-	LW-14



BLK

Blank Tool

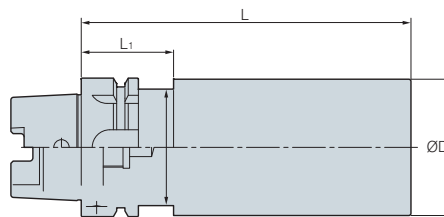

(mm)

Código	Ød	ØC	L	L ₁
HSK40A - BLK42 - 180	42	34	180	35
HSK50A - BLK52 - 200	52	42	200	42
HSK63A -	BLK63 - 150	63	150	42
	BLK63 - 250	63	250	42
	BLK82 - 200	82	200	42
HSK100A -	BLK102 - 150	102	150	45
	BLK102 - 250	102	250	45
	BLK126 - 200	126	200	45
BT30 - BLK48 - 180	48	44	180	30
BT40 -	BLK63 - 150	63	150	35
	BLK63 - 250	63	250	35
	BLK82 - 200	82	200	35
BT50 -	BLK102 - 150	102	150	48
	BLK102 - 250	102	250	48
	BLK126 - 200	126	200	48

HT

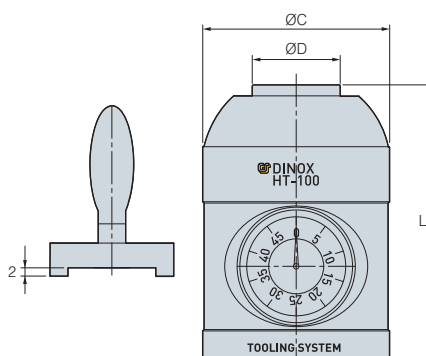

(mm)

Código	ØD	ØC	L
HT-100	32	68	100

- Buena para establecer la longitud de herramientas al CNC
- No se interfiere entre setter altura táctil y la herramienta hace el trabajo seguro
- Precisión Localización: $\pm 0.003\text{mm}$



SC Limpiador de husillo



(mm)

Código	Cónico	N.W.	G.W.
SC - BT30	BT30	0.06kg	0.08kg
BT40	BT40	0.07kg	0.1kg
BT50	BT50	0.16kg	0.2kg
HSK50	HSK50	0.08kg	0.12kg
HSK63	HSK63	0.1kg	0.13kg
HSK100	HSK100	0.5kg	0.7kg

Características

- Las tiras de limpieza del limpiador cónico están hechas de piel de cordero
- Se usa para limpiar el interior del husillo para evitar la electricidad estática y ampliar la vida útil del husillo y el cono

KCP

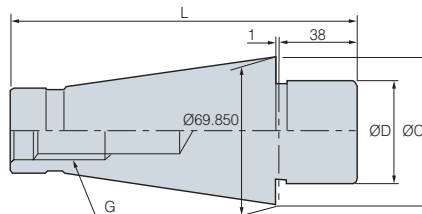

(mm)

Código	Cónico	Diámetro del Cortador	ØD	ØC	L	G
NTN 50 - KCP47.625	NT50	200(8")	47.625	69.55	164.00	U1"-8(M24)
KCP60	NT50	200(8")	60	69.55	164.00	M24



Pernos de Retención

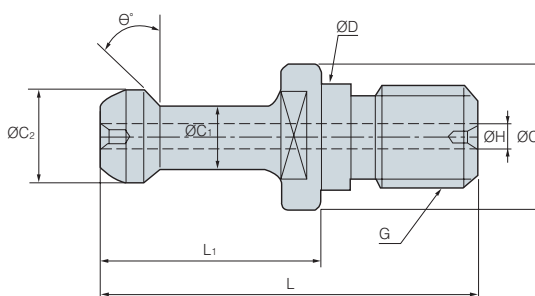

(mm)

Código	ØD	ØC	ØC ₁	ØC ₂	L ₁	L	θ	G	ØH
P20T-1	8.5	12	6	8.5	17.5	31.5	15°	M8	
P30T-1	12.5	16.5	7	11	23	43	45°	M12	
P30T-1(Ø2.5)	12.5	16.5	7	11	23	43	45°	M12	Ø2.5
P30T-2	12.5	16.5	7	11	23	43	30°	M12	
P30T-2(Ø2.5)	12.5	16.5	7	11	23	43	30°	M12	Ø2.5
P40T-1	17	23	10	15	35	60	45°	M16	
P40T-1(3)	17	23	10	15	35	60	45°	M16	Ø3
P40T-2	17	23	10	15	35	60	30°	M16	
PS40-3F	17	23	10	15	35	60	0°	M16	
PS-G51	17	22	12.45	18.8	19.11	44.11	45°	M16	Ø7
DIN69872-A40	17	23	14	19	26	54	15°	M16	Ø7
DIN69872-B40	17	23	14	19	26	54	15°	M16	
JISB6339-A40(PS-806)	17	23	14	19	29	54	15°	M16	Ø7
JISB6339-B40(PS-805)	17	23	14	19	29	54	15°	M16	
P50T-1	25	38	17	23	45	85	45°	M24	
P50T-1(7)	25	38	17	23	45	85	45°	M24	Ø7
P50T-2	25	38	17	23	45	85	30°	M24	
PS50-1F	25	38	17	23	45	85	0°	M24	
PS50-1FH	25	38	17	23	45	85	0°	M24	Ø8
PS-G41	25	37	20.83	28.96	25.2	65.2	45°	M24	Ø10
DIN69872-A50	25	36	21	28	34	74	15°	M24	Ø11.5
P50T-1HS	25	38	17	23	45	85	45°	M24	Ø5.7

