



CORING RODS AND CASING CATALOG

TABLE OF CONTENTS

RODS

05



Q™ Rods	06
RQ™ Rods	10
XQ™ Rods	16
HD Rods	20
W-Wall™	22

TECHNICAL SPECIFICATIONS 31



Coring Rod Depth Rating	32
Coring Rod Torque Rating	33
Coring Rod Pullback Rating	34
ARQ™TK	35
BQ™	36
BRQ™	37
BRQ™TK	38
BXQ™	39
NQ™	40
NRQ™	41
NXQ™	42
NXQ™ W-Wall™	43
HQ™	44
HRQ™	45
HXQ™	46
HXQ™ W-Wall™	47
PHD	48
PHD W-Wall™	49

CASING

26

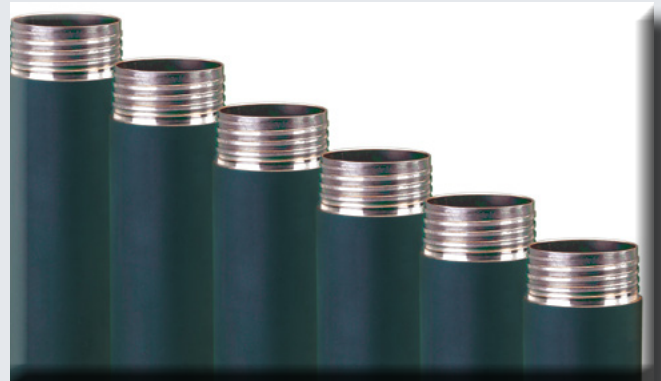

WT Casing	27
-----------	----

CARE AND HANDLING 50



Guidelines for Use, Care & Handling	51
Making & Breaking Drill String	54
Rod Wear	60
Wear Gauges	61
Loads & Deviated Holes	63
Mid-Body Twisting	64

TROUBLESHOOTING

66



Stand-Off Gap & Leakage	67
Fatigue Failure	68
Premature Box End Cracking	69
Thread Wear or Galling	70
Box Wear/Box Bulging/Thread Jumping	71
External Shoulder Wear	72
Mid-Body Wear & Fatigue Failures	72
Rod Twisting	73

ACCESSORIES

74





Glossary	74
Warranty	79

Contact your local Boart Longyear representative by visiting our website at boartLongyear.com/contact-us...

To get Boart Longyear news direct, follow us on LinkedIn, Facebook, and Twitter.

 Boart-Longyear

 @BoartLongyearCareers

 @BoartLongyear

HISTORY

LONGYEAR AND HODGE

Founded in 1903, Longyear and Hodge was started to focus on all activities outside of the Mesabi Iron Range. It soon became clear a shop and warehouse was required to support all the drilling. In 1908 the first manufacturing and repair facility was opened in Marquette Mi, producing rod and casing among other things. By 1911 the company incorporated and bought out Hodge, becoming E J Longyear Co.

CANADIAN LONGYEAR

During the Depression, competition for sales in the Canadian exploration market was fierce and importation duties steep. In 1930, to better serve customers, Longyear opened a small warehouse and manufacturing facility in North Bay. The facility began by producing rod, casing and unique tools for Canada. In the future North Bay would become the center of all coring rod development.

Q™ ROD

In 1946, Longyear's best drilling troubleshooter witnessed use of wireline tooling on a Shell Oil rig, pulling a 1 1/2" core using a 9 1/4" bit. He understood the savings that could be generated if a similar system could be developed for thin-walled coring applications. After starting with AX casing, he quickly realized that an optimized drill rod with a stronger thread would be needed. After years of development, the wireline system including a new drill rod was awarded, US#2,829,868 in 1958. Recognizing the limitations of the square thread custom rod used in the first wireline system, Longyear developed the Q™ rod with a tapered ACME thread. Released in 1966, the Q rod provided a significant productivity increase through easier making and breaking.

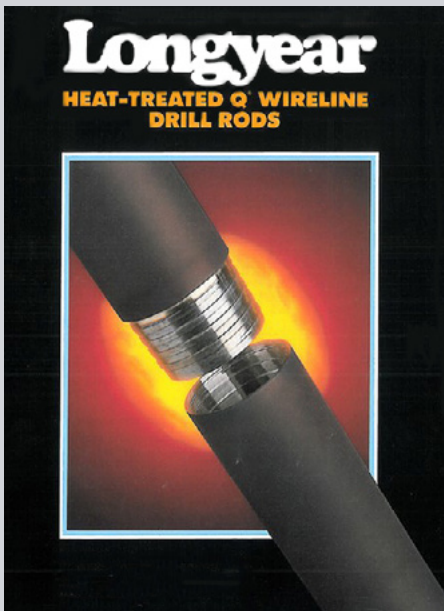

HISTORICAL TIMELINE

1910

1908: Longyear and Hodge start manufacturing in Marquette Mi, including rod and casing

1930

1930: Canadian Longyear starts producing rod and casing in North Bay

1950

1946: LTK conventional corebarrel

1958: Boart introduces first Q™ wireline system

1970

1965: DCDMA standardizes W (World) drill rod with coarser 3 TPI threads and larger OD

1966: Q™ drill rod launched with tapered ACME thread

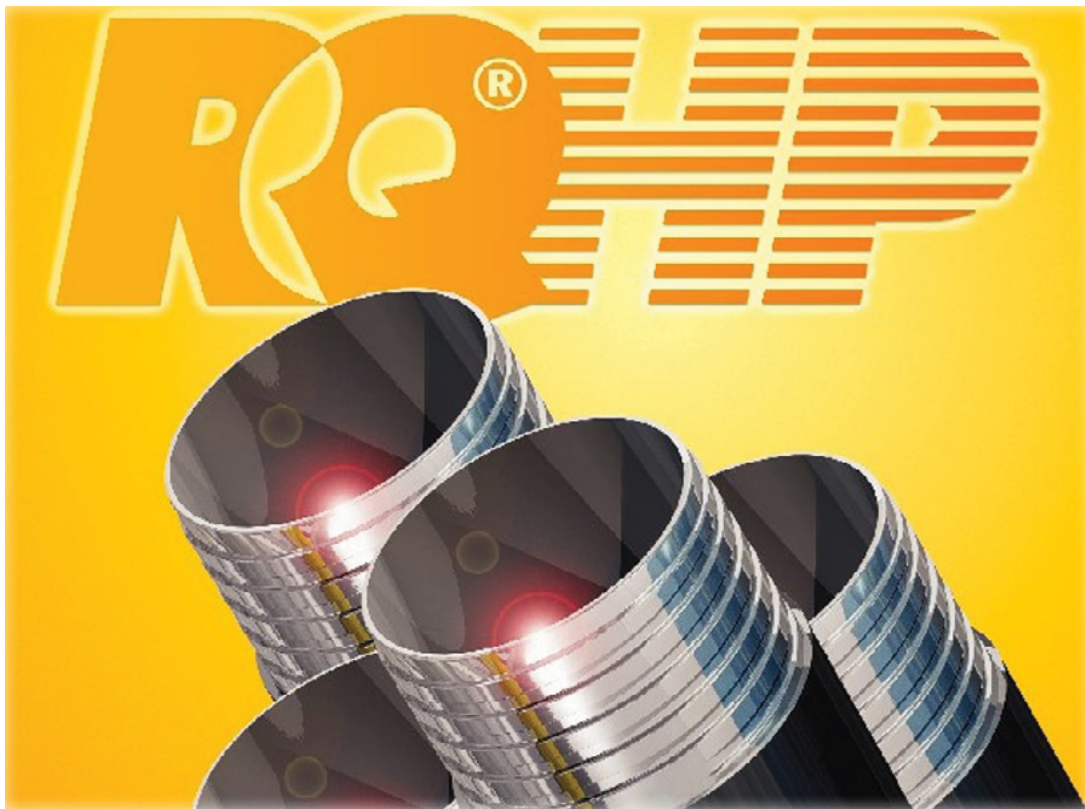

RQ™ REVOLUTION

In 1995, Longyear engineers were conducting load testing on rod. During this exercise, they observed that reverse flank angles on threads would imitate the load response of rod mid-bodies, which would mean much higher load capacities. At the same time, manufacturing was developing heat treat processes to improve the material strength in the joints. Boart Longyear combined both innovations and launched a new patented rod, RQ™ in 1999. RQ achieved 2x the strength and wear life over Q™ rod based on these new features, and reached many regional depth records for coring.

CONTINUED INNOVATION

In 2018 Longyear launched XQ™ rods, featuring two significant improvements over RQ™. The first is adding a second thread to more uniformly distributed loads, and the second is removal of the initial partial threads. The result is a rod with 33% more depth capacity, 2x the thread life and automatic starting, easing joint make-up for automation and manual threading alike.

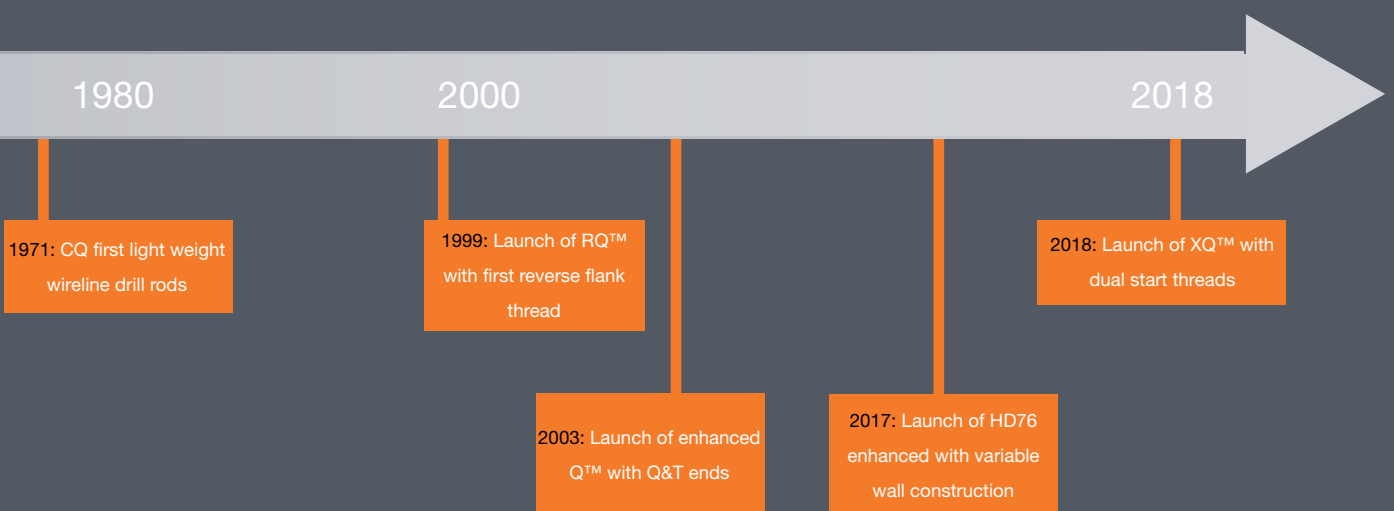

WIRELINE CORING RODS

Q™ Rods	06
RQ™	10
XQ™	16
HD Rods	18
W-Wall™	20

Q™ rods were first introduced in 1966 and the proprietary design continues to be the worldwide choice for wireline coring rods. The Q rods are known as an industry breakthrough, delivering a coarse tapered thread for easy make and break. Soon after, the introduction of pin thread case hardening greatly extended thread life.



TUBING

- High quality alloy steel tubing.
- 100% inspection ensures consistent concentricity, straightness and heat treatment.

THREAD

- Tapered, coarse threads (3 threads per inch) provides easy make and break.
- Load efficiency of 30% provides sufficient strength for average applications.

THRU-WALL HEAT TREATMENT

- Provides 140% material strength.
- Heat treated box threads significantly increase thread life.
- Q™ is a Boart Longyear™ proprietary product and as such contains all of the quality, features and fit associated with Boart Longyear manufacturing standards.

CASE HARDENING

- Boart Longyear is the only major manufacturer in the industry to case-harden threads.
- Pin thread crest is hardened to nominal 55 HRC to eliminate damaging 'adhesion' wear.
- Eliminates the transfer of wear material back and forth as seen between threads of equal hardness, leading to large scale galling and joint seizing.
- Many years of process development and proven field performance, globally, has resulted in unmatched thread wear life and rod joint reliability.

Q™ ROD PART NUMBERS

BQ™

	PART #	DESCRIPTION
METRIC	3548208	ROD, BQ 3.0 m ENHANCED
	3548206	ROD, BQ 1.5 m ENHANCED

OD (mm)	ID (mm)	WEIGHT (kg/3m)	THREAD PITCH	PIN LENGTH (mm)	CONTENT (L/100m)
55.6	46.1	18.8	8.5	44.5	167.0

	PART #	DESCRIPTION
IMPERIAL	3548209	ROD, BQ 10 ft ENHANCED
	3548207	ROD, BQ 5 ft ENHANCED
	51555	ROD, BQ 2 ft*
	51554	ROD, BQ 1 ft*

OD (in)	ID (in)	WEIGHT (lb/10ft)	THREAD PITCH (TPI)	PIN LENGTH (in)	CONTENT (USgal/100ft)
2.19	1.81	42.00	3.00	1.75	13.20



* Do not use rods shorter than 1.5 m at top of hole, as a drive sub or Kelly rod because they do not have Q&T heat treatment; they only have pin thread case hardening for wear. Subs, which are made from Q&T material, should be used for these applications.

BQ™ BUNDLE SPECIFICATIONS

3.0 m/10 ft ROD BUNDLE (19 RODS)

Dimensions (L x W x H).....3,150 x 292 x 254 mm (124 x 11.5 x 10 in)

Volume.....0.23 m³ (8 ft³)

Gross Weight.....355 kg (780 lb)

1.5 m/5 ft ROD BUNDLE (19 RODS)

Dimensions (L x W x H).....1,600 x 292 x 254 mm (63 x 11.5 x 10 in)

Volume.....0.11 m³ (4 ft³)

Gross Weight.....180 kg (400 lb)

CONTAINER SHIPMENTS:

20 ft container load of 3.0 m/10 ft rods holds 42 bundles (798 rods)

40 ft container load of 3.0 m/10 ft rods holds 56 bundles (1,064 rods)

Q™ ROD PART NUMBERS

NQ™

	PART #	DESCRIPTION
METRIC	3548208	ROD, NQ 3.0 m ENHANCED
	3548210	ROD, NQ 1.5 m ENHANCED

OD (mm)	ID (mm)	WEIGHT (kg/3m)	THREAD PITCH	PIN LENGTH (mm)	CONTENT (L/100m)
69.9	60.3	23.4	8.5	44.4	286.0

	PART #	DESCRIPTION
IMPERIAL	3548213	ROD, NQ 10 ft ENHANCED
	3548211	ROD, NQ 5 ft ENHANCED
	51563	ROD, NQ 2 ft*
	51562	ROD, NQ 1 ft*

OD (in)	ID (in)	WEIGHT (lb/10ft)	THREAD PITCH (TPI)	PIN LENGTH (in)	CONTENT (USgal/100ft)
2.75	2.38	52.40	3.00	1.75	23.00



* Do not use rods shorter than 1.5 m at top of hole, as a drive sub or Kelly rod because they do not have Q&T heat treatment; they only have pin thread case hardening for wear. Subs, which are made from Q&T material, should be used for these applications.

NQ™ BUNDLE SPECIFICATIONS

3.0 m/10 ft ROD BUNDLE (19 RODS)

Dimensions (L x W x H).....3,124 x 368 x 300 mm (123 x 14.5 x 13 in)

Volume.....0.37 m³ (13 ft³)

Gross Weight.....453 kg (1,000 lb)

1.5 m/5 ft ROD BUNDLE (19 RODS)

Dimensions (L x W x H).....1,600 x 368 x 330 mm (63 x 14.5 x 13 in)

Volume.....0.20 m³ (7 ft³)

Gross Weight.....239 kg (526 lb)

CONTAINER SHIPMENTS:

20 ft container load of 3.0 m/10 ft rods holds 30 bundles (570 rods)

40 ft container load of 3.0 m/10 ft rods holds 45 bundles (855 rods)

Q™ ROD PART NUMBERS

HQ™

RODS

	PART #	DESCRIPTION
METRIC	3548216	ROD, HQ 3.0 m ENHANCED
	3548214	ROD, HQ 1.5 m ENHANCED

OD (mm)	ID (mm)	WEIGHT (kg/3m)	THREAD PITCH	PIN LENGTH (mm)	CONTENT (L/100m)
88.9	77.8	34.5	8.5	44.4	475.0

	PART #	DESCRIPTION
IMPERIAL	3548217	ROD, HQ 10 ft ENHANCED
	3548215	ROD, HQ 5 ft ENHANCED
	51569	ROD, HQ 2 ft*
	51568	ROD, HQ 1 ft*

OD (in)	ID (in)	WEIGHT (lb/10ft)	THREAD PITCH (TPI)	PIN LENGTH (in)	CONTENT (USgal/100ft)
3.50	3.06	77.00	3.00	1.75	38.20



* Do not use rods shorter than 1.5 m at top of hole, as a drive sub or Kelly rod because they do not have Q&T heat treatment; they only have pin thread case hardening for wear. Subs, which are made from Q&T material, should be used for these applications.

HQ™ BUNDLE SPECIFICATIONS

3.0 m/10 ft ROD BUNDLE (19 RODS)

Dimensions (L x W x H).....3,048 x 470 x 406.4 mm (120 x 18.5 x 16 in)
 Volume.....0.60 m³ (21 ft³)
 Gross Weight.....682 kg (1,505 lb)

1.5 m/5 ft ROD BUNDLE (19 RODS)

Dimensions (L x W x H).....1,588 x 470 x 406.4 mm (62.5 x 18.5 x 16 in)
 Volume.....0.31 m³ (11 ft³)
 Gross Weight.....346 kg (764 lb)

CONTAINER SHIPMENTS:

20 ft container load of 3.0 m/10 ft rods holds 20 bundles (380 rods)
 40 ft container load of 3.0 m/10 ft rods holds 30 bundles (570 rods)

Invented by Boart Longyear in 1996 and launched in 1999, RQ™ rods introduced engineered interlocking joints to the industry, and quickly became renowned for strength and reliability. RQ drill rods expand your drilling capabilities and lower your total drill rod cost per meter/foot in deep, deviated and demanding wireline coring applications.



TUBING

- High quality alloy steel tubing.
- 100% inspection ensures consistent concentricity, straightness and heat treatment.

THREAD

- Coarse RQ™ threads (3 threads per inch) with increased taper and a 10 degree reverse angle load flank provides an interlocking joint with increased strength and anti-jamming for easier make-up.
- Finer RQ™TK threads provide high performance for Thin Kerf wireline systems.
- Load efficiency of 50% provides high strength for demanding applications.
- RQ™ is a Boart Longyear™ proprietary product and as such contains all of the quality, features and fit associated with Boart Longyear manufacturing standards.

THRU-WALL HEAT TREATMENT

- Provides 175% material strength.
- Heat treated box threads significantly increase thread life.

CASE HARDENING

- Boart Longyear is the only major manufacturer in the industry to case-harden threads.
- Pin thread crest is hardened to nominal 55 HRC to eliminate damaging 'adhesion' wear.
- Eliminates the transfer of wear material back and forth as seen between threads of equal hardness, leading to large scale galling and joint seizing.
- Many years of process development and proven field performance, globally, has resulted in unmatched thread wear life and rod joint reliability.

RQ™ ROD PART NUMBERS

The RQ™TK rods utilize a reduced wall thickness to allow for the larger size tools and core samples obtained with the corresponding Q™TK wireline system. RQ™TK rods are not compatible with our standard RQ™ coring rods.

ARQ™TK

	PART #	DESCRIPTION
METRIC	3540968	ARQTK 3.0 m ROD
	104977	ARQTK 1.5 m ROD

OD (mm)	ID (mm)	WEIGHT (kg/3m)	THREAD PITCH	PIN LENGTH (mm)	CONTENT (L/100m)
44.7	37.5	10.7	6.4	38.5	110.0

	PART #	DESCRIPTION
IMPERIAL	3540970	ARQTK 10 ft ROD
	3540971	ARQTK 5 ft ROD
	3540972	ARQTK 2 ft ROD
	3541568	ARQTK 1 ft ROD

OD (in)	ID (in)	WEIGHT (lb/10ft)	THREAD PITCH (TPI)	PIN LENGTH (in)	CONTENT (USgal/100ft)
1.76	1.47	24.00	4.00	1.52	8.90



* Do not use rods shorter than 1.5 m at top of hole, as a drive sub or Kelly rod because they do not have Q&T heat treatment; they only have pin thread case hardening for wear. Subs, which are made from Q&T material, should be used for these applications.

ARQ™TK BUNDLE SPECIFICATIONS

3.0 m/10 ft ROD BUNDLE (19 RODS)

Dimensions (L x W x H).....3.2 x 0.2 x 0.2 m (10.3 x 0.8 x 0.7 ft)
 Volume.....0.2 m³ (7 ft³)
 Gross Weight.....213 kg (470 lb)

1.5 m/5 ft ROD BUNDLE (19 RODS)

Dimensions (L x W x H).....1.6 x 0.2 x 0.2 m (5.3 x 0.8 x 0.7 ft)
 Volume.....0.1 m³ (3.5 ft³)
 Gross Weight.....111 kg (246 lb)

CONTAINER SHIPMENTS:

20 ft container load of 3.0 m/10 ft rods holds 63 bundles (1,197 rods)
 40 ft container load of 3.0 m/10 ft rods holds 90 bundles (1,710 rods)

RQ™ ROD PART NUMBERS

BRQ™TK

	PART #	DESCRIPTION
METRIC	306227	BRQTK 3.0 m ROD
	3540867	BRQTK 1.5 m ROD

OD (mm)	ID (mm)	WEIGHT (kg/3m)	THREAD PITCH	PIN LENGTH (mm)	CONTENT (L/100m)
55.8	48.4	14.3	7.3	40.6	184.0

	PART #	DESCRIPTION
IMPERIAL	3541174	BRQTK 10 ft ROD
	3541379	BRQTK 5 ft ROD
	3541343	BRQTK 2 ft ROD
	3545303	BRQTK 1 ft ROD

OD (in)	ID (in)	WEIGHT (lb/10ft)	THREAD PITCH (TPI)	PIN LENGTH (in)	CONTENT (USgal/100ft)
2.20	1.91	32.00	3.50	1.60	14.80



* Do not use rods shorter than 1.5 m at top of hole, as a drive sub or Kelly rod because they do not have Q&T heat treatment; they only have pin thread case hardening for wear. Subs, which are made from Q&T material, should be used for these applications.

BRQ™TK BUNDLE SPECIFICATIONS

3.0 m/10 ft ROD BUNDLE (19 RODS)

Dimensions (L x W x H).....3.2 x 0.3 x 0.3 m (10.3 x 1.0 x 0.8 ft)

Volume.....0.2 m³ (8.1 ft³)

Gross Weight.....306 kg (675 lb)

1.5 m/5 ft ROD BUNDLE (19 RODS)

Dimensions (L x W x H).....1.6 x 0.3 x 0.3 m (5.3 x 1.0 x 0.8 ft)

Volume.....0.1 m³ (3.5 ft³)

Gross Weight.....160 kg (350 lb)

CONTAINER SHIPMENTS:

20 ft container load of 3.0 m/10 ft rods holds 42 bundles (798 rods)

40 ft container load of 3.0 m/10 ft rods holds 68 bundles (1,292 rods)

RQ™ ROD PART NUMBERS

BRQ™

	PART #	DESCRIPTION
METRIC	306238	BRQ 3.0 m ROD
	3541308	BRQ 1.5 m ROD

OD (mm)	ID (mm)	WEIGHT (kg/3m)	THREAD PITCH	PIN LENGTH (mm)	CONTENT (L/100m)
55.6	46.2	18.8	8.5	41.9	167.0

	PART #	DESCRIPTION
IMPERIAL	3541555	BRQ 10 ft ROD
	3541378	BRQ 5 ft ROD
	3541340	BRQ 2 ft ROD
	3545301	BRQ 1 ft ROD

OD (in)	ID (in)	WEIGHT (lb/10ft)	THREAD PITCH (TPI)	PIN LENGTH (in)	CONTENT (USgal/100ft)
2.19	1.81	42.00	3.00	1.65	13.20



* Do not use rods shorter than 1.5 m at top of hole, as a drive sub or Kelly rod because they do not have Q&T heat treatment; they only have pin thread case hardening for wear. Subs, which are made from Q&T material, should be used for these applications.

BRQ™ BUNDLE SPECIFICATIONS

3.0 m/10 ft ROD BUNDLE (19 RODS)

Dimensions (L x W x H).....3.2 x 0.3 x 0.3 m (10.3 x 1.0 x 0.8 ft)
 Volume.....0.2 m³ (8.1 ft³)
 Gross Weight.....355 kg (780 lb)

1.5 m/5 ft ROD BUNDLE (19 RODS)

Dimensions (L x W x H).....1.6 x 0.3 x 0.3 m (5.3 x 1.0 x 0.8 ft)
 Volume.....0.1 m³ (3.5 ft³)
 Gross Weight.....180 kg (400 lb)

CONTAINER SHIPMENTS:

20 ft container load of 3.0 m/10 ft rods holds 42 bundles (798 rods)
 40 ft container load of 3.0 m/10 ft rods holds 56 bundles (1,064 rods)

RQ™ ROD PART NUMBERS

NRQ™

	PART #	DESCRIPTION
METRIC	104741	NRQ 3.0 m ROD
	3514309	NRQ 1.5 m ROD

OD (mm)	ID (mm)	WEIGHT (kg/3m)	THREAD PITCH	PIN LENGTH (mm)	CONTENT (L/100m)
69.9	60.3	23.4	8.5	41.9	286.0

	PART #	DESCRIPTION
IMPERIAL	3541556	NRQ 10 ft ROD
	3541380	NRQ 5 ft ROD
	3541341	NRQ 2 ft ROD
	3542459	NRQ 1 ft ROD

OD (in)	ID (in)	WEIGHT (lb/10ft)	THREAD PITCH (TPI)	PIN LENGTH (in)	CONTENT (USgal/100ft)
2.75	2.38	52.40	3.00	1.65	23.00



WARNING

* Do not use rods shorter than 1.5 m at top of hole, as a drive sub or Kelly rod because they do not have Q&T heat treatment; they only have pin thread case hardening for wear. Subs, which are made from Q&T material, should be used for these applications.

NRQ™ BUNDLE SPECIFICATIONS

3.0 m/10 ft ROD BUNDLE (19 RODS)

Dimensions (L x W x H).....3.2 x 0.4 x 0.3 m (10.3 x 1.2 x 1.1 ft)

Volume.....0.4 m³ (13 ft³)

Gross Weight.....453 kg (1,000 lb)

1.5 m/5 ft ROD BUNDLE (19 RODS)

Dimensions (L x W x H).....1.6 x 0.4 x 0.3 m (5.3 x 1.2 x 1.1 ft)

Volume.....0.2 m³ (7 ft³)

Gross Weight.....239 kg (526 lb)

CONTAINER SHIPMENTS:

20 ft container load of 3.0 m/10 ft rods holds 30 bundles (570 rods)

40 ft container load of 3.0 m/10 ft rods holds 45 bundles (855 rods)

RQ™ ROD PART NUMBERS

HRQ™

	PART #	DESCRIPTION
METRIC	306243	HRQ 3.0 m ROD
	3541310	HRQ 1.5 m ROD

OD (mm)	ID (mm)	WEIGHT (kg/3m)	THREAD PITCH	PIN LENGTH (mm)	CONTENT (L/100m)
88.9	77.8	34.5	8.5	41.9	475.0

	PART #	DESCRIPTION
IMPERIAL	3541558	HRQ 10 ft ROD
	3541381	HRQ 5 ft ROD
	3541342	HRQ 2 ft ROD
	3545071	HRQ 1 ft ROD

OD (in)	ID (in)	WEIGHT (lb/10ft)	THREAD PITCH (TPI)	PIN LENGTH (in)	CONTENT (USgal/100ft)
3.50	3.06	77.00	3.00	1.65	38.20



* Do not use rods shorter than 1.5 m at top of hole, as a drive sub or Kelly rod because they do not have Q&T heat treatment; they only have pin thread case hardening for wear. Subs, which are made from Q&T material, should be used for these applications.

HRQ™ BUNDLE SPECIFICATIONS

3.0 m/10 ft ROD BUNDLE (19 RODS)

Dimensions (L x W x H).....3.2 x 0.5 x 0.4 m (10.3 x 1.5 x 1.3 ft)
 Volume.....0.6 m³ (21.2 ft³)
 Gross Weight.....682 kg (1,505 lb)

1.5 m/5 ft ROD BUNDLE (19 RODS)

Dimensions (L x W x H).....1.6 x 0.5 x 0.4 m (5.3 x 1.5 x 1.3 ft)
 Volume.....0.3 m³ (10.9 ft³)
 Gross Weight.....346 kg (764 lb)

CONTAINER SHIPMENTS:

20 ft container load of 3.0 m/10 ft rods holds 20 bundles (380 rods)
 40 ft container load of 3.0 m/10 ft rods holds 30 bundles (570 rods)

XQ™ ROD

Patented XQ™ wireline coring rods feature a combination of exclusive heat treatments and innovative engineering to provide the ultimate in performance and longevity. XQ drill rods are stronger, last longer, and offer easier make and break. Featuring innovative self-aligning, double-start threads, rod joints engage smoothly without wedging or jamming. XQ threads significantly improve depth capacity, productivity, and life.

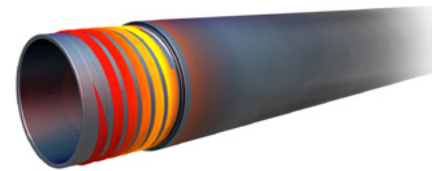
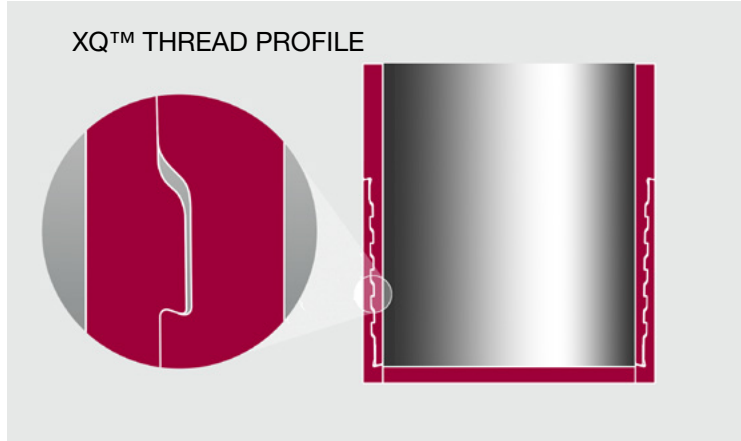

TUBING

- High quality alloy steel tubing.
- 100% inspection ensures consistent concentricity, straightness and heat treatment.

THREAD

- Patented double-start, tapered, coarse threads (2 threads per inch) with 20 degree reversed angle load flanks, balance load stresses across the joint, providing the ultimate in strength and life.
- Patented self aligning thread start geometry eliminates wedging and jamming for smooth make-up and maximum productivity.
- Load efficiency of up to 60% provides the ultimate in strength for demanding applications, and maximum reliability and productivity in all applications.

THRU-WALL HEAT TREATMENT

- Provides 175% material strength.
- Heat treated box threads significantly increase thread life.
- XQ™ is a Boart Longyear™ proprietary product and as such contains all of the quality, features and fit associated with Boart Longyear manufacturing standards.

CASE HARDENING

- Boart Longyear is the only major manufacturer in the industry to case-harden threads.
- Pin thread crest is hardened to nominal 55 HRC to eliminate damaging 'adhesion' wear.
- Eliminates the transfer of wear material back and forth as seen between threads of equal hardness, leading to large scale galling and joint seizing.
- Many years of process development and proven field performance, globally, has resulted in unmatched thread wear life and rod joint reliability.

Patents AU2012209354; AU2013315186; CA2884798; CA2825533; CN201280010513; RU2607560; US9810029; US9850723; ZA2013/06418; Patents Pending.

XQ™ ROD PART NUMBERS

BXQ™

	PART #	DESCRIPTION
METRIC	5008505	BXQ 3.0 m ROD
	5009229	BXQ 1.5 m ROD

OD (mm)	ID (mm)	WEIGHT (kg/3m)	THREAD PITCH	PIN LENGTH (mm)	CONTENT (L/100m)
55.6	46.2	18.8	12.7	44.5	167.0

	PART #	DESCRIPTION
IMPERIAL	5008504	BXQ 10 ft ROD
	5009228	BXQ 5 ft ROD
	5009144	BXQ 2 ft ROD
	5009143	BXQ 1 ft ROD

OD (in)	ID (in)	WEIGHT (lb/10ft)	THREAD PITCH (TPI)	PIN LENGTH (in)	CONTENT (USgal/100ft)
2.19	1.81	42.00	2.00	1.75	13.20



* Do not use rods shorter than 1.5 m at top of hole, as a drive sub or Kelly rod because they do not have Q&T heat treatment; they only have pin thread case hardening for wear. Subs, which are made from Q&T material, should be used for these applications.

BXQ™ BUNDLE SPECIFICATIONS

3.0 m/10 ft ROD BUNDLE (19 RODS)

Dimensions (L x W x H).....3.2 x 0.3 x 0.3 m (10.3 x 1.0 x 0.8 ft)
 Volume.....0.2 m³ (8.1 ft³)
 Gross Weight.....355 kg (780 lb)

1.5 m/5 ft ROD BUNDLE (19 RODS)

Dimensions (L x W x H).....1.6 x 0.3 x 0.3 m (5.3 x 1.0 x 0.8 ft)
 Volume.....0.1 m³ (3.5 ft³)
 Gross Weight.....180 kg (400 lb)

CONTAINER SHIPMENTS:

20 ft container load of 3.0 m/10 ft rods holds 30 bundles (798 rods)
 40 ft container load of 3.0 m/10 ft rods holds 56 bundles (1,064 rods)

NXQ™ ROD PART NUMBERS

NXQ™

	PART #	DESCRIPTION
METRIC	5008502	NXQ 3.0 m ROD
	5009231	NXQ 1.5 m ROD

OD (mm)	ID (mm)	WEIGHT (kg/3m)	THREAD PITCH	PIN LENGTH (mm)	CONTENT (L/100m)
69.9	60.3	23.4	12.7	44.5	286.0

	PART #	DESCRIPTION
IMPERIAL	5008501	NXQ 10 ft ROD
	5009230	NXQ 5 ft ROD
	5008944	NXQ 2 ft ROD
	5009142	NXQ 1 ft ROD

OD (in)	ID (in)	WEIGHT (lb/10ft)	THREAD PITCH (TPI)	PIN LENGTH (in)	CONTENT (USgal/100ft)
2.75	2.38	52.40	2.00	1.75	23.00



* Do not use rods shorter than 1.5 m at top of hole, as a drive sub or Kelly rod because they do not have Q&T heat treatment; they only have pin thread case hardening for wear. Subs, which are made from Q&T material, should be used for these applications.

NXQ™ BUNDLE SPECIFICATIONS

3.0 m/10 ft ROD BUNDLE (19 RODS)

Dimensions (L x W x H).....3.2 x 0.4 x 0.3 m (10.3 x 1.2 x 1.1 ft)

Volume.....0.4 m³ (13 ft³)

Gross Weight.....453 kg (1,000 lb)

1.5 m/5 ft ROD BUNDLE (19 RODS)

Dimensions (L x W x H).....1.6 x 0.4 x 0.3 m (5.3 x 1.2 x 1.1 ft)

Volume.....0.2 m³ (7 ft³)

Gross Weight.....239 kg (526 lb)

CONTAINER SHIPMENTS:

20 ft container load of 3.0 m/10 ft rods holds 30 bundles (570 rods)

40 ft container load of 3.0 m/10 ft rods holds 45 bundles (855 rods)

XQ™ ROD PART NUMBERS

HXQ™

	PART #	DESCRIPTION
METRIC	5008508	HXQ 3.0 m ROD
	5009233	HXQ 1.5 m ROD

OD (mm)	ID (mm)	WEIGHT (kg/3m)	THREAD PITCH	PIN LENGTH (mm)	CONTENT (L/100m)
88.9	77.8	34.5	12.7	44.5	475.0

	PART #	DESCRIPTION
IMPERIAL	5008507	HXQ 10 ft ROD
	5009232	HXQ 5 ft ROD
	5009146	HXQ 2 ft ROD
	5009145	HXQ 1 ft ROD

OD (in)	ID (in)	WEIGHT (lb/10ft)	THREAD PITCH (TPI)	PIN LENGTH (in)	CONTENT (USgal/100ft)
3.50	3.06	77.00	2.00	1.75	38.20



* Do not use rods shorter than 1.5 m at top of hole, as a drive sub or Kelly rod because they do not have Q&T heat treatment; they only have pin thread case hardening for wear. Subs, which are made from Q&T material, should be used for these applications.

HXQ™ BUNDLE SPECIFICATIONS

3.0 m/10 ft ROD BUNDLE (19 RODS)

Dimensions (L x W x H).....3.2 x 0.5 x 0.4 m (10.3 x 1.5 x 1.3 ft)
 Volume.....0.6 m³ (21.2 ft³)
 Gross Weight.....682 kg (1,505 lb)

1.5 m/5 ft ROD BUNDLE (19 RODS)

Dimensions (L x W x H).....1.6 x 0.5 x 0.4 m (5.3 x 1.5 x 1.3 ft)
 Volume.....0.3 m³ (10.9 ft³)
 Gross Weight.....346 kg (764 lb)

CONTAINER SHIPMENTS:

20 ft container load of 3.0 m/10 ft rods holds 20 bundles (380 rods)
 40 ft container load of 3.0 m/10 ft rods holds 30 bundles (570 rods)

HD ROD

HD Rods are designed for reliability in large size core drilling, featuring a robust, coarse thread profile for heavy duty wireline applications.



TUBING

- High quality alloy steel tubing.
- 100% inspection ensures consistent concentricity, straightness and heat treatment.

THREAD

- Larger, deeper threads (2.5 threads per inch) provide maximum durability.
- Load efficiency of 40% provides sufficient strength for large hole sizes.
- HD is a Boart Longyear™ proprietary product and as such contains all of the quality, features and fit associated with Boart Longyear manufacturing standards.

CASE HARDENING

- Boart Longyear is the only major manufacturer in the industry to case-harden threads.
- Pin thread crest is hardened to eliminate damaging 'adhesion' wear.
- Eliminates the transfer of wear material back and forth as seen between threads of equal hardness, leading to large scale galling and joint seizing.
- Many years of process development and proven field performance, globally, has resulted in unmatched thread wear life and rod joint reliability.

HD ROD PART NUMBERS

PHD

	PART #	DESCRIPTION
METRIC	3542314	PHD 3.0 m ROD
	3541743	PHD 1.5 m ROD

OD (mm)	ID (mm)	WEIGHT (kg/3m)	THREAD PITCH	PIN LENGTH (mm)	CONTENT (L/100m)
114.3	101.6	52.2	10.2	62.7	811.0

	PART #	DESCRIPTION
IMPERIAL	3540845	PHD 10 ft ROD
	3540844	PHD 5 ft ROD
	3542519	PHD 2 ft ROD
	N/A	PHD 1 ft ROD

OD (in)	ID (in)	WEIGHT (lb/10ft)	THREAD PITCH (TPI)	PIN LENGTH (in)	CONTENT (USgal/100ft)
4.50	4.00	117.00	2.50	2.47	65.30



* Do not use rods shorter than 1.5 m at top of hole, as a drive sub or Kelly rod because they do not have Q&T heat treatment; they only have pin thread case hardening for wear. Subs, which are made from Q&T material, should be used for these applications.

PHD BUNDLE SPECIFICATIONS

3.0 m/10 ft ROD BUNDLE (19 RODS)

Dimensions (L x W x H).....3.2 x 0.4 x 0.3 m (10.3 x 1.2 x 1.1 ft)
 Volume.....0.4 m³ (14.1 ft³)
 Gross Weight.....373 kg (823 lb)

1.5 m/5 ft ROD BUNDLE (19 RODS)

Dimensions (L x W x H).....1.6 x 0.4 x 0.3 m (5.3 x 1.2 x 1.1 ft)
 Volume.....0.2 m³ (7.1 ft³)
 Gross Weight.....194 kg (428 lb)

CONTAINER SHIPMENTS:

20 ft container load of 3.0 m/10 ft rods holds 30 bundles (210 rods)
 40 ft container load of 3.0 m/10 ft rods holds 54 bundles (378 rods)

W-WALL™

W-Wall™ is a unique patented internal-upset rod tubing, available with RQ™ as well as XQ™ and HD, available with RQ, XQ or HD threads. W-Wall tubing undergoes the same unique processing and heat treatment as our standard wall tubing, for performance in demanding applications.

W-WALL FOR INCREASED PRODUCTIVITY & REDUCED COSTS

With up to 30% less weight in the drill string, productivity will increase while overall operation costs will be reduced.

W-WALL RODS

- Decrease operator fatigue in rod handling — increasing safety and productivity.
- Decrease fuel costs in rod transportation, and increase the fuel efficiency of each rig on the site.
- Increase drill's rated depth capacity. For example, a LF™90D PHD Straight Wall can drill 417 m, while the PDH W-Wall can drill 542 m, increasing by 30%.
- Increase mid-body flexibility, which is advantageous in wedging or steering applications, but does not reduce drill string stiffness during coring operations.

W-WALL™ FOR FASTER INNER TUBE TRIPPING

Annular clearance between the core barrel and the interior wall of the rod is larger which enables faster core barrel tripping speeds.

When combined with Quick Descent™ core barrel technology, tripping speed increases up to 50%.

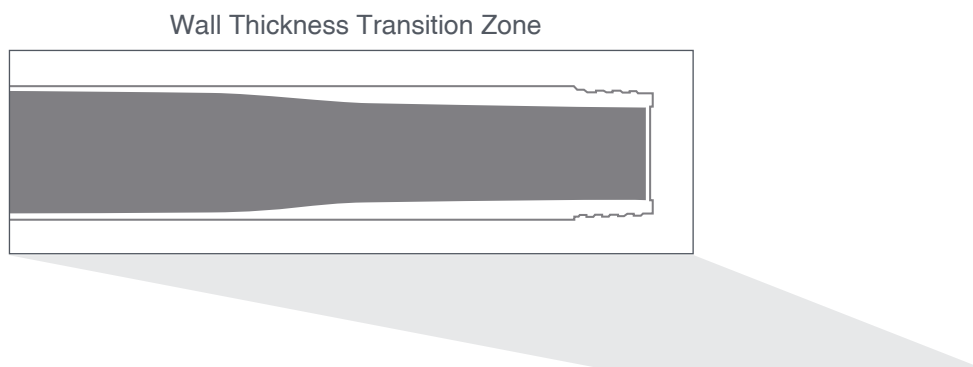

Usable under the following patents: AU200822974; CA2679933; CN101675205; US8333255; US9359847; US9932775; ZA2009/05921; Patents Pending.

Patents CN ZL 2015800389366; RU 2651650; US 9,932,775; US 10,024,117; Patents pending

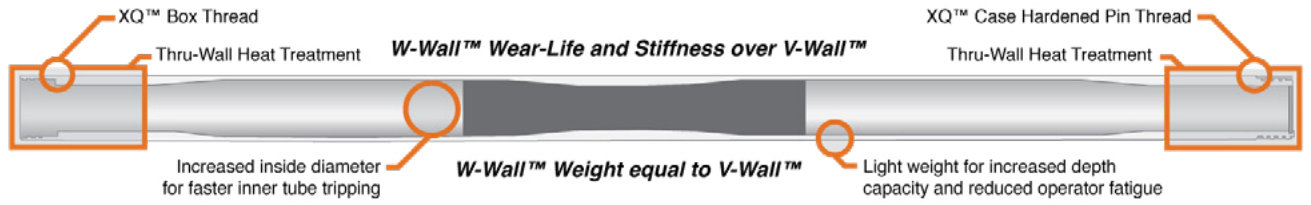

PHD W-WALL VS. STRAIGHT WALL

Drill: BLY LF™90D
Pullback Rating:
16,000 lbs (7273 KG)



0 m

250 m

500 m

PHD W-WALL
542 M

+30%

PHD STRAIGHT
417 M

HXQ W-WALL VS. STRAIGHT WALL

Drill: BLY LF™90D
Pullback Rating:
16,000 lbs (7273 KG)



750 m

1,000 m

1250 m

HXQ W-WALL
773 M

+22%

HQ STRAIGHT
634 M

NXQW-WALL VS. STRAIGHT WALL

Drill: BLY LF™90D
Pullback Rating:
16,000 lbs (7273 KG)



HXQ W-WALL
1061 M

+14%

NQ STRAIGHT
931 M

	PART #	DESCRIPTION
METRIC	5008807	NXQ 3.0 m W-Wall Rod
	5008811	HXQ 3.0 m W-Wall Rod

OD (mm)	BODY ID (mm)	JOINT ID (mm)	WEIGHT (km/3m)	THREAD PITCH	PIN LENGTH (mm)	CONTENT (L/100m)
69.9	62.0	60.3	20.7	12.7	41.9	297.0
88.9	81.0	77.8	27.3	12.7	41.9	506.0

	PART #	DESCRIPTION
IMPERIAL	5008806	NXQ 10 ft W-Wall Rod
	5008810	HXQ 10 ft W-Wall Rod

OD (in)	BODY ID (in)	JOINT ID (in)	WEIGHT (lb/10ft)	THREAD PITCH (TPI)	PIN LENGTH (in)	CONTENT (USgal/100ft)
2.75	2.44	2.38	45.00	2.00	1.60	23.90
3.50	3.19	3.06	60.00	2.00	1.60	40.70



* Do not use rods shorter than 1.5 m at top of hole, as a drive sub or Kelly rod because they do not have Q&T heat treatment; they only have pin thread case hardening for wear. Subs, which are made from Q&T material, should be used for these applications.

W-WALL™ ROD BUNDLE SPECIFICATIONS

NQ/NRQ 3.0 m/10 ft ROD BUNDLE (19 RODS)

Dimensions (L x W x H).....	3.2 x 0.40 x 0.30 m (10.3 x 1.2 x 1.1 ft)
Volume.....	0.40 m ³ (13.0 ft ³)
Gross Weight.....	394 kg (869 lb)

1.5 m/5 ft ROD BUNDLE (7 RODS)

Dimensions (L x W x H).....	3.2 x 0.50 x 0.40 m (10.3 x 1.5 x 1.3 ft)
Volume.....	0.60 m ³ (21.2 ft ³)
Gross Weight.....	540 kg (1,191 lb)

CONTAINER SHIPMENTS:

- 20 ft container load of 3.0 m/10 ft rods holds 30 bundles (570 rods)
- 40 ft container load of 3.0 m/10 ft rods holds 50 bundles (950 rods)

HD™ ROD PART NUMBERS

The W-Wall™ is an internally-upset rod available with our high load-efficiency patented XQ™ thread or HD thread. In addition, all W-Wall rods undergo our unique combinations of heat treatment processes for performance in demanding applications.

	PART #	DESCRIPTION
METRIC	5008537	Rod, PHD 3.0 M W-Wall

OD (mm)	BODY ID (mm)	JOINT ID (mm)	WEIGHT (km/3m)	THREAD PITCH	PIN LENGTH (mm)	CONTENT (1/100m)
114.3	106.4	101.8	39.0	10.2	62.7	869.3

	PART #	DESCRIPTION
IMPERIAL	5008536	Rod, PHD 10' W-Wall

OD (in)	BODY ID (in)	JOINT ID (in)	WEIGHT (lb/10ft)	THREAD PITCH (TPI)	PIN LENGTH (in)	CONTENT (USgal/100ft)
4.50	4.19	4.00	82.50	2.50	2.47	71.00

W-WALL™ ROD BUNDLE SPECIFICATIONS

PHD 3.0 m/10 ft ROD BUNDLE (19 RODS)

Dimensions (L x W x H).....	3.2 x 0.40 x 0.30 m (10.3 x 1.2 x 1.1 ft)
Volume.....	0.40 m ³ (14.1 ft ³)
Gross Weight.....	268 kg (591 lb)

CONTAINER SHIPMENTS:

- 20 ft container load of 3.0 m/10 ft rods holds 30 bundles (210 rods)
- 40 ft container load of 3.0 m/10 ft rods holds 72 bundles (504 rods)

CASING

WT CASING 27

WT CASING

The WT casing is designed to surpass expectations for a casing and features a tapered HD thread allowing for multiple make and break cycles. The WT casing is made with DCDMA C80 compliant tubing and the tapered HD thread provides increased strength and easier make and break-out.

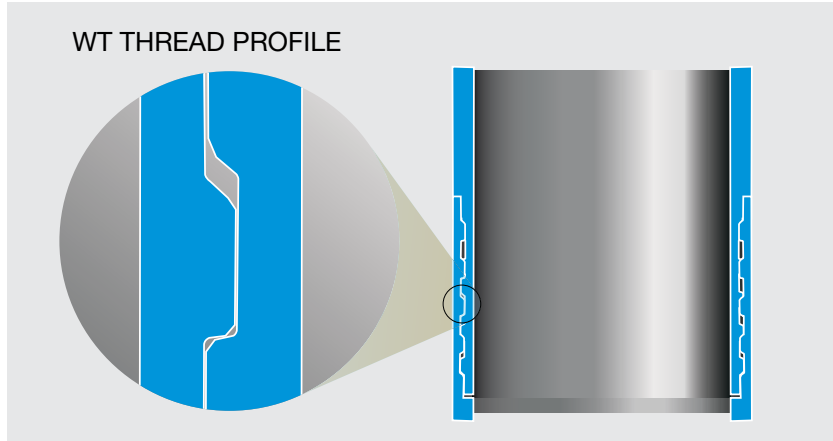

TUBING

- Parallel wall tubing compatible with Q™ wireline in-hole tools.
- Standard DCDMA sizing allows nesting between WT casing sizes.

THREAD DESIGN

- Larger deeper threads (2.5 threads per inch) provide maximum durability.
- Tapered joint and fewer threads per inch result in easier and faster make and break for multiple casing uses.
- Threads are easier to clean due to wider spacing of the threads for situations where casing is reused.
- Compatible with HD rod threads.

WT CASING PART NUMBERS

NWT

	PART #	DESCRIPTION
METRIC	5008513	NWT 3.0 m CASING
	5008787	NWT 1.5 m CASING

OD (mm)	ID (mm)	WEIGHT (kg/3m)	THREAD PITCH	PIN LENGTH (mm)	CONTENT (L/100m)
88.9	76.2	38.4	10.2	62.7	455.7

	PART #	DESCRIPTION
IMPERIAL	5008816	NWT 2 ft CASING

OD (mm)	ID (mm)	WEIGHT (kg/3m)	THREAD PITCH	PIN LENGTH (mm)	CONTENT (L/100m)
3.50	3.00	86.00	2.50	2.47	36.70

NWT BUNDLE SPECIFICATIONS

3.0 m/10 ft CASING BUNDLE (19 PIECES)

Dimensions (L x W x H).....3.2 x 0.5 x 0.4 m (10.3 x 1.5 x 1.3 ft)
 Volume.....0.6 m³ (21.0 ft³)
 Gross Weight.....760 kg (1,676 lb)

1.5 m/5 ft ROD BUNDLE (19 PIECES)

Dimensions (L x W x H).....1.6 x 0.5 x 0.4 m (5.3 x 1.5 x 1.3 ft)
 Volume.....0.3 m³ (11.0 ft³)
 Gross Weight.....390 kg (860 lb)

CONTAINER SHIPMENTS:

20 ft container load of 3.0 m/10 ft rods holds 20 bundles (380 rods)
 40 ft container load of 3.0 m/10 ft rods holds 26 bundles (494 rods)

WT CASING PART NUMBERS

HWT

	PART #	DESCRIPTION
METRIC	5008513	HWT 3.0 m CASING
	5008787	HWT 1.5 m CASING

OD (mm)	ID (mm)	WEIGHT (kg/3m)	THREAD PITCH	PIN LENGTH (mm)	CONTENT (L/100m)
114.3	101.6	52.2	10.2	44.4	810.8

	PART #	DESCRIPTION
IMPERIAL	55055	HWT 2 ft CASING

OD (mm)	ID (mm)	WEIGHT (kg/3m)	THREAD PITCH	PIN LENGTH (mm)	CONTENT (L/100m)
4.50	4.00	117.00	2.50	2.47	65.30

HWT BUNDLE SPECIFICATIONS

3.0 m/10 ft CASING BUNDLE (7 PIECES)

Dimensions (L x W x H).....	3.2 x 0.4 x 0.3 m (10.3 x 1.2 x 1.1 ft)
Volume.....	0.4 m ³ (14.1 ft ³)
Gross Weight.....	373 kg (823 lb)

1.5 m/5 ft ROD BUNDLE (7 PIECES)

Dimensions (L x W x H).....	1.6 x 0.4 x 0.3 m (5.3 x 1.2 x 1.1 ft)
Volume.....	0.2 m ³ (7.1 ft ³)
Gross Weight.....	194.1 kg (428 lb)

CONTAINER SHIPMENTS:

- 20 ft container load of 3.0 m/10 ft rods holds 30 bundles (210 rods)
- 40 ft container load of 3.0 m/10 ft rods holds 54 bundles (378 rods)

WT CASING PART NUMBERS

PWT

	PART #	DESCRIPTION
METRIC	3543977	PWT 3.0 m CASING
	3543976	PWT 1.5 m CASING

OD (mm)	ID (mm)	WEIGHT (kg/3m)	THREAD PITCH	PIN LENGTH (mm)	CONTENT (L/100m)
139.7	127.0	64.3	10.2	44.4	1266.6

	PART #	DESCRIPTION
IMPERIAL	3543973	PWT 2 ft CASING

OD (mm)	ID (mm)	WEIGHT (kg/3m)	THREAD PITCH	PIN LENGTH (mm)	CONTENT (L/100m)
5.50	5.00	144.00	2.50	2.47	102.00

PWT BUNDLE SPECIFICATIONS

NQ/NRQ 3.0 m/10 ft CASING BUNDLE (7 PIECES)

Dimensions (L x W x H).....	3.2 x 0.5 x 0.4 m (10.3 x 1.5 x 1.3 ft)
Volume.....	0.6 m ³ (21.2 ft ³)
Gross Weight.....	463 kg (1,022 lb)

1.5 m/5 ft ROD BUNDLE (7 RODS)

Dimensions (L x W x H).....	1.6 x 0.5 x 0.4 m (5.3 x 1.5 x 1.3 ft)
Volume.....	0.3 m ³ (10.6 ft ³)
Gross Weight.....	254 kg (560 lb)

CONTAINER SHIPMENTS:

- 20 ft container load of 3.0 m/10 ft rods holds 20 bundles (140 rods)
- 40 ft container load of 3.0 m/10 ft rods holds 44 bundles (308 rods)

TECHNICAL SPECIFICATIONS

Coring Rod Depth Rating	32
Coring Rod Torque Rating	33
Coring Rod Pullback Rating	34
ARQ TM TK	35
BQ TM	36
BRQ TM	37
BRQ TM TK	38
BXQ TM	39
NQ TM	40
NRQ TM	41
NXQ TM	42
NXQ TM W-Wall TM	43
HQ TM	44
HRQ TM	45
HXQ TM	46
HXQ TM W-Wall TM	47
PHD	48
PHD W-Wall TM	49

WIRELINE CORING RODS

DRILL ROD DEPTH RATING

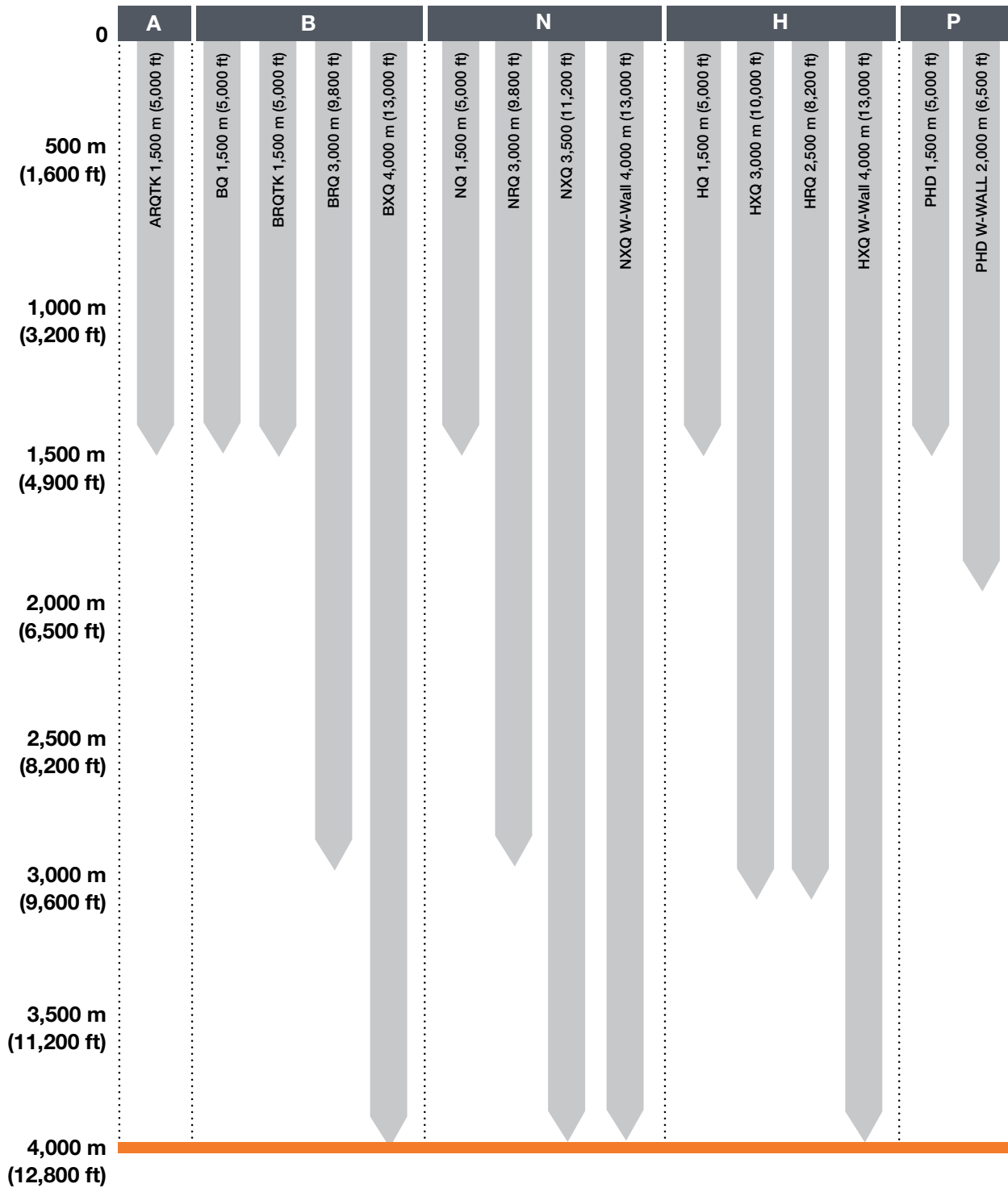

WARNING

- All ratings and recommendations are based on torque and tension load testing by an independent party.
- Depth and load capacities decrease with wear. For example, de-rate at least 50% for box shoulder thickness worn to 50% of original.
- Actual performance may vary depending on operating conditions and drilling practices.
- Increase make-up torque to match operating torque as depth increases. Operating torque should not exceed make-up torque.

WIRELINE CORING RODS

DRILL ROD JOINT MAX TORQUE RATING

TECHNICAL SPECIFICATIONS

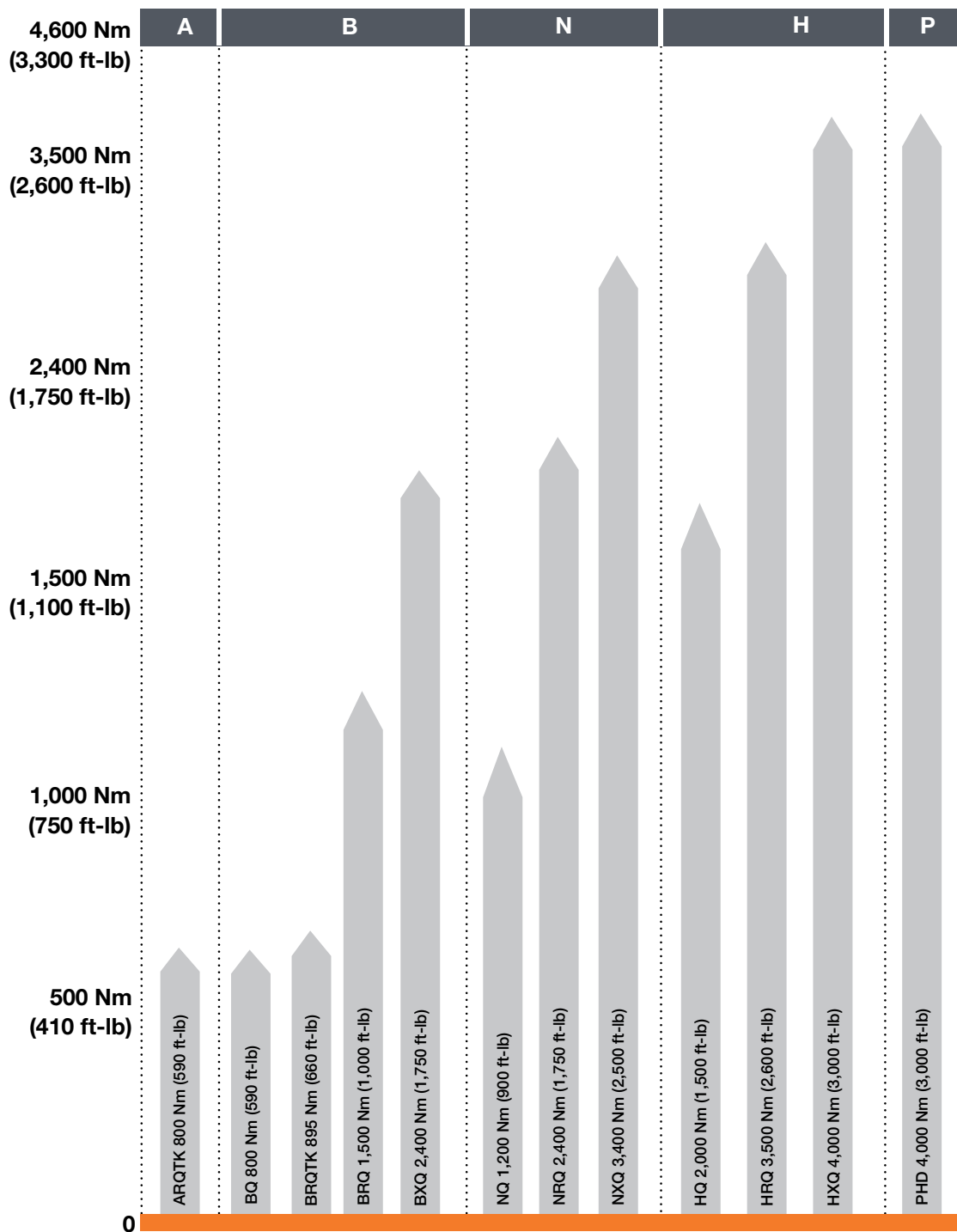

- All ratings and recommendations are based on torque and tension load testing by an independent party.
- Depth and load capacities decrease with wear. For example, de-rate at least 50% for box shoulder thickness worn to 50% of original.
- Actual performance may vary depending on operating conditions and drilling practices.
- Increase make-up torque to match operating torque as depth increases. Operating torque should not exceed make-up torque.

WIRELINE CORING RODS

DRILL ROD JOINT MAX PULLBACK RATING

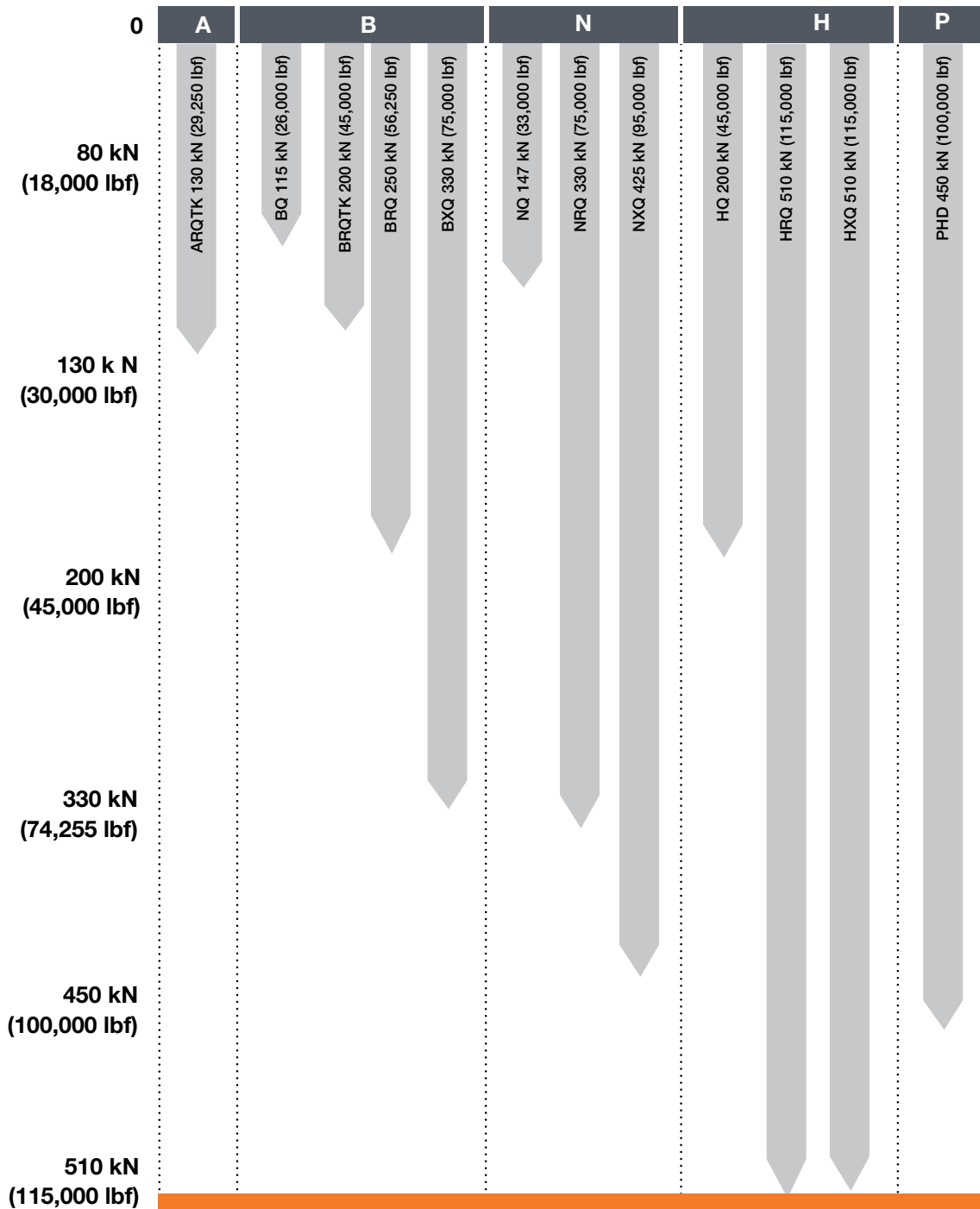

WARNING

- All ratings and recommendations are based on torque and tension load testing by an independent party.
- Depth and load capacities decrease with wear. For example, de-rate at least 50% for box shoulder thickness worn to 50% of original.
- Actual performance may vary depending on operating conditions and drilling practices.
- Increase make-up torque to match operating torque as depth increases. Operating torque should not exceed make-up torque.

TECHNICAL INFORMATION

ARQ™TK

PERFORMANCE RATING	METRIC	IMPERIAL
Rated Drilling Depth by Joint Strength	1,500 m	4,900 ft
Rated Maximum Pullback	130 kN	29,250 lb
Rated Maximum Torque (Operating or Make-Up)	800 Nm	590 ft-lb
Recommended Minimum Make-Up Torque for Deep Holes over 2000m	N/A	N/A
Recommended Minimum Make-Up Torque for Deep Holes over 1000m	381 Nm	281 ft-lb
Recommended Minimum Make-Up Torque	339 Nm	250 ft-lb
API Theoretical Burst Pressure at Box Shoulder (per API bulletin 5C3)	74,733 kPa	10,839 psi
API Theoretical Burst Pressure at Midbody (per API bulletin 5C3)	90,138 kPa	13,073 psi
API Theoretical Collapse Pressure at Midbody (per API bulletin 5C3)	94,464 kPa	13,700 psi

RATING CRITERIA	METRIC	IMPERIAL
Rod Midbody Outer Diameter	44.8 mm	1.76 in
Rod Midbody Inner Diameter	37.3 mm	1.47 in
Rod Joint Inner Diameter	37.3 mm	1.47 in
Rod Resistance to Deviation (Stiffness)	2538 mm ⁴	3.90 in ⁴
Rod Weight per Unit Length	3.77 kg/m	2.53 lb/ft
Rod Content Weight (Water) per Unit Length	1.1 L/m	0.09 gal/ft
Rod Displacement (Water) per Unit Length	0.5 L/m	0.04 gal/ft

*API burst and collapse ratings are intended for drilling and hydrostatic fluid pressure considerations only. For rod handling considerations, wrench or automated clamping jaws or roller gripping pressures must be limited to significantly lower values depending on the number of jaws or rollers and the gripping surface area and gripper tooth penetration, i.e. Always choose maximum number of jaws and maximum gripping area to minimize damage due to gripping pressure and to avoid crushing and fatigue failure.

NOTE: All rod capacities and failure loads were determined through simultaneous torque and tension load testing by an independent party. An appropriate safety factor has been applied in determining the ratings above. These ratings apply to new, unused rods of Boart Longyear manufacture, in a straight vertical down-hole, assuming compliance to Boart Longyear Care and Handling or Product Literature and standard core drilling practices. Actual performance may vary depending on operating conditions and drilling practices. Actual Burst and collapse pressure ratings will be reduced under drilling loads. Increase make-up torque to match operating torque in deep down-holes. Operating torque should not exceed make-up torque.

TECHNICAL INFORMATION

BQ™

PERFORMANCE RATING	METRIC	IMPERIAL
Rated Drilling Depth by Joint Strength	1,500 m	4,900 ft
Rated Maximum Pullback	115 kN	26,000 lb
Rated Maximum Torque (Operating or Make-Up)	800 Nm	590 ft-lb
Recommended Minimum Make-Up Torque for Deep Holes over 2000m	N/A	N/A
Recommended Minimum Make-Up Torque for Deep Holes over 1000m	504 Nm	416 ft-lb
Recommended Minimum Make-Up Torque	405 Nm	300 ft-lb
API Theoretical Burst Pressure at Box Shoulder (per API bulletin 5C3)	39,500 kPa	5,729 psi
API Theoretical Burst Pressure at Midbody (per API bulletin 5C3)	93,200 kPa	13,511 psi
API Theoretical Collapse Pressure at Midbody (per API bulletin 5C3)	97,300 kPa	14,117 psi

RATING CRITERIA	METRIC	IMPERIAL
Rod Midbody Outer Diameter	55.9 mm	2.19 in
Rod Midbody Inner Diameter	46.1 mm	1.81 in
Rod Joint Inner Diameter	46.1 mm	1.81 in
Rod Resistance to Deviation (Stiffness)	6,183 mm	9.60 in
Rod Weight per Unit Length	6.3 kg/m	4.20 lb/ft
Rod Content Weight (Water) per Unit Length	1.7 L/m	0.13 gal/ft
Rod Displacement (Water) per Unit Length	0.8 L/m	0.07 gal/ft

*API burst and collapse ratings are intended for drilling and hydrostatic fluid pressure considerations only. For rod handling considerations, wrench or automated clamping jaws or roller gripping pressures must be limited to significantly lower values depending on the number of jaws or rollers and the gripping surface area and gripper tooth penetration, i.e. Always choose maximum number of jaws and maximum gripping area to minimize damage due to gripping pressure and to avoid crushing and fatigue failure.

NOTE: All rod capacities and failure loads were determined through simultaneous torque and tension load testing by an independent party. An appropriate safety factor has been applied in determining the ratings above. These ratings apply to new, unused rods of Boart Longyear manufacture, in a straight vertical down-hole, assuming compliance to Boart Longyear Care and Handling or Product Literature and standard core drilling practices. Actual performance may vary depending on operating conditions and drilling practices. Actual Burst and collapse pressure ratings will be reduced under drilling loads. Increase make-up torque to match operating torque in deep down-holes. Operating torque should not exceed make-up torque.

TECHNICAL INFORMATION

BRQ™

TECHNICAL SPECIFICATIONS

PERFORMANCE RATING	METRIC	IMPERIAL
Rated Drilling Depth by Joint Strength	3,000 m	9,843 ft
Rated Maximum Pullback	250 kN	56,250 lb
Rated Maximum Torque (Operating or Make-Up)	1,500 Nm	1,100 ft-lb
Recommended Minimum Make-Up Torque for Deep Holes over 2000m	950 Nm	750 ft-lb
Recommended Minimum Make-Up Torque for Deep Holes over 1000m	680 Nm	500 ft-lb
Recommended Minimum Make-Up Torque	405 Nm	300 ft-lb
API Theoretical Burst Pressure at Box Shoulder (per API bulletin 5C3)	61,300 MPa	8,891 psi
API Theoretical Burst Pressure at Midbody (per API bulletin 5C3)	93,200 MPa	13,511 psi
API Theoretical Collapse Pressure at Midbody (per API bulletin 5C3)	97,300 MPa	14,117 psi

RATING CRITERIA	METRIC	IMPERIAL
Rod Midbody Outer Diameter	55.9 mm	2.19 in
Rod Midbody Inner Diameter	46.1 mm	1.81 in
Rod Joint Inner Diameter	46.1 mm	1.81 in
Rod Resistance to Deviation (Stiffness)	6,183 mm	9.60 in
Rod Weight per Unit Length	6.3 kg/m	4.20 lb/ft
Rod Content Weight (Water) per Unit Length	1.7 L/m	0.13 gal/ft
Rod Displacement (Water) per Unit Length	0.8 L/m	0.07 gal/ft

*API burst and collapse ratings are intended for drilling and hydrostatic fluid pressure considerations only. For rod handling considerations, wrench or automated clamping jaws or roller gripping pressures must be limited to significantly lower values depending on the number of jaws or rollers and the gripping surface area and gripper tooth penetration, i.e. Always choose maximum number of jaws and maximum gripping area to minimize damage due to gripping pressure and to avoid crushing and fatigue failure.

NOTE: All rod capacities and failure loads were determined through simultaneous torque and tension load testing by an independent party. An appropriate safety factor has been applied in determining the ratings above. These ratings apply to new, unused rods of Boart Longyear manufacture, in a straight verticle down-hole, assuming compliance to Boart Longyear Care and Handling or Product Literature and standard core drilling practices. Actual performance may vary depending on operating conditions and drilling practices. Actual Burst and collapse pressure ratings will be reduced under drilling loads. Increase make-up torque to match operating torque in deep down-holes. Operating torque should not exceed make-up torque.

TECHNICAL INFORMATION

BRQ™TK

PERFORMANCE RATING	METRIC	IMPERIAL
Rated Drilling Depth by Joint Strength	1,500 m	4,900 ft
Rated Maximum Pullback	200 kN	45,000 lb
Rated Maximum Torque (Operating or Make-Up)	895 Nm	660 ft-lb
Recommended Minimum Make-Up Torque for Deep Holes over 2000m	N/A	N/A
Recommended Minimum Make-Up Torque for Deep Holes over 1000m	680 Nm	500 ft-lb
Recommended Minimum Make-Up Torque	405 Nm	300 ft-lb
API Theoretical Burst Pressure at Box Shoulder (per API bulletin 5C3)	56,418 kPa	8,182 psi
API Theoretical Burst Pressure at Midbody (per API bulletin 5C3)	74,703 kPa	10,834 psi
API Theoretical Collapse Pressure at Midbody (per API bulletin 5C3)	72,506 kPa	10,516 psi

RATING CRITERIA	METRIC	IMPERIAL
Rod Midbody Outer Diameter	56.03 mm	2.20 in
Rod Midbody Inner Diameter	48.32 mm	1.90 in
Rod Joint Inner Diameter	48.32 mm	1.90 in
Rod Resistance to Deviation (Stiffness)	5,362 mm ⁴	8.30 in ⁴
Rod Weight per Unit Length	4.95 kg/m	3.30 lb/ft
Rod Content Weight (Water) per Unit Length	1.83L/m	0.15 gal/ft
Rod Displacement (Water) per Unit Length	0.76 L/m	0.06 gal/ft

*API burst and collapse ratings are intended for drilling and hydrostatic fluid pressure considerations only. For rod handling considerations, wrench or automated clamping jaws or roller gripping pressures must be limited to significantly lower values depending on the number of jaws or rollers and the gripping surface area and gripper tooth penetration, i.e. Always choose maximum number of jaws and maximum gripping area to minimize damage due to gripping pressure and to avoid crushing and fatigue failure.

NOTE: All rod capacities and failure loads were determined through simultaneous torque and tension load testing by an independent party. An appropriate safety factor has been applied in determining the ratings above. These ratings apply to new, unused rods of Boart Longyear manufacture, in a straight verticle down-hole, assuming compliance to Boart Longyear Care and Handling or Product Literature and standard core drilling practices. Actual performance may vary depending on operating conditions and drilling practices. Actual Burst and collapse pressure ratings will be reduced under drilling loads. Increase make-up torque to match operating torque in deep down-holes. Operating torque should not exceed make-up torque.

TECHNICAL INFORMATION

BXQ™

PERFORMANCE RATING	METRIC	IMPERIAL
Rated Drilling Depth by Joint Strength	4,000 m	13,000 ft
Rated Maximum Pullback	330 kN	75,000 lb
Rated Maximum Torque (Operating or Make-Up)	3,500 Nm	1,750 ft-lb
Recommended Minimum Make-Up Torque for Deep Holes over 2000m	950 Nm	750 ft-lb
Recommended Minimum Make-Up Torque for Deep Holes over 1000m	680 Nm	500 ft-lb
Recommended Minimum Make-Up Torque	405 Nm	300 ft-lb
API Theoretical Burst Pressure at Box Shoulder (per API bulletin 5C3)	61,300 MPa	8,891 psi
API Theoretical Burst Pressure at Midbody (per API bulletin 5C3)	93,200 MPa	13,511 psi
API Theoretical Collapse Pressure at Midbody (per API bulletin 5C3)	97,300 MPa	14,117 psi

RATING CRITERIA	METRIC	IMPERIAL
Rod Midbody Outer Diameter	55.9 mm	2.19 in
Rod Midbody Inner Diameter	46.1 mm	1.81 in
Rod Joint Inner Diameter	46.1 mm	1.81 in
Rod Weight per Unit Length	6.3 kg/m	4.20 lb/ft
Rod Content Weight (Water) per Unit Length	1.7 L/m	0.13 gal/ft
Rod Resistance to Deviation (Stiffness)	6,183 mm ⁴	9.60 in ⁴
Rod Displacement (Water) per Unit Length	0.8 L/m	0.07 gal/ft

*API burst and collapse ratings are intended for drilling and hydrostatic fluid pressure considerations only. For rod handling considerations, wrench or automated clamping jaws or roller gripping pressures must be limited to significantly lower values depending on the number of jaws or rollers and the gripping surface area and gripper tooth penetration, i.e. Always choose maximum number of jaws and maximum gripping area to minimize damage due to gripping pressure and to avoid crushing and fatigue failure.

NOTE: All rod capacities and failure loads were determined through simultaneous torque and tension load testing by an independent party. An appropriate safety factor has been applied in determining the ratings above. These ratings apply to new, unused rods of Boart Longyear manufacture, in a straight vertical down-hole, assuming compliance to Boart Longyear Care and Handling or Product Literature and standard core drilling practices. Actual performance may vary depending on operating conditions and drilling practices. Actual Burst and collapse pressure ratings will be reduced under drilling loads. Increase make-up torque to match operating torque in deep down-holes. Operating torque should not exceed make-up torque.

TECHNICAL INFORMATION

NQ™

PERFORMANCE RATING	METRIC	IMPERIAL
Rated Drilling Depth by Joint Strength	1,500 m	4,921 ft
Rated Maximum Pullback	147 kN	33,000 lb
Rated Maximum Torque (Operating or Make-Up)	1,200 Nm	900 ft-lb
Recommended Minimum Make-Up Torque for Deep Holes over 2000m	N/A	N/A
Recommended Minimum Make-Up Torque for Deep Holes over 1000m	1,000 Nm	750 ft-lb
Recommended Minimum Make-Up Torque	600 Nm	442 ft-lb
API Theoretical Burst Pressure at Box Shoulder (per API bulletin 5C3)	31,300 kPa	4,542 psi
API Theoretical Burst Pressure at Midbody (per API bulletin 5C3)	75,500 kPa	10,952 psi
API Theoretical Collapse Pressure at Midbody (per API bulletin 5C3)	73,900 kPa	10,724 psi

RATING CRITERIA	METRIC	IMPERIAL
Rod Midbody Outer Diameter	69.9 mm	2.75 in
Rod Midbody Inner Diameter	60.3 mm	2.38 in
Rod Joint Inner Diameter	60.3 mm	2.38 in
Rod Resistance to Deviation (Stiffness)	13,135 mm ⁴	20.40 in
Rod Weight per Unit Length	7.8 kg/m	5.20 lb/ft
Rod Content Weight (Water) per Unit Length	2.9 L/m	0.23 gal/ft
Rod Displacement (Water) per Unit Length	0.9 L/m	0.04 gal/ft

*API burst and collapse ratings are intended for drilling and hydrostatic fluid pressure considerations only. For rod handling considerations, wrench or automated clamping jaws or roller gripping pressures must be limited to significantly lower values depending on the number of jaws or rollers and the gripping surface area and gripper tooth penetration, i.e. Always choose maximum number of jaws and maximum gripping area to minimize damage due to gripping pressure and to avoid crushing and fatigue failure.

NOTE: All rod capacities and failure loads were determined through simultaneous torque and tension load testing by an independent party. An appropriate safety factor has been applied in determining the ratings above. These ratings apply to new, unused rods of Boart Longyear manufacture, in a straight vertical down-hole, assuming compliance to Boart Longyear Care and Handling or Product Literature and standard core drilling practices. Actual performance may vary depending on operating conditions and drilling practices. Actual Burst and collapse pressure ratings will be reduced under drilling loads. Increase make-up torque to match operating torque in deep down-holes. Operating torque should not exceed make-up torque.

TECHNICAL INFORMATION

NRQ™

PERFORMANCE RATING	METRIC	IMPERIAL
Rated Drilling Depth by Joint Strength	3,000 m	9,800 ft
Rated Maximum Pullback	330 kN	74,255 lb
Rated Maximum Torque (Operating or Make-Up)	2,400 Nm	1,750 ft-lb
Recommended Minimum Make-Up Torque for Deep Holes over 2000m	1,400 Nm	1,048 ft-lb
Recommended Minimum Make-Up Torque for Deep Holes over 1000m	1,000 Nm	750 ft-lb
Recommended Minimum Make-Up Torque	600 Nm	490 ft-lb
API Theoretical Burst Pressure at Box Shoulder (per API bulletin 5C3)	49,700 kPa	7,215 psi
API Theoretical Burst Pressure at Midbody (per API bulletin 5C3)	75,513 kPa	10,952 psi
API Theoretical Collapse Pressure at Midbody (per API bulletin 5C3)	73,943 kPa	10,724 psi

RATING CRITERIA	METRIC	IMPERIAL
Rod Midbody Outer Diameter	69.9 mm	2.75 in
Rod Midbody Inner Diameter	60.3 mm	2.38 in
Rod Joint Inner Diameter	60.3 mm	2.38 in
Rod Resistance to Deviation (Stiffness)	13,135 mm ⁴	20.40 in ⁴
Rod Weight per Unit Length	7.8 kg/m	5.23 lb/ft
Rod Content Weight (Water) per Unit Length	2.9 L/m	0.23 gal/ft
Rod Displacement (Water) per Unit Length	0.9 L/m	0.08 gal/ft

*API burst and collapse ratings are intended for drilling and hydrostatic fluid pressure considerations only. For rod handling considerations, wrench or automated clamping jaws or roller gripping pressures must be limited to significantly lower values depending on the number of jaws or rollers and the gripping surface area and gripper tooth penetration, i.e. Always choose maximum number of jaws and maximum gripping area to minimize damage due to gripping pressure and to avoid crushing and fatigue failure.

NOTE: All rod capacities and failure loads were determined through simultaneous torque and tension load testing by an independent party. An appropriate safety factor has been applied in determining the ratings above. These ratings apply to new, unused rods of Boart Longyear manufacture, in a straight vertical down-hole, assuming compliance to Boart Longyear Care and Handling or Product Literature and standard core drilling practices. Actual performance may vary depending on operating conditions and drilling practices. Actual Burst and collapse pressure ratings will be reduced under drilling loads. Increase make-up torque to match operating torque in deep down-holes. Operating torque should not exceed make-up torque.

TECHNICAL INFORMATION

NXQ™

PERFORMANCE RATING	METRIC	IMPERIAL
Rated Drilling Depth by Joint Strength	3,350 m	11,000 ft
Rated Maximum Pullback	425 kN	95,000 lb
Rated Maximum Torque (Operating or Make-Up)	3,400 Nm	2,500 ft-lb
Recommended Minimum Make-Up Torque for Deep Holes over 2000m	1,400 Nm	1,000 ft-lb
Recommended Minimum Make-Up Torque for Deep Holes over 1000m	1,000 Nm	750 ft-lb
Recommended Minimum Make-Up Torque	600 Nm	454 ft-lb
API Theoretical Burst Pressure at Box Shoulder (per API bulletin 5C3)	49,700 kPa	7,215 psi
API Theoretical Burst Pressure at Midbody (per API bulletin 5C3)	75,513 kPa	10,952 psi
API Theoretical Collapse Pressure at Midbody (per API bulletin 5C3)	73,943 kPa	10,724 psi

RATING CRITERIA	METRIC	IMPERIAL
Rod Midbody Outer Diameter	70.0 mm	2.75 in
Rod Midbody Inner Diameter	60.3 mm	2.38 in
Rod Joint Inner Diameter	60.3 mm	2.38 in
Rod Resistance to Deviation (Stiffness)	13135 mm ⁴	20.40 in
Rod Weight per Unit Length	7.8 kg/m	5.20 lb/ft
Rod Content Weight (Water) per Unit Length	2.9 L/m	0.23 gal/ft
Rod Displacement (Water) per Unit Length	0.9 L/m	0.04 gal/ft

*API burst and collapse ratings are intended for drilling and hydrostatic fluid pressure considerations only. For rod handling considerations, wrench or automated clamping jaws or roller gripping pressures must be limited to significantly lower values depending on the number of jaws or rollers and the gripping surface area and gripper tooth penetration, i.e. Always choose maximum number of jaws and maximum gripping area to minimize damage due to gripping pressure and to avoid crushing and fatigue failure.

NOTE: All rod capacities and failure loads were determined through simultaneous torque and tension load testing by an independent party. An appropriate safety factor has been applied in determining the ratings above. These ratings apply to new, unused rods of Boart Longyear manufacture, in a straight verticle down-hole, assuming compliance to Boart Longyear Care and Handling or Product Literature and standard core drilling practices. Actual performance may vary depending on operating conditions and drilling practices. Actual Burst and collapse pressure ratings will be reduced under drilling loads. Increase make-up torque to match operating torque in deep down-holes. Operating torque should not exceed make-up torque.

TECHNICAL INFORMATION

NXQ™ W-WALL™

PERFORMANCE RATING	METRIC	IMPERIAL
Rated Drilling Depth by Joint Strength	4,000 m	13,000 ft
Rated Maximum Pullback	425 kN	95,000 lb
Rated Maximum Torque (Operating or Make-Up)	3,400 Nm	2,500 ft-lb
Recommended Minimum Make-Up Torque for Deep Holes over 2000m	1,400 Nm	1,000 ft-lb
Recommended Minimum Make-Up Torque for Deep Holes over 1000m	1,000 Nm	750 ft-lb
Recommended Minimum Make-Up Torque	600 Nm	454 ft-lb
API Theoretical Burst Pressure at Box Shoulder (per API bulletin 5C3)	49,700 kPa	7,215 psi
API Theoretical Burst Pressure at Midbody (per API bulletin 5C3)	63,387 kPa	9,193 psi
API Theoretical Collapse Pressure at Midbody (per API bulletin 5C3)	52,421 kPa	7,603 psi

RATING CRITERIA	METRIC	IMPERIAL
Rod Midbody Outer Diameter	70.0 mm	2.75 in
Rod Midbody Inner Diameter	62.0 mm	2.44 in
Rod Joint Inner Diameter	60.3 mm	2.38 in
Rod Resistance to Deviation (Stiffness)	11,408 mm ⁴	17.70 in ⁴
Rod Weight per Unit Length	6.8 kg/m	4.50 lb/ft
Rod Content Weight (Water) per Unit Length	2.9 L/m	0.24 gal/ft
Rod Displacement (Water) per Unit Length	0.8 L/m	0.07 gal/ft

*API burst and collapse ratings are intended for drilling and hydrostatic fluid pressure considerations only. For rod handling considerations, wrench or automated clamping jaws or roller gripping pressures must be limited to significantly lower values depending on the number of jaws or rollers and the gripping surface area and gripper tooth penetration, i.e. Always choose maximum number of jaws and maximum gripping area to minimize damage due to gripping pressure and to avoid crushing and fatigue failure.

NOTE: All rod capacities and failure loads were determined through simultaneous torque and tension load testing by an independent party. An appropriate safety factor has been applied in determining the ratings above. These ratings apply to new, unused rods of Boart Longyear manufacture, in a straight vertical down-hole, assuming compliance to Boart Longyear Care and Handling or Product Literature and standard core drilling practices. Actual performance may vary depending on operating conditions and drilling practices. Actual Burst and collapse pressure ratings will be reduced under drilling loads. Increase make-up torque to match operating torque in deep down-holes. Operating torque should not exceed make-up torque.

TECHNICAL INFORMATION

HQ™

PERFORMANCE RATING	METRIC	IMPERIAL
Rated Drilling Depth by Joint Strength	1,500 m	4,900 ft
Rated Maximum Pullback	200 kN	45,000lb
Rated Maximum Torque (Operating or Make-Up)	2,000 Nm	1,500 ft-lb
Recommended Minimum Make-Up Torque for Deep Holes over 2000m	N/A	N/A
Recommended Minimum Make-Up Torque for Deep Holes over 1000m	1,200 Nm	900 ft-lb
Recommended Minimum Make-Up Torque	1,010 Nm	750 ft-lb
API Theoretical Burst Pressure at Box Shoulder (per API bulletin 5C3)	30,000 kPa	4,365 psi
API Theoretical Burst Pressure at Midbody (per API bulletin 5C3)	64,000 kPa	9,850 psi
API Theoretical Collapse Pressure at Midbody (per API bulletin 5C3)	60,000 kPa	8,770 psi

RATING CRITERIA	METRIC	IMPERIAL
Rod Midbody Outer Diameter	89.0 mm	3.50 in
Rod Midbody Inner Diameter	77.8 mm	3.06 in
Rod Joint Inner Diameter	77.8 mm	3.06 in
Rod Resistance to Deviation (Stiffness)	31,668 mm ⁴	49.10 in
Rod Weight per Unit Length	11.4 kg/m	7.70 lb/ft
Rod Content Weight (Water) per Unit Length	4.8 L/m	0.38 gal/ft
Rod Displacement (Water) per Unit Length	1.5 L/m	0.12 gal/ft

*API burst and collapse ratings are intended for drilling and hydrostatic fluid pressure considerations only. For rod handling considerations, wrench or automated clamping jaws or roller gripping pressures must be limited to significantly lower values depending on the number of jaws or rollers and the gripping surface area and gripper tooth penetration, i.e. Always choose maximum number of jaws and maximum gripping area to minimize damage due to gripping pressure and to avoid crushing and fatigue failure.

NOTE: All rod capacities and failure loads were determined through simultaneous torque and tension load testing by an independent party. An appropriate safety factor has been applied in determining the ratings above. These ratings apply to new, unused rods of Boart Longyear manufacture, in a straight verticle down-hole, assuming compliance to Boart Longyear Care and Handling or Product Literature and standard core drilling practices. Actual performance may vary depending on operating conditions and drilling practices. Actual Burst and collapse pressure ratings will be reduced under drilling loads. Increase make-up torque to match operating torque in deep down-holes. Operating torque should not exceed make-up torque.

TECHNICAL INFORMATION

HRQ™

PERFORMANCE RATING	METRIC	IMPERIAL
Rated Drilling Depth by Joint Strength	2,500 m	8,200 ft
Rated Maximum Pullback	510 kN	115,000 lb
Rated Maximum Torque (Operating or Make-Up)	3,500 Nm	2,600 ft-lb
Recommended Minimum Make-Up Torque for Deep Holes over 2000m	2,750 Nm	2,000 ft-lb
Recommended Minimum Make-Up Torque for Deep Holes over 1000m	2,000 Nm	1,500 ft-lb
Recommended Minimum Make-Up Torque	1,000 Nm	750 ft-lb
API Theoretical Burst Pressure at Box Shoulder (per API bulletin 5C3)	45,000 kPa	6,561 psi
API Theoretical Burst Pressure at Midbody (per API bulletin 5C3)	64,000 kPa	9,852 psi
API Theoretical Collapse Pressure at Midbody (per API bulletin 5C3)	60,000 kPa	8,772 psi

RATING CRITERIA	METRIC	IMPERIAL
Rod Midbody Outer Diameter	89.0 mm	3.50 in
Rod Midbody Inner Diameter	77.9 mm	3.06 in
Rod Joint Inner Diameter	77.9 mm	3.06 in
Rod Resistance to Deviation (Stiffness)	31,668 mm ⁴	49.10 in ⁴
Rod Weight per Unit Length	11.4 kg/m	7.70 lb/ft
Rod Content Weight (Water) per Unit Length	5.1 L/m	0.38 gal/ft
Rod Displacement (Water) per Unit Length	1.5 L/m	0.12 gal/ft

*API burst and collapse ratings are intended for drilling and hydrostatic fluid pressure considerations only. For rod handling considerations, wrench or automated clamping jaws or roller gripping pressures must be limited to significantly lower values depending on the number of jaws or rollers and the gripping surface area and gripper tooth penetration, i.e. Always choose maximum number of jaws and maximum gripping area to minimize damage due to gripping pressure and to avoid crushing and fatigue failure.

NOTE: All rod capacities and failure loads were determined through simultaneous torque and tension load testing by an independent party. An appropriate safety factor has been applied in determining the ratings above. These ratings apply to new, unused rods of Boart Longyear manufacture, in a straight vertical down-hole, assuming compliance to Boart Longyear Care and Handling or Product Literature and standard core drilling practices. Actual performance may vary depending on operating conditions and drilling practices. Actual Burst and collapse pressure ratings will be reduced under drilling loads. Increase make-up torque to match operating torque in deep down-holes. Operating torque should not exceed make-up torque.

TECHNICAL INFORMATION

HXQ™

PERFORMANCE RATING	METRIC	IMPERIAL
Rated Drilling Depth by Joint Strength	3,050 m	10,000 ft
Rated Maximum Pullback	510 kN	115,000 lb
Rated Maximum Torque (Operating or Make-Up)	4,000 Nm	3,000 ft-lb
Recommended Minimum Make-Up Torque for Deep Holes over 2000m	1,750 Nm	2,000 ft-lb
Recommended Minimum Make-Up Torque for Deep Holes over 1000m	2,000 Nm	1,500 ft-lb
Recommended Minimum Make-Up Torque	1,000 Nm	750 ft-lb
API Theoretical Burst Pressure at Box Shoulder (per API bulletin 5C3)	45,000 kPa	6,561 psi
API Theoretical Burst Pressure at Midbody (per API bulletin 5C3)	64,000 kPa	9,852 psi
API Theoretical Collapse Pressure at Midbody (per API bulletin 5C3)	60,000 kPa	8,772 psi

RATING CRITERIA	METRIC	IMPERIAL
Rod Midbody Outer Diameter	89.0 mm	3.50 in
Rod Midbody Inner Diameter	77.8 mm	3.06 in
Rod Joint Inner Diameter	77.8 mm	3.06 in
Rod Resistance to Deviation (Stiffness)	31,669 mm ⁴	49.10 in
Rod Weight per Unit Length	11.4 kg/m	7.70 lb/ft
Rod Content Weight (Water) per Unit Length	5.1 L/m	0.38 gal/ft
Rod Displacement (Water) per Unit Length	1.5 L/m	0.12 gal/ft

*API burst and collapse ratings are intended for drilling and hydrostatic fluid pressure considerations only. For rod handling considerations, wrench or automated clamping jaws or roller gripping pressures must be limited to significantly lower values depending on the number of jaws or rollers and the gripping surface area and gripper tooth penetration, i.e. Always choose maximum number of jaws and maximum gripping area to minimize damage due to gripping pressure and to avoid crushing and fatigue failure.

NOTE: All rod capacities and failure loads were determined through simultaneous torque and tension load testing by an independent party. An appropriate safety factor has been applied in determining the ratings above. These ratings apply to new, unused rods of Boart Longyear manufacture, in a straight verticle down-hole, assuming compliance to Boart Longyear Care and Handling or Product Literature and standard core drilling practices. Actual performance may vary depending on operating conditions and drilling practices. Actual Burst and collapse pressure ratings will be reduced under drilling loads. Increase make-up torque to match operating torque in deep down-holes. Operating torque should not exceed make-up torque.

TECHNICAL INFORMATION

HXQ™ W-WALL™

PERFORMANCE RATING	METRIC	IMPERIAL
Rated Drilling Depth by Joint Strength	4,000 m	13,000 ft
Rated Maximum Pullback	510 kN	115,000 lb
Rated Maximum Torque (Operating or Make-Up)	4,000 Nm	3,000 ft-lb
Recommended Minimum Make-Up Torque for Deep Holes over 2000m	2,750 Nm	2,000 ft-lb
Recommended Minimum Make-Up Torque for Deep Holes over 1000m	2,000 Nm	1,500 ft-lb
Recommended Minimum Make-Up Torque	1,000 Nm	750 ft-lb
API Theoretical Burst Pressure at Box Shoulder (per API bulletin 5C3)	45,500 kPa	6,458 psi
API Theoretical Burst Pressure at Midbody (per API bulletin 5C3)	50,200 kPa	7,280 psi
API Theoretical Collapse Pressure at Midbody (per API bulletin 5C3)	29,000 kPa	4,206 psi

RATING CRITERIA	METRIC	IMPERIAL
Rod Midbody Outer Diameter	88.9 mm	3.50 in
Rod Midbody Inner Diameter	81.0 mm	3.19 in
Rod Joint Inner Diameter	77.9 mm	3.06 in
Rod Resistance to Deviation (Stiffness)	24,592 mm ⁴	38.10 in ⁴
Rod Weight per Unit Length	9.1 kg/m	6.00 lb/ft
Rod Content Weight (Water) per Unit Length	5.1 L/m	0.40 gal/ft
Rod Displacement (Water) per Unit Length	1.1 L/m	0.09 gal/ft

*API burst and collapse ratings are intended for drilling and hydrostatic fluid pressure considerations only. For rod handling considerations, wrench or automated clamping jaws or roller gripping pressures must be limited to significantly lower values depending on the number of jaws or rollers and the gripping surface area and gripper tooth penetration, i.e. Always choose maximum number of jaws and maximum gripping area to minimize damage due to gripping pressure and to avoid crushing and fatigue failure.

NOTE: All rod capacities and failure loads were determined through simultaneous torque and tension load testing by an independent party. An appropriate safety factor has been applied in determining the ratings above. These ratings apply to new, unused rods of Boart Longyear manufacture, in a straight vertical down-hole, assuming compliance to Boart Longyear Care and Handling or Product Literature and standard core drilling practices. Actual performance may vary depending on operating conditions and drilling practices. Actual Burst and collapse pressure ratings will be reduced under drilling loads. Increase make-up torque to match operating torque in deep down-holes. Operating torque should not exceed make-up torque.

TECHNICAL INFORMATION

PHD

PERFORMANCE RATING	METRIC	IMPERIAL
Rated Drilling Depth by Joint Strength	1,500 m	4,900 ft
Rated Maximum Pullback	450 kN	100,000 lb
Rated Maximum Torque (Operating or Make-Up)	4,000 Nm	3,000 ft-lb
Recommended Minimum Make-Up Torque for Deep Holes over 2000m	N/A	N/A
Recommended Minimum Make-Up Torque for Deep Holes over 1000m	2,200 Nm	1,600 ft-lb
Recommended Minimum Make-Up Torque	1,000 Nm	750 ft-lb
API Theoretical Burst Pressure at Box Shoulder (per API bulletin 5C3)	21,614 kPa	3,135 psi
API Theoretical Burst Pressure at Midbody (per API bulletin 5C3)	62,038 kPa	8,998 psi
API Theoretical Collapse Pressure at Midbody (per API bulletin 5C3)	50,026 kPa	7,255 psi

RATING CRITERIA	METRIC	IMPERIAL
Rod Midbody Outer Diameter	114.4 mm	4.50 in
Rod Midbody Inner Diameter	101.4 mm	4.00 in
Rod Joint Inner Diameter	101.4 mm	4.00 in
Rod Resistance to Deviation (Stiffness)	80,423 mm ⁴	124.70 in ⁴
Rod Weight per Unit Length	17.4 kg/m	11.70 lb/ft
Rod Content Weight (Water) per Unit Length	8.1 L/m	0.65 gal/ft
Rod Displacement (Water) per Unit Length	2.2 L/m	0.17 gal/ft

*API burst and collapse ratings are intended for drilling and hydrostatic fluid pressure considerations only. For rod handling considerations, wrench or automated clamping jaws or roller gripping pressures must be limited to significantly lower values depending on the number of jaws or rollers and the gripping surface area and gripper tooth penetration, i.e. Always choose maximum number of jaws and maximum gripping area to minimize damage due to gripping pressure and to avoid crushing and fatigue failure.

NOTE: All rod capacities and failure loads were determined through simultaneous torque and tension load testing by an independent party. An appropriate safety factor has been applied in determining the ratings above. These ratings apply to new, unused rods of Boart Longyear manufacture, in a straight verticle down-hole, assuming compliance to Boart Longyear Care and Handling or Product Literature and standard core drilling practices. Actual performance may vary depending on operating conditions and drilling practices. Actual Burst and collapse pressure ratings will be reduced under drilling loads. Increase make-up torque to match operating torque in deep down-holes. Operating torque should not exceed make-up torque.

TECHNICAL INFORMATION

PHD W-WALL™

PERFORMANCE RATING	METRIC	IMPERIAL
Rated Drilling Depth by Joint Strength	2,000 m	6,500 ft
Rated Maximum Pullback	450 kN	100,000 lb
Rated Maximum Torque (Operating or Make-Up)	4,000 Nm	3,000 ft-lb
Recommended Minimum Make-Up Torque for Deep Holes over 2000m	3,500 Nm	2,500 ft-lb
Recommended Minimum Make-Up Torque for Deep Holes over 1000m	2,200 Nm	1,600 ft-lb
Recommended Minimum Make-Up Torque	1,000 Nm	500 ft-lb
API Theoretical Burst Pressure at Box Shoulder (per API bulletin 5C3)	21,700 kPa	3,145 psi
API Theoretical Burst Pressure at Midbody (per API bulletin 5C3)	38,849 kPa	5,634 psi
API Theoretical Collapse Pressure at Midbody (per API bulletin 5C3)	15,852 kPa	2,299 psi

RATING CRITERIA	METRIC	IMPERIAL
Rod Midbody Outer Diameter	114.0 mm	4.50 in
Rod Midbody Inner Diameter	106.0 mm	4.19 in
Rod Joint Inner Diameter	102.0 mm	4.00 in
Rod Resistance to Deviation (Stiffness)	53,739 mm ⁴	83.30 in ⁴
Rod Weight per Unit Length	37.3 kg/m	82.16 lb/ft
Rod Content Weight (Water) per Unit Length	8.8 L/m	0.70 gal/ft
Rod Displacement (Water) per Unit Length	2.2 L/m	0.17 gal/ft

*API burst and collapse ratings are intended for drilling and hydrostatic fluid pressure considerations only. For rod handling considerations, wrench or automated clamping jaws or roller gripping pressures must be limited to significantly lower values depending on the number of jaws or rollers and the gripping surface area and gripper tooth penetration, i.e. Always choose maximum number of jaws and maximum gripping area to minimize damage due to gripping pressure and to avoid crushing and fatigue failure.

NOTE: All rod capacities and failure loads were determined through simultaneous torque and tension load testing by an independent party. An appropriate safety factor has been applied in determining the ratings above. These ratings apply to new, unused rods of Boart Longyear manufacture, in a straight vertical down-hole, assuming compliance to Boart Longyear Care and Handling or Product Literature and standard core drilling practices. Actual performance may vary depending on operating conditions and drilling practices. Actual Burst and collapse pressure ratings will be reduced under drilling loads. Increase make-up torque to match operating torque in deep down-holes. Operating torque should not exceed make-up torque.

GUIDELINES FOR USE, CARE AND HANDLING

Guidelines for Use, Care & Handling	51
Make & Breaking Drill String	54
Rod Wear	60
Wear Gauges	62
Loads & Deviated Holes	63
Mid-Body Twisting	64

GUIDELINES FOR USE, CARE AND HANDLING

PACKAGING FEATURES:

- Drill rods and casing are packaged and sold in 'bundles' which offer product protection during shipping and handling.
- Protective caps cover box and pin threads sealing in thread lubrication.
- Heavy duty galvanized hexagon bundle end caps protect the drill rod ends.
- Drill rods are coated with rust inhibitor to reduce surface oxidation during shipping. When storing rods for long periods of time, it is recommended you reapply a rust inhibitor to protect the rods from oxidation. Avoid extended outdoor exposure to precipitation or high humidity to prevent ingress of moisture into rod mid-bodies which lack internal corrosion protection.

DRILL ROD APPEARANCE:

The color of the incoming tube depends on a combination of the following factors at the tubing mill:

- Formulation of their cold draw lubricant which gets pressed into the outer skin, e.g. zinc particulate, etc.
- The furnace atmosphere (gas) and temperature used in the annealing furnaces which reacts with the tubing surface and lubricant, e.g. nitrogen, argon, etc.
- Formulation of the rust preventative applied prior to shipment.

Color Q&T: Darker and bluish due to oxide formed from cooling in air. Color is a function of the temperature.

Color Pin Case: Darker and bluish due to oxide formed from cooling in air. Color is a function of the temperature.

Color Due to RP: Adds gloss or refraction color may appear slightly more yellow or amber.

Color Grease on Threads: Adds a light grey color to threads.

Final Appearance:



GUIDELINES FOR USE, CARE AND HANDLING

LUBRICATION AND CLEANING

Boart Longyear™ drill rod threads are coated with thread compound (anti-galling lubricant) for shipment from the factory. For initial use, it is neither necessary nor desirable to remove this thread compound unless contamination has occurred. Thereafter, clean and relubricate the threads with a Boart Longyear recommended compound (50% zinc particulate) after each use. Use enough compound to cover both thread and shoulder surfaces. A 40 to 50 mm (1.5 to 2 inch) brush is excellent for applying thread compound.



- Keep the compound and brush clean.
- While occasional mixing of the compound is recommended to avoid settling, dilution of any kind (e.g. diesel, gasoline or oil) will render the compound ineffective.

This thread compound is critical to wear life of the joint. In order to prevent wear, metallic particulate in the compound forms an interface layer that is able to withstand the contact pressure and prevent galling. A poor choice of compound or diluted compound will allow the mating surfaces to interact, resulting in adhesion or abrasion wear.

The thread compound is also critical to the strength of the joint. The interaction of the metallic particulate and the surface determines the frictional resistance to torque loads. This in turn determines how much torque is transferred through the joint versus how much is absorbed by the joint. A poor choice of compound or diluted compound will provide insufficient friction, leading to overload failure.

Compounds containing 50% zinc particulate generally provide a higher friction factor (higher torque capacity) and get better resistance than those containing similar amounts of copper, lead or graphite particulate. Environmentally friendly compounds must contain non-toxic, bio-stable, solid particles of similar properties and performance characteristics to that of typical zinc particles in order to perform.



- Use of grease without solid particulates will void the warranty. Metallic particulates will react in acidic water leading to hydrogen embrittlement and reduce fatigue life of the rods. Control and monitor drilling fluid acidity level. Never use low friction lubricants on rod joints.

In addition, lubricating the rod body with grease is recommended to reduce hole friction, drilling torque and mid-body wear.

NOTICE - PETROLEUM-BASED GREASE: THROUGHOUT THIS MANUAL, THE USE OF GREASE OR THREAD COMPOUNDS IS MENTIONED. IT IS IMPORTANT TO NOTE THAT THE USE OF PETROLEUM-BASED OR METAL BEARING LUBRICANT PRODUCTS IN SOME AREAS OF THE WORLD IS PROHIBITED. CONTACT YOUR BOART LONGYEAR REPRESENTATIVE FOR RECOMMENDED ALTERNATIVES.

GUIDELINES FOR USE, CARE AND HANDLING

PREPARATION FOR TRANSIT:

Always provide proper protection for thread ends. If available, reuse protective caps cover box and pin threads sealing in thread lubrication. If available, heavy duty galvanized hexagon bundle end caps can protect the drill rod ends during transit. Reapply a rust inhibitor to protect the rods from corrosion if the rods will be exposed to significant moisture. Load rods on at least three cross members and tie down with suitable chain or strap at end cross members. For long rods, an additional chain or strap should be provided in the middle.



Always provide proper protection for threaded ends.

WARNING

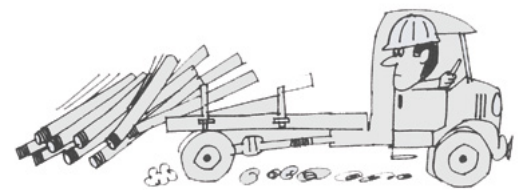

HE MAY BE **FAST** BUT WE'RE **FURIOUS!**

STORAGE OF DRILL RODS:

Always clean and grease the pin and box end threads of the rods before storing. Reuse protective caps cover box and pin threads sealing in thread lubrication. Heavy duty galvanized hexagon bundle end caps protect the drill rod ends. Store rods horizontally on a minimum of three cross supports on less than 30 cm (12 in) from the ground to keep moisture and dirt away from the rods.



Always provide proper protection for threaded ends.

WARNING



When rods are temporarily stacked in the mast or rod rack, always provide a wooden or rubber base to protect the pin ends. This is especially important when handling multiple length stands of 6 m (20 ft) or more.

Inspect used rods for bent mid-bodies and worn box shoulders regularly. Straighten or discard bent rods immediately as these cause vibration and can hamper drilling performance.

In addition to thread compound, a corrosion inhibitor on the body is recommended for long term storage (see packaging).



Due to the significant safety risk, Boart Longyear drill rods should never be mixed with another manufacturers' rods. Doing so may cause catastrophic equipment failure, leading to bodily injury or death. In addition, mixing rods voids the Boart Longyear warranty.

DANGER



MAKING AND BREAKING DRILL STRING

STABBING

Wireline drill rods and casing provide very little radial clearance when first inserting a pin end into a box end (stabbing). If the pin end is not aligned, it will stab into the box end shoulder causing permanent damage regardless of design or heat treatment. This damage will create leakage ranging from negligible to significant, depending on the degree of damage. Severe stabs can compromise the fit of the joint and potentially cause fatigue failures.

Once the face of the pin end shoulder is even with the face of the box end shoulder, the pin end should be lowered slowly into the box until the stab flank of the pin thread mates against stab flank of the box thread. If the pin is not true vertical alignment over the box or if the joint insufficient taper to allow the first turn of pin thread to clear the first turn of box thread, the pin thread crest may wedge or 'jam' against the box thread crest or begin to cross-thread. Rotating the connection counter-clockwise will correct misalignment.

Once successfully lowered, rotate the stabbing rod by hand to ensure proper thread engagement. It is recommended that a stabbing guide be utilized (e.g. Boart Longyear™ hoist plug and water swivel adapter subs have a bull nose lead-in feature to prevent stabbing damage).

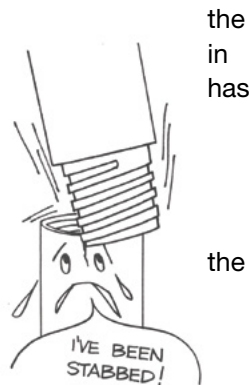

MAKE-UP

Wireline rods and casing make-up by slowly rotating the pin clockwise into the box (right hand threads). On most drills, this must be done at a very low rotation (e.g. 10 RPM or less) to avoid applying extraneous torque due to the inertia of the drill head. **Adjust the feed rate to match the rod thread (e.g. 3 threads per inch for Q rods versus 2 threads per inch for XQ) while maintaining light compression on the joint to minimize thread wear.** Do not allow tension, or excessive rotation speed, as this wears the thread load flanks.

If the stand-off gap, 0.8-2.0 mm (1/32" - 5/64"), is outside specification or if the joint does not close after applying a small amount of make-up torque, break-out the joint and clean and inspect both threads. This is an indication of excessive wear, excessive foreign material, or thread deformation due to overloading during making or breaking. It may also indicate that the product is from a different manufacturer.

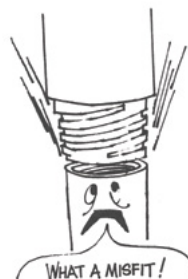

Due to the significant safety risk, Boart Longyear drill rods should never be mixed with another manufacturers' rods. Doing so may cause catastrophic equipment failure, leading to bodily injury or death. In addition, mixing rods voids the Boart Longyear warranty.

MAKING AND BREAKING THE DRILL STRING

MAKE-UP TORQUE (PRE-LOADING)

After the stand-off gap is closed, additional make-up is required to sufficiently pre-load the joint. While a large wrench may be sufficient on smaller sized rod strings or less demanding applications, make-up applied with the drill head or other power make-up devices is often required. This is to ensure the box shoulder does not become unloaded during drilling allowing leakage, fretting or premature fatigue failures. Joints will not self make-up sufficiently during drilling alone as the joint has additional frictional resistance to make-up under drilling loads.

Joints with insufficient make-up will begin to leak as the pullback load increases and the box shoulder relaxes. Another visual sign of insufficient make-up is pitting-wear in the joints due to fretting and in extreme cases, fatigue failures.

As a rule of thumb, the make-up torque on each joint should be adjusted to match the drilling torque it is expected to see. Additional make-up is required to maintain box shoulder compression under excessive pullback or twisting loads. However, note that excessive make-up reduces the available load capacity and fatigue strength.

ROD TYPE	MINIMUM MAKE-UP	
	NM	FT-LBS
ARQTK	350	250
BQ	400	300
BRQ/BXQ		
BRQTK		
NQ	600	450
NRQ/NXQ		
HQ	1000	750
HRQ/HXQ		
PHD	1000	750



WARNING Note: A common practice, in standard applications, is to apply 20% more make-up than drilling torque, however this takes away from the remaining load capacity and is not recommended for demanding applications.

The pin end is engineered to be slightly shorter than the box end to allow pre-loading of the box shoulder and elastic response to drilling loads. This is evident by a gap at the internal torque shoulder. Under extraordinary make-up or drilling torque, the pin and box will be sufficiently loaded to close this gap and engage the internal torque shoulder providing additional torque capacity.

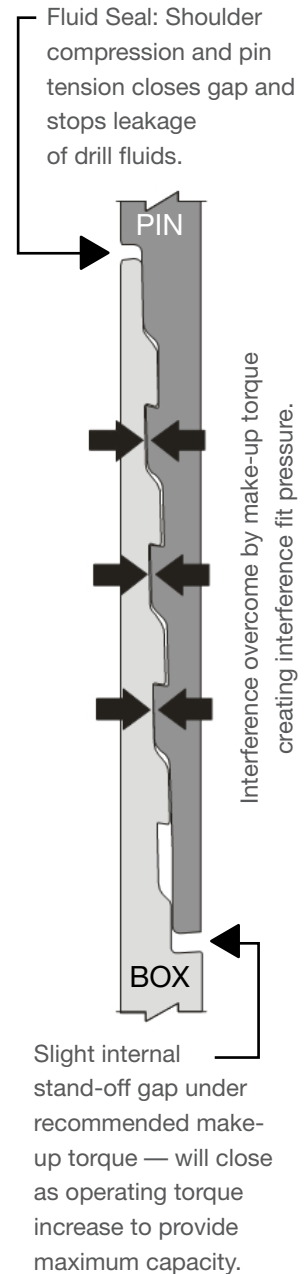

MAKING AND BREAKING THE DRILL STRING

TOP DRIVE SUBS

Special Considerations top-drive subs are subject to repeated makes and breaks during tripping, while each drill rod only sees a single make or break. Additionally, thick-wall adapter subs use heat treated alloy-steel bar, however, this bar is somewhat softer than mating drill rods. As a result, the torque shoulders are subject to wear after repeated makes against harder drill rod. Thus, top-drive adapters wear significantly faster than drill rods.

Adapter subs made with thick wall sections are significantly stiffer than the mating drill rods, causing higher stress and strain in the rods. The precisely engineered fit between the adapter and drill rod, are lost as the adapter wears. In combination with the difference in stiffness, the mating drill rod box can suffer premature fatigue failure when mated to a worn top-drive adapter.

Every effort has been made to reduce top-drive sub wear. Adapters intended for top-drive applications include the following features:

- Increased shoulder depths to resist wear and deformation from repeated makes & breaks.
- Bullnose guides to eliminate 'stabbing' shoulder damage during make-up.
- All thick-wall adapters will continue to feature male drill rod threads with case-hardening.

MANAGING TOP DRIVE SUB WEAR

Since they wear faster, plan to replace top-drive adapters regularly. The number of makes and breaks achieved will depend on drill rig make-up settings and the type and replenishment of thread compound. Consider using separate adapters for drilling (lower wear rate) from adapters used for tripping rods (higher wear rate).

HOW TO GAUGE SUB FIT WEAR

Manually make-up a spare locking coupling (or similar un-used rod box, coupling, or adapter, made by Boart Longyear) to the top-drive adapter, wrench-snug condition with thread compound applied, and measure or visually confirm that a 'stand-off' gap exists at the outer shoulder, approximately 0.5-2.0 mm (1/64"-3/32"). If no gap, or if the joint feels loose, then replace the adapter. If uncertain, compare to the fit on a spare un-used adapter sub, and reassess.

HOW TO GAUGE ADAPTER SHOULDER WEAR

After passing the wrench-snug fit test above, manually wrench the joint to a fully closed position. If the outer shoulder is not fully closed (visible gap) or has significantly worn or deformed (visible change in profile), then replace the dapter. If uncertain, compare to a spare un-used adapter sub, and reassess.

HOW TO GAUGE ADAPTER THREAD WEAR

RQ™ and XQ™ threaded adapters, use the new thread-profile go/no-go gauges to confirm the thread profile is providing performance benefits:

MAKING AND BREAKING THE DRILL STRING

LOWERING/INSERTING

The drill drive and hoist sheave must be aligned with the center line of the hole to prevent undue twisting and drag. The drill must also be well secured to the casing, ground or work face to ensure it does not load the rod string or become misaligned.

Adjust hollow spindle drive chucks and rod handling feed rollers to ensure that contact pressure is not permanently deforming or twisting mid-bodies, especially in the case of light weight rod strings. In order to avoid fracture failures, do not use feed rollers with carbide teeth, do not chuck on rod joints, and do not feed rod joints through feed rollers.

In down-holes always lower the rod string with the inner tube assembly latched in position. The inner tube assembly will act as a check valve in case the rod string is accidentally dropped.

BREAK-OUT

Theory and laboratory tests show that break-out torque should be 70-80% of the greater of make-up or drilling torque applied to each joint. Despite this, breaking-out may be problematic as some drill rigs do not have the same load capacity in breaking as they do in making-up or drilling. Additionally, during drilling, the joints may be subject to vibration allowing incremental make-up. Note that a poor choice of thread compound will contribute to this effect as well. This may result in a break-out torque requirement that exceeds the original make-up applied. This can be overcome utilizing the same effect by applying a slight percussive blow to the side of the box with a rubber mallet or similar non-damaging tool. Do not use a metal hammer or similarly hard objects. They will affect material properties in the impacted area potentially cause fatigue failures and may void the Boart Longyear warranty.

On down-hole applications of significant depth, prior to breaking-out, ensure that the drill rig foot-clamp is holding the rod string weight and that any tension across the joint (between the drill head and foot clamp) has been relieved. This eliminates undue thread wear and a potential safety hazard on deep-holes; the pin should not 'jump' out of the box on break-out.

Once the threads have disengaged, the pin can be slowly lifted. Cleaning and re-lubricating is recommended to minimize wear.

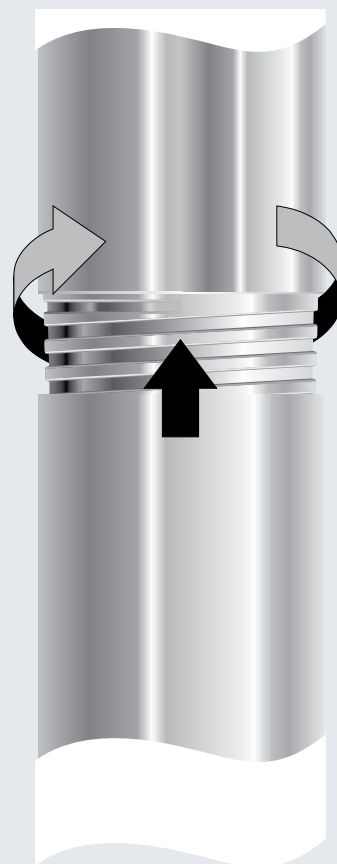
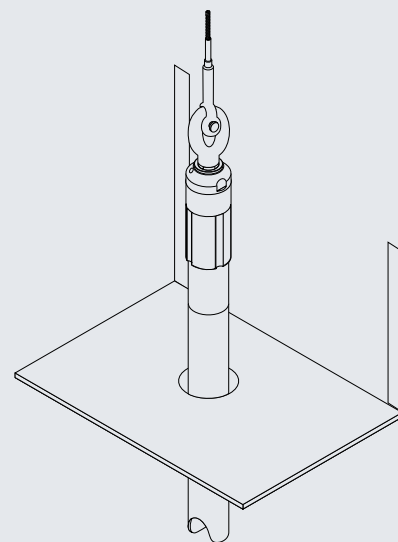

MAKING AND BREAKING THE DRILL STRING

FLUID SEAL

Conventional and wireline drill rods and casing utilize steel-on-steel interfaces as a fluid seal. Make-up torque is required to load the box end shoulder face against the pin external shoulder face to develop the necessary contact pressure at the mated interface. Given the high elastic modulus of steel, the performance of these seals is very limited regardless of face geometry or heat treatment. As a result, the fluid seal is very sensitive to damage on either shoulder face.

NOTE: Chucking on or applying wrenches to either shoulder will cause leakage.

The sealing performance of a rod string in a down-hole can be evaluated with a pressure test:

- Drop an inner tube assembly adjusted to zero-bit-gap such that the weight of the column of fluid above the inner tube will create a seal between the core lifter case and the bit.
- Run the fluid supply pump until maximum pressure is achieved and then close the valve between the rod string and pump.
- Monitor the fluid pressure gauge and record any drop in pressure over a time interval. The amount of flow loss can be calculated using standard pressure vessel formula.
- While no drop in pressure should occur on a new string, only a complete loss of pressure in less than one minute is significant.

EXAMPLE:

An 1,800 m (5,900 ft) string of NQ™ rod that loses 14 MPa (200 psi) in one minutes is only losing 7 lpm (1.6 gpm) where the minimum recommended flow for an NQ bit is 30 lpm (8 gpm).

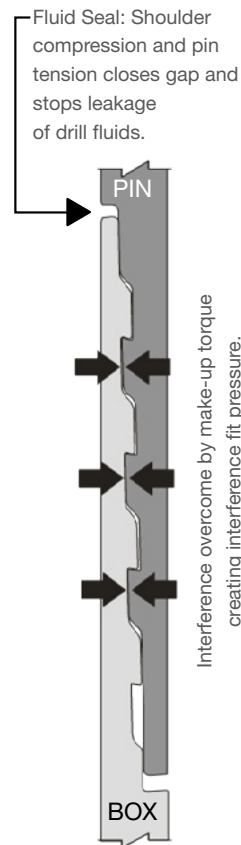

ROD SEAL INSTALLATION

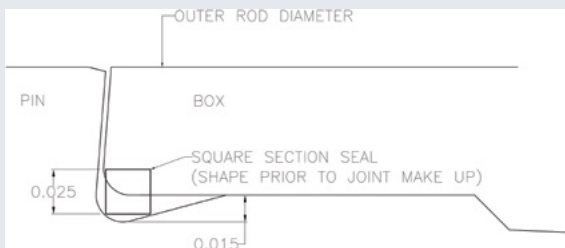

ROD JOINT SEALS

5008777	SEAL, BRQ/BXQ R/P
3545024	SEAL, NRQ/NXQ R/P
3545025	SEAL, HRQ/HXQ R/P



Note: Due to the care required in installation Boart Longyear does not guarantee sealing performance nor does it guarantee seal compatibility with fluids used.



Mag-Grip Rod Lifter PART#: 5009525

- Safely pick up sharp or dirty tubing without touching it
- Pipe groove for easy alignment and maximum strength transporting various size pipe
- Ergonomic pivot handle with set-screw makes the pivot feature optional, easily changed from fixed to pivoting and vice-versa
- Simple 180 degree turn of a handle to activate or release the magnet with a locking mechanism that prevents accidental release
- CE certified

CARE AND HANDLING

THREAD WEAR

The wear of sliding steel-on-steel surfaces, such as in a rod or casing joint, commonly referred to as galling, mainly consists of adhesion and abrasion wear as a result of making and breaking. While some wear can be tolerated without compromising performance, worn surfaces are prone to further wear. If unattended, the degree of wear can worsen to the point where it can cause premature failure or, in the case of mating surfaces or similar hardness, seize the joint. Additionally, a worn thread can damage a good thread.

The rate of wear to be expected in a sliding metal-to-metal system can only be determined by considering all of the following variables:

- Lubrication
- The hardness of the softer surface
- The distance of contact slide
- The contact load or pressure

Less wear can be achieved by:

- Cleaning and lubricating joints regularly; preferably after every break. Dry lubrication coatings are available but these wear off and must also be cleaned and lubricated.
- Choosing joints with mating surfaces of dissimilar hardness. Published data shows that given equal contact pressures and equal hardness on the softer surfaces, a system with a harder mating surface (dissimilar hardness) can provide several times the wear life.
- Choosing joints with dissimilar hardness and with greater hardness on the softer thread such as on RQ and XQ rod joints.
- Reduce the sliding contact distance by choosing joints with greater taper.
- Reduce the contact pressure by choosing an XQ™ joint with double-start threads.
- Minimize the contact pressure by adjusting the feed rate and rotation speed during make and break to match the thread pitch and compensate for rod and drill head weight.
- Ensure there is light compression during joint make-up. Do not allow tension, or excessive rotation speed, as this wears the thread load flank.

Another source of rod joint wear is worn accessories. All threaded accessory equipment, such as Kelly (drive) rods, drive head adapter subs, hoist plugs, water swivels and cross-over adapter subs should be inspected prior to use to ensure they are in good condition. Use only genuine Boart Longyear™ accessories to ensure proper fits and maximum wear life. Boart Longyear tooling and gauging adhere to a high global standard.

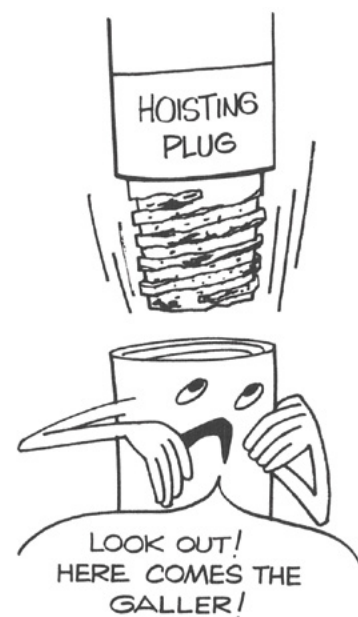

CARE AND HANDLING

BOX WEAR

In many applications the cause of retirement of a drill rod is due to localized wear resulting from the deformation of the box out of a 'flush' position.

In Q joints, it is inherent for the box and box end shoulder to elastically deform radially or 'bulge'. This is due to radial and hoop stresses imposed by conventional thread forms which add to drilling load stresses. This is evident by a thin section in the box should and/or a small polished area on the side of the joint where thread engagement begins. As the wear progresses, the box becomes weaker and the deformation more pronounced, increasing the wear rate. Given sufficient contact pressure and speed, the heat generated between the rod string and casing or hole can cause heat-check cracking which ultimately appears as an axial crack, typically on the box end.

- Check make-up torque to ensure it is at least minimum, but not more than required. Higher make-up torque increase bulging in Q rods.
- Move to RQ joints which mimic the load response of a solid tube in that radial and hoop stresses imposed by the thread subtract from drill load stresses, reducing 'bulging'.
- If already on RQ threads move to XQ threads, whose dual start threads and increased torque capacity reduce box wear even further.

MIDBODY WEAR

All rod strings are un-stable and, in response to drilling loads, elastically buckle into a three dimensional helical shape, a phenomenon first identified and defined by Boart Longyear as 'helical whirling'. As loads or rotation increase, and in deviated drilling applications, the lateral contact pressure between the string and the casing or hole increases contributing to an increased mid-body wear rate. Do not exceed rod deviation ratings.

The use of 'rod grease' and drilling fluid additives to reduce friction and wear between the rod string and the casing or hole is common however the only effective solution to reduce mid-body abrasion wear is to reduce lateral loads, either by changing RPM, reduce weight on bit or re-cut hole deviations.



BOX OUTER DIAMETER SHOULDER WEAR GAUGE ORDERING INFORMATION

- 5008852 GAUGE, BQ/BRQ/BXQ R/B OD WEAR
- 5008857 GAUGE, NQ/NRQ/NXQ R/B OD WEAR
- 5008862 GAUGE, HQ/HRQ/HXQ R/B OD WEAR
- 5003593 GAUGE, PHD R/B OD WEAR

CARE AND HANDLING

BOX OUTER DIAMETER SHOULD WEAR GAUGE

The 'box' or female end of the drill rod joint is subject to abrasive wear against the wall of the drill hole. As the shoulder decreases in thickness, the load capacity of the joint is reduced. This 'go/no-go' gauge determines whether a particular portion of the shoulder has retained 60% of its original thickness. The ends of the wear gauge are labelled 'GO' or 'NO-GO'. A curved groove is cut into each end of the gauge with a radius that matches that of the drill rod joint.

Ascertain the portion of the box with the least thickness by visual inspection. A thin section will become pronounced as joints respond to large torque or pullback loads and wear against the hole.

Attempt to insert the thinnest portion of the box shoulder into the 'NO-GO' end of the gauge.

If the box will insert into the gauge, there is less than 60% of the original shoulder thickness remaining. This means that the joint's load capacity has been significantly compromised. The rod should be considered for retirement and the remainder of the rod string should be inspected.

If the box will not insert into the gauge, there is more than 60% of the shoulder thickness remaining and the majority of the joint's load capacity is available.

Insert the thinnest portion of the box shoulder into the 'GO' end of the gauge. The amount of radial movement or 'play' will allow the operator to estimate the amount of wear that has taken place or the amount of wear life remaining. If the box shoulder will not insert into the gauge, the box is in a 'new' condition and has greater than nominal thickness due to tubing mill tolerance.

REVERSE FLANK THREAD WEAR GAUGE

ORDERING INFORMATION

5008766	GAUGE, BRQ R/B THREAD WEAR
5008852	GAUGE, BXQ R/B THREAD WEAR
5008768	GAUGE, NRQ R/B THREAD WEAR
5008857	GAUGE, NXQ R/B THREAD WEAR
5008770	GAUGE, HRQ R/B THREAD WEAR
5008862	GAUGE, HXQ R/B THREAD WEAR



REVERSE THREAD WEAR GAUGE

Due to its lesser hardness, the box thread accepts virtually all of the wear when made and broken against the pin thread. During make and break, the box thread should only have contact on the 'root' or minor diameter and on the 'stab' or 'clearance' flank. If the 'load' flank has deformed or worn in error, it may lead to failures. This 'go/no-go' gauge determines whether the load flank portion of the thread form has retained its original shape sufficient to provide its 'RQ™' and 'XQ™' low-stress & anti-bulge features.

1. Mate the gauge with the box threads such that the outer diameter shoulders are not in contact.
2. Slide the gauge along the threads until the shoulders mate and apply hand pressure to ensure it stays in place.
3. Try to pry the gauge off of the threads. If the gauge cannot be removed (without 'unthreading'), the box thread form is intact. This means that the make and break set up on the rig is good and the joint has retained full load capacity. If the gauge is removable (without 'unthreading'), the box thread load flank has been deformed. This means that the make and break set up is incorrect, the joint's load capacity has been reduced, and XQ™ features are lost. Consider retirement and inspect the remainder of the rod string.

CHECKING SIZE OR FIT

If any concerns arise during make-up either with subs or used rods, the best practice is to use a new rod end to check fit.

CARE AND HANDLING

FATIGUE LOADS AND DEVIATED HOLES

Fatigue failures are brittle cracks that occur at load levels that are significantly below static ratings; however, the loads are applied or cycled a large number of times. An example everyone can relate to is flexing a paper clip back and forth until it breaks. Due to the reduced cross-sections of material in the threaded ends, the joints between mated rods in the string are significantly weaker than the rod mid-bodies and is the typical location of failure under an excessive cyclic load. Fatigue failures always occur perpendicular to the cyclic load or stress. Therefore the most common failure is a circumferentially oriented crack which indicates that the cyclic load or stress was axially oriented, caused by twisting.

This type of load occurs when drilling in a deviated hole, where the surface of the rod undergoes both tension and compression in each revolution. In steel materials, there is a well defined stress limit below which it should not fail. Deviation guidelines are developed to keep the rods below this limit, though they do not consider depth and torque. Fatigue failures can be avoided by limiting the level of cyclic loads in consideration of the pullback load. As stiffness varies with rod size follow the deviation guidelines in the table below. If Dog Leg Severity (DLS) is not provided with survey results, it can be calculated using formula in the illustration below. It is not the dip and azimuth added together.

DEVIATION GUIDELINES

MAXIMUM DEGRESS PER ROD LENGTH*

ARQ™TK	2.0 deg
BXQ™/BRQ/BRQTK	1.5 deg
BQ™	1.2 deg
NXQ W-WALL™/NRQ	1.0 deg
NQ™	0.8 deg
HXQ W-WALL/HRQ	0.8 deg
HQ/PHD/PHD W-WALL	Not Recommended

*Reduce deviation for excessive pullback applications, i.e. deep-holes

- Limit the build angle or rate of hole deviations checking that the deviation rating per rod length is not exceeded rather than the deviation per 30 m (100 ft).
- Deviation should be further limited with increasing hole depth.
- Re-cut or ream out any sections that exceed deviation or add significant torque.
- Place bends as close to bottom as possible to limit stress.
- Lubricate rods to minimize friction and torque.
- Check rods for polishing; retire any rods worn thin or showing fine cracks (heat-check cracking).

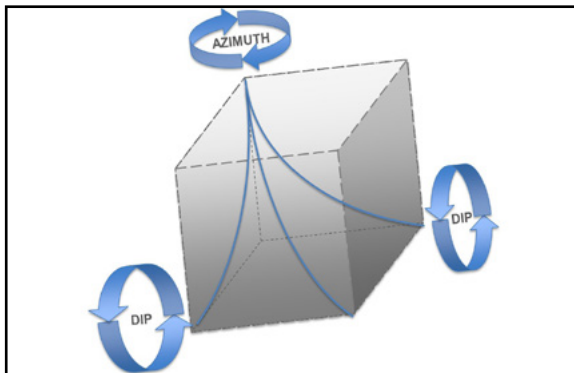

The twisting of the rod string in 3D space, or the angle between two survey points. More precisely, it is the angle between the two tangent vectors at those points. The formula below provides reasonable results:

$$\text{Dogleg angle} = \cos^{-1} [\cos(\text{azimuth change}) \sin(\text{final dip}) \sin(\text{initial dip}) + \cos(\text{final dip}) \cos(\text{initial dip})]$$



WARNING Note: Standard weight wireline drill rods have limited deviation capacity. Lightweight or internally upset rods are recommended for greater deviation.

CARE AND HANDLING

ROD MID-BODY TWISTING

Mid-body twisting (aka bending) has occurred since the development of coring rod and is not the result of a quality defect. Modeling, testing and experience has shown that all rod strings are unstable and elastically buckle into a helical shape under normal loading. Whether the rod returns to straight or permanently twists depends on a number of variables, which are difficult to predict.

Work done in the early 2000's sought to improve rods resistance to twisting. Benchmarking tests, confirmed by neutron diffraction testing, showed that the residual stress induced by roll rod straightening during tube manufacture reduced resistance to twisting. As a result, new annealing processes and validation test equipment were developed to minimize residual stress. Once the optimal annealing process was developed, twisting resistance improved significantly.

Twisted mid-bodies are the result of complex dynamic loading, at least in part due to natural harmonics, similar to breaking wine glasses with sound. It is important to note that a driller will not directly observe the twisted helical shape, instead he would observe increased vibration and torque (the helical shape can sometimes be revealed in video recordings).

Both computer modeling and field tests have been used to identify the influencing factors of rod twisting. As part of these tests, special super high strength prototypes were tested alongside normal rod, and rods without annealing to see if they could withstand a twisting event. Under dynamic loading, all the rods twisted and poorly annealed rods twisted more. Rod string dynamics are severe enough that it will always be possible to twist drill rod. The important variables are as follows:

RPM: Higher rotation speed (higher energy) makes it easier to twist rods, but rods can still twist at lower speed. Speed adjustments can have a significant influence by avoiding harmonic resonance of the rod string, which changes the hole depth. In one example, adjusting rod rotation only 50 RPM has been shown to reduce torsional vibration by a factor of five.

Drilling Fluid: Drilling fluids dampen out vibration. Instances of lost circulation allow for increased vibration and side wall friction, both of which increase the likelihood of a twisting event.

Hole Angle: Increases in hole angle generate more side wall friction, increasing the likelihood of a twisting event.

Hole Clearance: Running oversize bits or using large diameter casing allows space for a larger corkscrew to form and increases the likelihood of a twisting event.

Trajectory: Changes in dip and azimuth ('dog legs') greatly contribute to rod friction and stress. For example, deviations exceeding 1 degree per rod length (10 degrees in 30 m) can produce side wall friction sufficient to trigger a twisting event, and fatigue loading sufficient to cause fatigue failure. Do not exceed guidelines.

Minor improvements to drilling methods can reduce likelihood of mid-body twisting:

- Minimize drill rod friction, e.g. fluid circulation with additives, greased rod string, etc.
- Monitor and minimize vibration by adjusting speed up or down when encountering harmonic resonance (very important).
- Minimize and monitor deviation, in both dip and azimuth, and correct when necessary.

While it is common to accurately control dip as the primary way to stay on target, azimuth change also plays an important role in deviation. Directional stability can be increased by adopting use of full-hole outer tubes, free-cutting bit formulas, taller crown bits such as Stage™ bits, and dual length shells. Once a severe dog leg is cut, there may not be any prevention of twisting without corrective reaming or changing hole direction.

CARE AND HANDLING

ROD MID-BODY TWISTING

When increasing torque and vibration is observed, and does not go away with changes in parameters, it is likely some rods are permanently bent. The string needs to be checked and any twisted rods removed to prevent further twisting and getting stuck in the hole. Assuming there is no other damage, like fatigue cracks, twisted rods can be returned to original performance by straightening.

DRILL ROD STRAIGHTENING PROCEDURE EQUIPMENT REQUIREMENTS: HYDRAULIC PRESS, 1 SET OF ROLLERS; DIAL INDICATOR WITH MAGNETIC BASE.

1. Mark the mid-point of a 3m drill rod with a marking pen and position the rod into the hydraulic press so that the mid-point is directly below the hydraulic ram. The rod should be supported by the rollers, which should be spaced so that they are close to the either side of the hydraulic press frame.
2. Locate the dial indicator so that the measuring probe is on the middle of the drill rod adjacent to the marking.
3. Rotate the rod by hand to locate the high spot. Typically one revolution of the needle on the dial gauge is 1mm. The high spot is then marked and positioned directly below the hydraulic ram.
4. Down on the centre of the rod to deflect the rod downwards and in the opposite direction of the bend. Some trial and error is necessary to determine how much reverse bending is necessary to straighten the rod. Try bending in increments of approximately 5mm to begin with. After straightening a few rods, a pattern will develop showing how much force is necessary to straighten.
5. After one deflection, release the hydraulic pressure and rotate the rod, using the dial indicator to see how much of the bend has been removed. Aim for a run-out of 1 mm in a 2m span or less, which is approximately the allowable tolerance of a new rod. If the run-out is still higher, repeat the pressing procedure whilst applying additional downwards force.

This procedure straightens the middle section of the drill rod only, which is usually where the majority of bending occurs and which is the easiest to remove. Rods can normally be returned to satisfactory use after performing this straightening procedure.



TROUBLESHOOTING

Stand-Off Gap & Leakage	67
Fatigue Failure	68
Premature Box End Cracking	69
Thread Wear or Galling	70
Box Wear/ Box Bulging/ Thread Jumping	71
External Shoulder Wear	72
Mid-Body Wear & Fatigue Failure	72
Rod Twisting	73

TROUBLESHOOTING

Proper use and handling of coring rods in the field leads to lower rod and operational costs in the long run. Rods are typically only 3% of total drilling costs, whereas fishing a dropped string for one week would represent a 2% increase in operating costs. Re-drilling a hole for one month would result in a 9% increase of operating costs.

STAND-OFF GAP EXCESSIVE OR DOES NOT CLOSE UPON MINIMAL MAKE-UP OR DIFFICULTY BREAKING OUT

Potential Causes and Corrective Actions

1. Clean and inspect threads for excessive foreign or wear debris. Accelerated wear may be due to damaged accessories; inspect accessories (e.g. adapter subs).
2. Rods are of different manufacture. Separate all rods by manufacturer and do not interchange RQ™ style joints, Boart Longyear's exacting design and fit of wirelines rod joints is held proprietary. Also, patented XQ™ rod joints are only offered by Boart Longyear. ⚠
3. Hand tools should be sufficient to close the stand-off gap. Use hydraulic tools, such as a drill chuck or head to apply the minimum make-up torque required.
4. Threads are excessively worn or deformed from poor set-up for make or break, or from overload. Inspect string for damage and discard rods with deformed threads. Overload or difficult breaking may be due to poor choice of thread compound (see lubrication and cleaning and break-out).
5. Deformation due to hammering damage (see break-out) or stabbing damage (see stabbing). Inspect string and discard damaged rods.

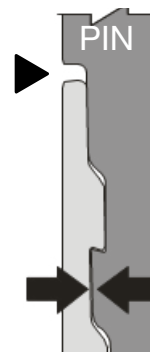

LEAKAGE

Potential Causes and Corrective Actions

1. Rods run in loose (joints not closed) due to insufficient make-up or to excessive stand-off gap (see causes of excessive stand-off above).
2. The pin or box outer diameter shoulder face has stabbing or handling damage.
3. Outer shoulder contact pressure distribution is uneven due to poor fit. Threads are significantly worn or deformed from overload or excessive load during make and break or shoulders are deformed from overload. Overload may be due to poor choice of thread compound.
4. Box wear life exceeded. Inspect string for excessive wear. Consider upgrading to XQ™ rods.
5. Rods are of different manufacture. Separate all rods by manufacturer and do not interchange. RQ™ style joints, Boart Longyear's exacting design and fit of wireline rod joints is held proprietary. Also, patented XQ™ rod joints are only offered by Boart Longyear. ⚠

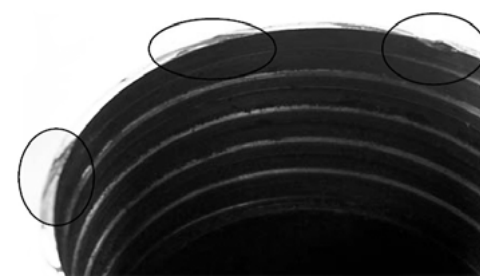

TROUBLESHOOTING

FATIGUE FAILURES OR CRACKED PINS OR BOXES

Potential Causes and Corrective Actions

1. Bend stresses have exceeded the fatigue strength of the joint. Bend stresses are caused by excessive steering, excessive hole deviations, caves, or helical whirling. Do not exceed deviation ratings. This may have been compounded by high pullback loads at depth or excessive make-up. Plan deviations to occur at portions of the string that are under low pullback (e.g. avoid the upper portion of a deep hole string). Fatigue strength may have been exceeded in previous application and joint cumulative fatigue damage has reached limit. Consider upgrading to XQ™ joints for higher load capacity or consider lightweight rods for reduced stiffness.
2. Rods run in loose (joints not closed) due to insufficient make-up or to excessive stand-off gap. Machining marks may still be visible on box shoulder.
3. Extraneous hoop stresses caused by deformation due to hammering damage, stabbing damage, excessive foreign debris, or wear debris in the joint.
4. Box shoulder deformed due to overload leaving pin or box unsupported. Overload may be due to poor choice of thread compound. Consider upgrading to XQ™ rods.
5. Top drive adapter sub pin shoulder and thread deformed leading to cracked boxes. Replace sub and inspect rod for water leakage and box cracks.
6. Rod string has suffered stress corrosion cracking, or hydrogen embrittlement. Replace suspect rods, correct excessive hole deviations, and address corrosive agents in drilling fluid.
7. Rods are of different manufacture. Separate all rods by manufacturer and do not interchange. RQ™ style joints are Boart Longyear's exacting design and fit of wireline rod joints is help proprietary. Also, patented XQ™ rods are only offered by Boart Longyear. ⚠



PIN FATIGUE



BOX FATIGUE

TROUBLESHOOTING

PREMATURE BOX END CRACKING/HEAT-CHECKING CRACKING

Potential Causes and Corrective Actions

1. Axial cracks at the box end due to a hardened, brittle surface layer formed while drilling. This thin surface layer is caused by the cyclic friction. Change in microstructure is caused by the cyclic friction between the rotating string and the case or hole wall and is independent of tubing type, steel grade and/or applied heat treatments. Often associated with a bright, polished area and thin cross-section on the box end. Reduce drilling loads and/or pullback, or improve lubrication of the string to compensate. Inspect box end with the shoulder wear gauge and cull out worn rods before heat-check cracking occurs. If helical polishing present along rod, take steps to reduce twisting like adjusting RPM (see rod twisting).
2. Stress corrosion either by itself or combined with heat-check cracking can fail rods early in life. Corrosion can be caused by fluid pH (acidic or basic), salt content (brine), high temperature, chlorine, fluorine or sulfides. Contact chemical/mud supplier to manage corrosive conditions.

Learn more about Heat-Check Cracking at:

<https://www.boartlongyear.com/insite/understanding-and-preventing-heat-check-cracking-on-drill-rods/>

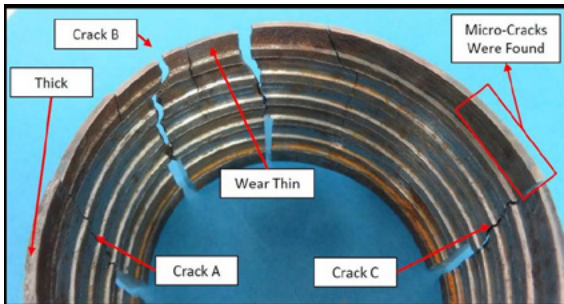

HEAT CHECK CRACKING - WORN THIN

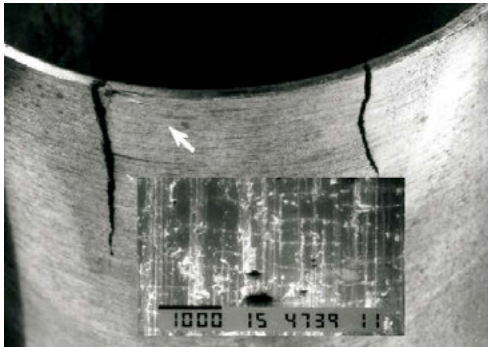

HEAT CHECK CRACKING

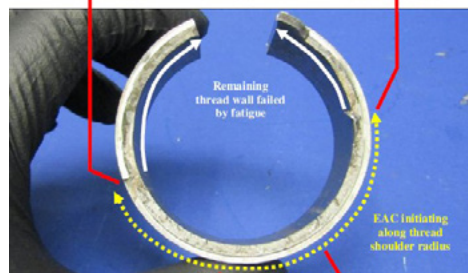

STRESS CORROSION

TROUBLESHOOTING

THREAD WEAR OR GALLING

Thread galling is where material has adhered to the mating surface and pulled away. This is a function of the material, the hardness and the same material creates the worst condition for galling. To help prevent galling and wear Boart Longyear case hardens all of its rod pins, making them much harder than the box threads.

Potential Causes and Corrective Actions

1. Thread compound has failed to prevent mating thread surfaces from interacting. This is due to either a poor or diluted compound or poor lubrication practice. Upgrade thread compound or increase frequency of cleaning and re-lubing joints.
2. Thread contact pressure during make or break is excessive. To address thread stab flank wear, reduce feed rate/pressure and/or increase rotation during make and break. To address thread load flank wear, increase feed rate and/or reduce rotation during make and break. Rods with significant load flank wear should be discarded.
3. Thread sliding contact is excessive (e.g. too much drag during make/break turns) or frequent jamming or cross-threading. Consider upgrading to XQ™ style joints.
4. Accelerated wear may be due to damaged accessories; inspect accessories for damage or wear (e.g. adapter subs).
5. Thread wear life exceeded. Accelerated wear may be due to damaged accessories; inspect accessories (e.g. adapter subs). Inspect string for excessive wear.
6. Consider upgrading to XQ™ rods. XQ™ joints have double-start threads with patented self-starting, self-aligning geometry for easy, automatic make-up. XQ™ joints balance loads and wear across the joint for maximum wear life and load strength. XQ™ threads typically last for 2x RQ™ and 3x Q™ thread make and breaks.



BOX THREAD GALLING



PIN THREAD GALLING

TROUBLESHOOTING

BOX WEAR OR BOX BULGING OR THREAD JUMPING

Potential Causes and Corrective Actions

1. Box bulging due to excessive hoop stresses imposed by thread, potentially from overload. Evident by polished areas on one side of box or thread jumping in the extreme case. Overload may be caused by poor choice of thread compound. Consider upgrading to XQ™ rods.
2. Box wear life exceeded leading to overload. Inspect string for excessive wear. Consider upgrading to XQ™ rods. XQ™ joints have less bulging and do not jump threads with overload as is possible with conventional thread forms.
3. Consider upgrading to XQ™. XQ™ joints have less bulging and do not jump threads with overload as is possible with conventional thread forms.

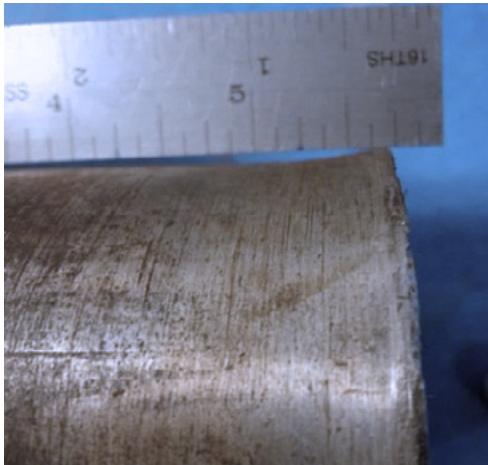

OVERLOAD



OVERLOAD

TROUBLESHOOTING

EXTERNAL SHOULDER WEAR OR EXTERNAL SHOULDER FLARED/ROLLED OVER

Potential Causes and Corrective Actions

1. Box shoulder flared and/or pin outer shoulder rolled over due to overload. Overload may be due to poor choice of thread compound. Consider upgrading to XQ™ joints.
2. Box shoulder wear life exceeded. Inspect string for excessive wear. Consider upgrading to XQ rods.



PIN SHOULDER AND PIN END FLARED DUE TO OVERLOAD

MID-BODY WEAR

Potential Causes and Corrective Actions

1. Hole deviations (e.g. rotary drilled holes, wedging, or down-hole monitoring) induce increased contact pressure and friction between string and hole or casing wall. Improve lubrication of string to compensate.
2. Hole has oversized or 'cave' sections allowing the string to elastically twist or buckle under load increasing contact pressure and friction. Reduce drilling loads or rotation speed to compensate or repair hole.
3. High pullback or thrust load combined with high rotation speed has caused the string to elastically or permanently twist, increasing contact pressure and friction against the hole or casing wall. Evident by polished or heavy wear on one side of string in a slow spiral pattern (e.g. spiral has a multiple length pitch). Reduce drilling loads and/or pullback.



MID-BODY WEAR

MID-BODY FATIGUE FAILURES

Potential Causes and Corrective Actions

1. Accumulated surface damage from rod handling with excessive gripping pressure, combined with cyclic loading leads to fatigue cracking. Care should be taken when handling rods to prevent damage. Rods with gripper tooth damage deeper than 1/32" or 0.8 mm should be retired.
2. Loads are highest on devices with a single pair of opposed actuators. If a characteristic T shaped crack occurs, check rod handlers, foot clamps and chucks for excess clamping pressure.



FATIGUE



FATIGUE



FATIGUE - T SHAPE DUE TO EXCESS CLAMP LOAD



FATIGUE - SPIRAL DUE TO TORQUE

TROUBLESHOOTING

ROD TWISTING (AKA BENDING) OR HIGH TORQUE AND VIBRATION

The drill string has permanently bent or twisted into a spiral shape, increasing contact pressure and friction against the hole or casing wall. Evident by increased vibration and torque in the hole. Rods show polishing or heavy wear on one side of string in a slow spiral pattern (e.g. spiral pattern completes a full revolution over typically four rod lengths).

The following factors can contribute to rod twisting:

- Higher RPM increase likelihood to twist, reduce speed to reduce energy.
- A lack of lubrication since fluid dampens vibration and reduces friction to prevent twisting. Grout hole to recover circulation and/or grease rods.
- Increasing hole angle increases friction in the hole.
- Larger Annulus, larger size casing or oversize bits create more space for rods to twist.
- Dog leg severity or rapid change in direction. Even 10 degrees in 20 m approaches rod strength limit. Stay within deviation guidelines and place cuts towards bottom of hole if possible.
- Rod twisting is a resonance or dynamic event, so minimizing vibration by adjusting speed up or down by as little as 50 RPM can reduce the chance of rod twisting. Note vibration level and change speed to minimize vibration by avoiding natural frequency.



WARNING

If using a kelly rod, start rotation slowly. Any bend or twist in the rod will be observed as wobble. If rod wobbles or rotates unevenly, stop, chuck lower on rod and if necessary replace kelly rod. Drilling at full speed with wobbling rod will lead to catastrophic bending, rod failure and potential injury.



TWISTED RODS

GLOSSARY

Adhesion Wear

This type of wear involves the adhesion (micro-bonding or micro-welding) of very small areas between the contacting surfaces of mating threads with similar hardness. The bonded areas can fracture off, generating wear particles, or transfer to the mating surface. Wear particles can then bond together and grow in size, producing larger scale wear. In the extreme case, adhesion wear can seize a joint. The rate of adhesion wear decreases as the surface hardness and hardness difference between contacting surfaces increases. Adhesion wear will not occur if the thread compound prevents contact of the surfaces.

Abrasion Wear

This type of wear involves gouging and polishing of a surface by wear particles or foreign debris. Wear particles are either repelled or embedded into the subject surface but do not build or micro-weld avoiding joint seizure. The rate of abrasion wear is directly proportional to the contact pressure and the sliding distance between the mating surfaces. The rate of abrasion wear decreases as the surface hardness increases. Also, the rate of wear is less between mating thread surfaces of differing hardness. Abrasion wear will not occur if the thread compound prevents contact of the surfaces.

Dog Leg

A dog leg refers to the total deviation along a length of the hole that includes both the change in azimuth or direction, and inclination or dip. Excessive deviations produce high lateral loads and fatigue loads which can result in fatigue failure, heat-check cracking, or twisting rod mid-bodies. Furthermore, multiple oblique or corrective dog legs increase these loads. It is recommended that deviations are limited (less than one degree per rod length) and oblique dog legs eliminated. Calculate Dog leg as follows: Dog leg angle = $\cos^{-1} [\cos(\text{azimuth change}) \sin(\text{final dip}) \sin(\text{initial dip}) + \cos(\text{final dip}) \cos(\text{initial dip})]$

Fatigue

Fatigue damage is cumulative. All steels have a limit to the number of applications or reversals of an excessive repeating load which is commonly referred to as memory. For example, a rod may successfully complete one demanding application and then fail in a future, less demanding application when the limit is finally exceeded with only a few more cycles of excessive load. The generally accepted limit for steels to an excessive repeating or alternating load is three million cycles. At 500 RPM, this is 100 hours of drilling which could easily traverse more than one job where the excessive loading is not continuous (larger sizes are more prone to fatigue failures as they have inherently higher twisting stresses). Fatigue failures can be caused by an excessive load that fluctuates due to rotation (e.g. a twisting load, a hoop stress due to large foreign debris particles, stabbing damage, etc).

Fretting

Small relative cyclic movement between two surfaces in contact. Fretting produces pitting wear (a form of adhesion wear) which can lead to fatigue failures. The wear rate increases with amplitude but not with frequency.

Galling

Large scale (visual) damage to both mating thread surfaces in a joint caused by small areas of plastic deformation (adhesions or transfers, see adhesion wear) that interfere with sliding which can lead to seizure. Galling resistance is a function of the mating surfaces, not of a single surface, and is typically not seen on Boart Longyear™ drill rods.

GLOSSARY

Heat Check Cracking

This is axial cracking (crack works from the outside surface in) resulting from the rapid expansion of a thin layer of brittle surface material that was hardened by the heat of friction (e.g. rods rubbing on casing or hold) and then rapidly quenched by drilling fluid and the cooler material underneath. Axial cracks typically form on box ends that bulge, due to drilling loads, and suffer accelerated abrasion wear. It is recommended to inspect rod strings for visibly polished box ends as this indicates excessive torque and lateral loading due to hole deviations or similar application extremes.

Inertia

The force developed by the momentum of a moving or rotating mass (such as rotating rod string or a drill head) which resists acceleration or deceleration.

Inertial Torque

Inertial torque is make-up induced when the joint of an added rod is fully made up and stops abruptly against the inertia of the rotating drill head.

Joint Load Efficiency

This is a measure of how much load a joint can carry, as compared to the mid-body. Inversely, this is a measure of how much more stress is created in the joint by a load, as compared to the mid-body. Consider that about half of the rod tubing wall thickness or section is removed when cutting a threaded joint, which means a loss of half the strength. Also, all traditional threads create additional stress (less strength) due to poor choice of geometry. For example, the Q™ joints are 30% load efficient which means there is only a third of the load capacity of the full section of tube, or 3x the stress than that created in a full section of tube. The HD threads have a better choice of geometry improving load efficiency to 40%, producing only 2.5x the stress under load. Ultimately, the engineered RQ™ and XQ™ joints actually mimic the load response of a solid tube and provide 50% load efficiency which is half the strength of a solid tube, or only 2x the stress under load.

Joint Seizure

Mating thread surfaces are not able to move relative to each other as a result of increased friction due to galling or adhesion wear (local solid-state welding, 'micro-welding') potentially preventing break-out of a joint. Typically not seen on Boart Longyear joints with differing mating surface hardness.

Spin Outs

Sudden break-out of joints due to the inertia of a rotating rod string under deceleration.

Stress

Stress is the material response to a load. Stress causes steel to deform elastically (strain) up to the yield strength, beyond which deformation is permanent. In a drill rod, there are three components or directions of stress:

- Axial Stress
- Hoop Stress
- Radial Stress

These components add together according to vector addition to a total stress value known as the principle or Von-Mises stress.

The axial stress is directed parallel to the rod longitudinal axis and is a direct result of drilling or twist loads.

The hoop stress is directed circumferentially around the tube and perpendicular to the rod axis. In a rod joint, hoop stress is induced by the thread form and adds to the total stress - except to RQ™ and XQ™ style joints which reduce the total stress - mimicking the mid-body.

The radial stress is directed radially inwards or outwards from the rod longitudinal axis and is typically not significant, except under extraordinarily high fluid pressures.

Stress Corrosion & Hydrogen Embrittlement

Given a stress level due to normal drilling loads, corrosive agents in the drilling fluid will chemically reduce material resistance to crack propagation dramatically. Underground operations exposed to mine water are often subject to stress corrosion in addition to generally accelerated corrosion. Stress Corrosion processes often involve hydrogen. Hydrogen has damaging effects on all metals, including reduction of fatigue strength, enhancement of crack propagation and corrosion cracking. Hydrogen may be encountered in the hole, or may be created by reactions with acidic fluids in the hole or generated by corrosion. The absorption of hydrogen in metals is enhanced by sulphide-bearing waters (H₂S) and by drilling fluid acidity. Regular monitoring of drilling fluid pH levels is recommended.



100% HANDS-FREE ROD HANDLING

LF™160 SURFACE CORING DRILL RIG

Achieve more productivity while enhancing safety with Boart Longyear's LF™160 surface coring drill rig and Freedom™ Loader combination. The loader's hands-free rod handling and remote controls offer more control and oversight which means less interruption and a safer, more efficient operation.



STRONGER, LASTS LONGER, EASIER MAKE AND BREAK

XQ™ wireline coring rods provide the ultimate performance and longevity, featuring innovative self-aligning, double-start threads, enabling automated make and break without wedging or jamming.



MORE CORE IN THE BOX

Longyear™ Diamond Bits include a chemical bond between diamond and matrix, which acts stronger than the diamond itself. The increased diamond projection and improved face flushing create a bit with more versatility, higher penetration rates, and longer life.



WARRANTY

WARRANTY

LIMITED WARRANTY.

(a) Consumables. Boart Longyear warrants for a period of one (1) year after the date of shipment of the consumable products manufactured by it, or the performance of related services, under the Contract, that such consumable products are free from defects in materials and workmanship and such services are performed in a professional and workmanlike manner; provided, however, with respect to consumable products purchased through an authorized Boart Longyear distributor, the warranty period shall commence on the date of purchase by the end user.

(b) Capital Equipment. Boart Longyear warrants that the capital equipment manufactured by it is free from defects in materials and workmanship for a period equal to the lesser of (i) one (1) year after the date of shipment, or (ii) the initial 1,000 operating hours. Boart Longyear warrants for a period of six (6) months after the performance of related services that such services are performed in a professional and workmanlike manner.

(c) General Terms. Boart Longyear further warrants that, to the extent applicable, as of the date of shipment or performance, all goods manufactured by it and services performed shall conform to the written specifications agreed between the parties.

THIS IS BOART LONGYEAR'S ONLY WARRANTY. BOART LONGYEAR MAKES NO OTHER WARRANTY, INCLUDING WITHOUT LIMITATION, ANY WARRANTY OF MERCHANTABILITY OR FITNESS FOR A PARTICULAR PURPOSE.

As a condition to Boart Longyear's warranty obligations, Purchaser must: (i) contact Boart Longyear and request authorization to return any goods claimed to be defective promptly upon Purchaser's discovery of the alleged defect, (ii) upon receipt of an approved authorized code from Boart Longyear, return any goods claimed to be defective under the foregoing warranty, at Purchaser's expense, to the facility designated by Boart Longyear, and (iii) with respect to consumable products purchased through an authorized Boart Longyear distributor, the party making the warranty claim must also deliver to Boart Longyear reasonable evidence of the date of purchase. Boart Longyear shall perform its examination of the goods so returned by

Purchaser and shall report the results of its examination to Purchaser within thirty (30) days following its receipt of such goods from Purchaser, or, if longer time is required to complete such examination, within such time as would be required through the exercise of reasonable diligence. As further condition to Boart Longyear's obligations hereunder for breach of warranty, Purchaser shall offer its reasonable cooperation and assist Boart Longyear in the course of Boart Longyear's review of any warranty claim. If requested by Purchaser, Boart Longyear will promptly repair or replace, at Boart Longyear's expense, goods that are confirmed to be non-conforming as a result of Boart Longyear's examination and according to Boart Longyear's warranty as set forth herein. All removal and installation of goods shall be at Purchaser's expense; provided, however, Boart Longyear will reimburse the Customer for an amount equal to the reasonable expenses incurred by the Customer and attributable to the removal and shipment of any defective goods. Boart Longyear reserves the right to reimburse Purchaser for an amount equal to the purchase price of any defective goods in lieu of providing repaired or replacement goods. Anything contained herein to the contrary notwithstanding, in no event shall Boart Longyear be liable for breach of warranty or otherwise in any manner whatsoever for: (i) normal wear and tear; (ii) corrosion, abrasion or erosion; (iii) any goods, components, parts, software or services which, following delivery or performance by Boart Longyear, has been subjected to accident, abuse, misapplication, modification, improper repair, alteration, improper installation or maintenance, neglect, or excessive operating conditions; (iv) defects resulting from Purchaser's specifications or designs or those of its contractors or subcontractors other than Boart Longyear; (v) defects associated with consumable parts or materials, the lifetime of which is shorter than the warranty period set for in this Section; (vi) defects associated with Purchaser's specifications or designs or those of its contractors or subcontractors other than Boart Longyear; (vii) defects resulting from the manufacture, distribution, promotion or sale of Purchaser's own products; or (viii) accessories of any kind used by the Purchaser which are not manufactured by or approved by Boart Longyear.

WARRANTY

(d) Sourced Goods. If the defective parts or components are not manufactured by Boart Longyear, the guarantee of the manufacturer of those defective parts or components is accepted by the Purchaser and is the only guarantee given to the Purchaser in respect of the defective parts or components. Boart Longyear agrees to assign to the Purchaser on request made by the Purchaser the benefit of any warranty or entitlement to the defective parts or components that the manufacturer has granted to Boart Longyear under any contract or by implication or operation of law to the extent that the benefit of any warranty of entitlement is assignable.

(e) Limitation on Liability. Except as provided for herein, in no event will Boart Longyear be liable for any indirect, incidental, special, consequential, punitive or similar damages include, but not limited to, lost profits, loss of data or business interruption losses. In no event will the total, aggregate liability is claimed. The liability limitations shall apply even if Boart Longyear has been notified of the possibility or likelihood of such damages occurring and regardless of the form of action, whether in contract, negligence, strict liability, tort, products liability or otherwise. The parties agree that these limits of liability shall survive and continue in full force and effect despite any termination or expiration of any Contract. Any action by Purchaser against Boart Longyear must be commenced within one year after the cause of action has accrued. No employee or agent of Boart Longyear is authorized to make any warranty other than that which is specifically set forth herein. The provisions in any specification, brochure or chart issued by Boart Longyear are descriptive only and are not warranties.



AFTERMARKET SPARES AND SERVICES

One of Boart Longyear's leading advantages is its aftermarket spares and services. Not only do we offer the most innovative products in the industry, but we also offer the best aftermarket spares and services. Our customers benefit from the ability to quickly and efficiently receive the spares that delay projects.

Untrained drillers and mechanics can be a significant expense to our clients. This is why we've developed aftermarket services that offer hands-on training for drillers and in-house and on-site repairs and services. By increasing the knowledge of our client's drillers and properly maintaining their equipment, we are able to reduce costs, keep fleets drilling longer and ultimately increase productivity.



Global Headquarters

Boart Longyear
2455 South 3600 West
Salt Lake City, UT 84119
United States of America
info@boartlongyear.com

Tel: +1 801 972 6430
Fax: +1 801 977 3374

Canada

Boart Longyear
2442 South Sheridan Way
Mississauga, Ontario
Canada L5J 2M7
info@boartlongyear.com

Tel: +1 905 822-7922
Fax: +1 905 822-7232

Asia Pacific

Boart Longyear
26 Butler Boulevard
Adelaide, 5950
Australia
info_au@boartlongyear.com

Tel: +61 8 8375 8375
Fax: +61 8 8375 8497

Latin America

Boart Longyear
Av. Los Libertadores 16.500 - Sitio 1-A-2
Complejo Industrial Los Libertadores
Colina, Santiago-Chile
infochile@boartlongyear.com

Tel: +56 2 595 3300
Fax: +51 242 671

Europe

Boart Longyear
12 Avenue des Morgines
CH1213 Petit-Lancy,
Geneva, Switzerland
infoEU@boartlongyear.com

Tel: +41 22 709 0800
Fax: +41 22 709 0801

Russia

Boart Longyear
1 Timiryazevskaya street, 3d floor
Business Center Premier
Moscow, Russia, 127422
infosar@boartlongyear.com

Tel: +7 495 786 9710
Fax: +7 495 784 6372

PERFORMANCE PRODUCTS

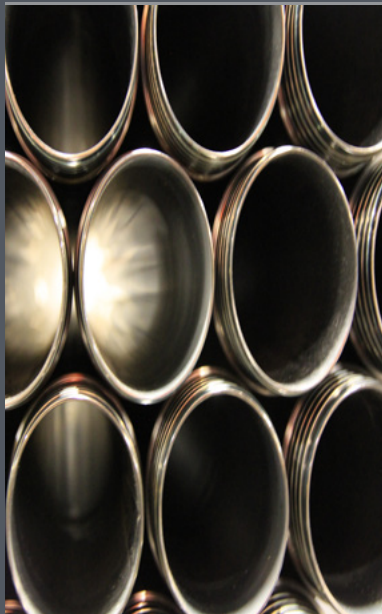

XQ™



Roller Latch™



Longyear™ Diamond Bits

<https://www.boartlongyear.com/product/xq-wireline-coring-rod/>