

**MITSUBISHI**

**GK16E**

ADVANCED MULTI-PURPOSE SYSTEM FOR CASING ADVANCEMENT

# ***ULTRA MAXBIT***

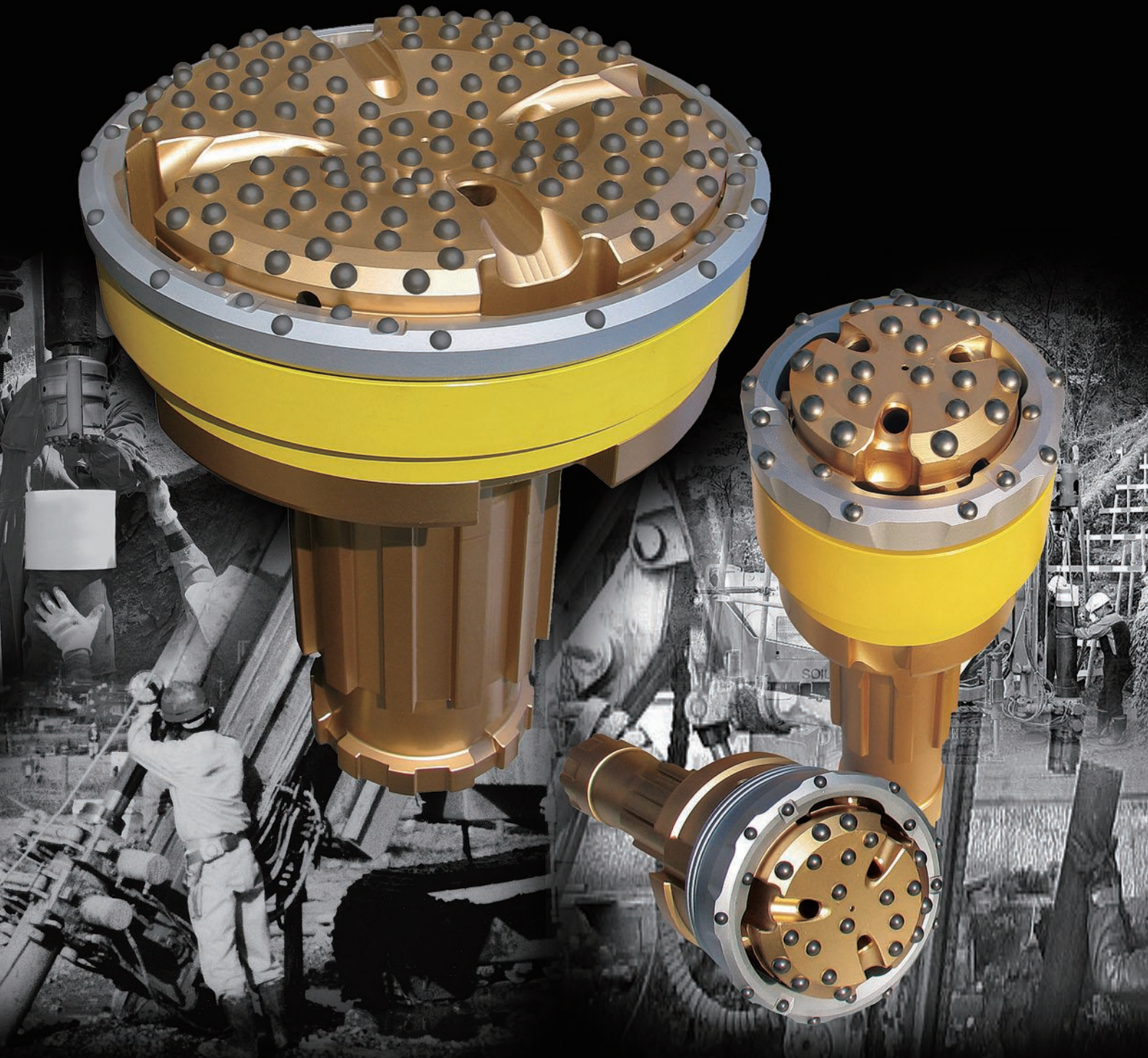

**MITSUBISHI MATERIALS**

# ULTRA MAXBIT

ADVANCED MULTI-PURPOSE SYSTEM FOR CASING ADVANCEMENT

## STRUCTURE AND FEATURE

### ● High speed and straight drilling in wide range of ground conditions

- ULTRA MAXBIT is used for simultaneous drilling and casing in unstable soft ground formations.
- ULTRA MAXBIT is also applicable for wide range of ground conditions such as sand, gravel and boulders and rock.
- The dual bit system also allows vertical, horizontal, and even inclined drilling.

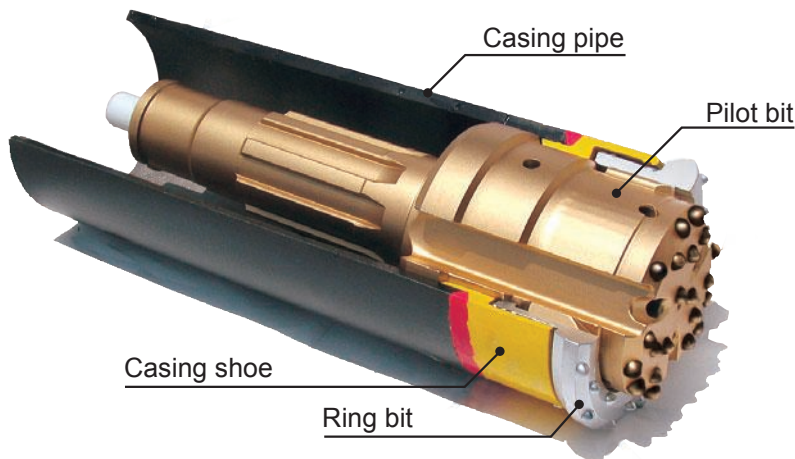

### ● Easy lock system

- Easy and speedy set-up.

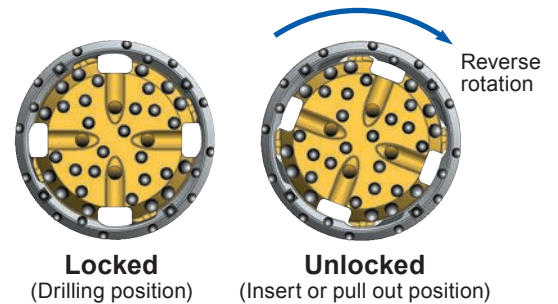

### ● Pilot bit

(Standard-connected to DTH Hammer)

- Pilot Bit is manufactured in three models, Single, Normal and Multi pass models.
- Twin impact shoulders.



(Big Bore-connected to DTH Hammer)

- Big bore type is available.
- This new and improved model offers additional strength when drilling larger bore holes.
- Single impact shoulder.

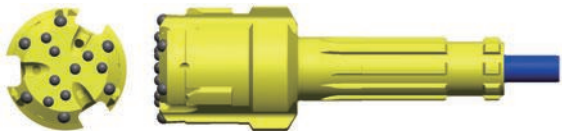

(Top hammer-connected to threaded rod)

- Top hammer type with R32, T38, T45, T51 thread is available.
- Twin impact shoulders.



### ● Stiff connecting structure between ring bit and casing shoe

(Thread connection type)

- Single pass model
- Normal model
- Top hammer model

\* Easy to assemble or disassemble at Job-site.



(Interlinked type)

- Multi use model
- Big bore model

\* Assembled in the factory cannot be disassembled.

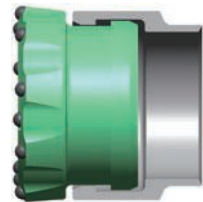





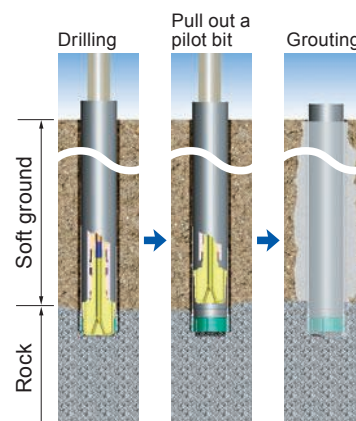

### ● Working types example

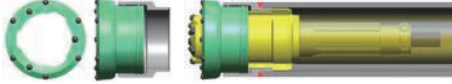
Fig.1 Piling construction (Permanent casing)

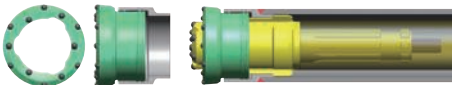

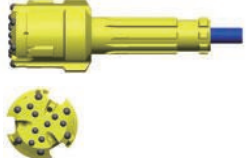
# OVERVIEW MAP

	Model	Pilot Bit	Casing Type	Casing Outer $\varnothing$ mm (in.)	Application & Pile Type Example
Standard-DTH System	<b>Single Pass Model</b> <ul style="list-style-type: none"> <li>Suitable for relatively soft ground and short hole depth.</li> <li>Leaving a casing pipe in the ground.</li> <li>Thread connection ring set.</li> </ul> 	<b>For DTH Hammer</b>  <ul style="list-style-type: none"> <li>Pilot Bit is manufactured in Single, Normal and Multi pass model as long as casing size is same.</li> </ul>	Permanent	89.1–1016 (3 1/2"–40")	<ul style="list-style-type: none"> <li>Piling construction ...Fig.1</li> </ul>
	<b>Normal Model</b> <ul style="list-style-type: none"> <li>Suitable for heavy duty single pass and longer hole depth.</li> <li>Leaving a casing pipe in the ground.</li> <li>Thread connection ring set.</li> </ul> 		Permanent or *1 Retrievable	114.3–457.2 (4 1/2"–8")	<ul style="list-style-type: none"> <li>Piling construction ...Fig.1</li> <li>Water well ...Fig.2</li> <li>Geothermal ...Fig.2</li> </ul>
	<b>Multi Use Model</b> <ul style="list-style-type: none"> <li>Pulling force to remove casing is reduced.</li> <li>This enables the casing pipe to be re-used.</li> <li>Interlinked ring set.</li> </ul> 		Retrievable	89.1–1016 (3 1/2"–40")	<ul style="list-style-type: none"> <li>Anchor construction ...Fig.3</li> <li>Foundation construction ...Fig.3</li> </ul>
Big Bore-DTH System	<b>Big Bore Model</b> <ul style="list-style-type: none"> <li>Suitable for large bore drilling.</li> <li>Interlinked ring set.</li> </ul> 	<b>For DTH Hammer</b> 	Permanent	114.3–355.6 (4 1/2"–14")	<ul style="list-style-type: none"> <li>Foundation construction ...Fig.1</li> <li>RD Pile *2 ...Fig.1</li> <li>Water well ...Fig.2</li> <li>Geothermal ...Fig.2</li> </ul>
Top Hammer System	<b>Top Hammer Model</b> <ul style="list-style-type: none"> <li>Suitable for small hole tunneling.</li> <li>Thread connection ring set.</li> </ul> 	<b>For Top Hammer</b> 	Permanent	76.3–139.7 (3"–5 1/2")	<ul style="list-style-type: none"> <li>Pipe roof ...Fig.4</li> <li>Piling construction ...Fig.4</li> </ul>

\*1 Limited to shallow hole drilling only.  
\*2 Refer to page 19.

**Fig.2** Water well and Geothermal

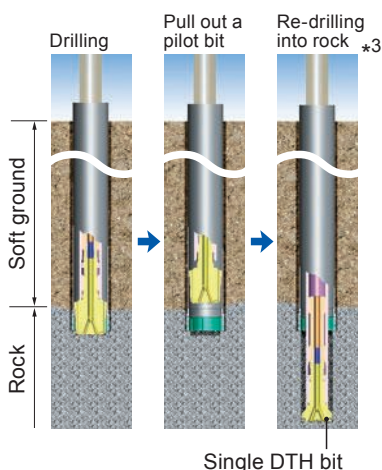

**Fig.3** Foundation construction (Temporary casing)

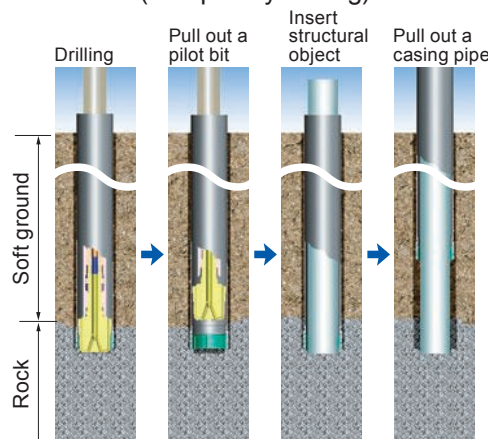

**Fig.4** Tunneling (Permanent casing)

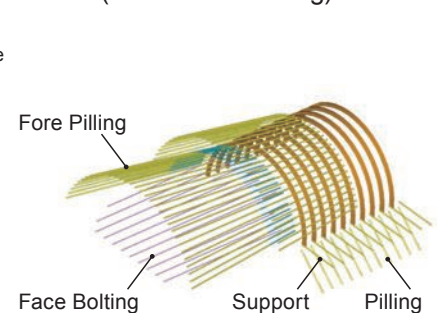

\*3 If hard ground is encountered, the ULTRA MAXBIT can be removed and drilling can be switched to a small diameter DTH BIT.

# DIMENSIONS

## Standard Type ULTRA MAXBIT / DTH

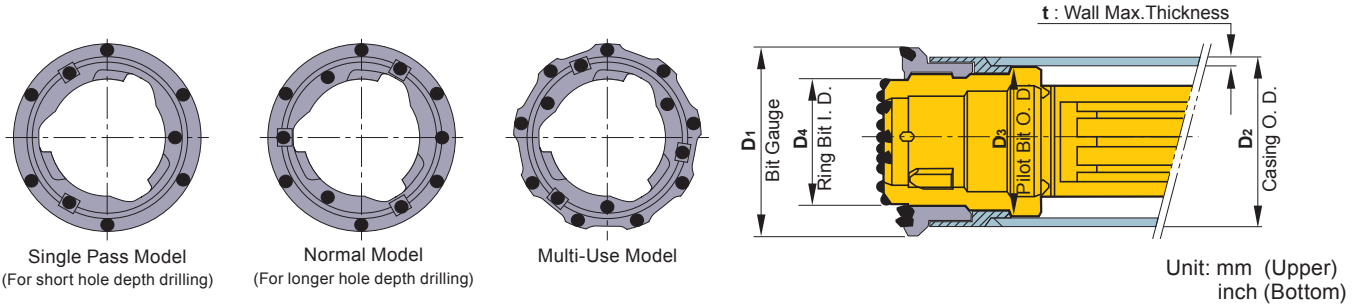

Casing Pipe		Type	Ring Bit			Pilot Bit			Ring Set (Ring Bit & Casing Shoe)	Compatible Part	System Part Number
Outer Dia. D <sub>2</sub>	Wall Max. Thickness t		Model	Inner Dia. D <sub>4</sub>	Outer Dia. D <sub>1</sub>	Outer Dia. D <sub>3</sub>	Hammer	Weight (kg)			
<b>CASING PIPE ø89.1mm (3 1/2")</b>											
89.1 (3 1/2")	6.3 (0.25")	056D	Single pass	56 2.20"	100 3.94"	74 2.91"	DHD065	5.0	2.7	US056D-02-R-266	
	7.0 (0.28")	059W	Multi use	59 2.32"	99 3.90"	73 2.87"	DHD065	5.0	2.4	UM059W-02-R-240	
<b>CASING PIPE ø114.3mm (4 1/2")</b>											
114.3 (4 1/2")	10.0 (0.39")	072A	Single pass	72 2.83"	126 4.96"	92 3.62"	DHD3.5 COP34 COP32	8.5 9.1 8.5	4.7	US072A-03-BB-004 US072A-03-R-035	
				72 2.83"	126 4.96"	92 3.62"	DHD3.5 COP34 COP32	8.5 9.1 8.5			
			Normal	72 2.83"	126 4.96"	92 3.62"	DHD3.5 COP34 COP32	8.5 9.1 8.5			4.7
		72 2.83"		122 4.80"	92 3.62"	DHD3.5 COP34 COP32	8.5 9.1 8.5				
		072W	Multi use	72 2.83"	122 4.80"	92 3.62"	DHD3.5 COP34 COP32	8.5 9.1 8.5	4.4	072A Pilot bit	UM072W-03-R-285
				72 2.83"	126 4.96"	95.5 3.76"	DHD3.5 COP34 COP32	8.7 9.3 8.7			
	8.0 (0.31")	072B	Single pass	72 2.83"	126 4.96"	95.5 3.76"	DHD3.5 COP34 COP32	8.7 9.3 8.7	4.8	US072B-03-R-090	
				72 2.83"	126 4.96"	95.5 3.76"	DHD3.5 COP34 COP32	8.7 9.3 8.7			
		072X	Multi use	72 2.83"	122 4.80"	95.5 3.76"	DHD3.5 COP34 COP32	8.7 9.3 8.7	4.6	072B Pilot bit	UM072X-03-R-369
	78 3.07"			124 4.88"	98 3.86"	DHD3.5 COP34 COP32	9.5 10.1 9.5				
	6.5 (0.26")	078W	Multi use	78 3.07"	124 4.88"	98 3.86"	DHD3.5 COP34 COP32	9.5 10.1 9.5	3.9	UM078W-03-R-239	
	6.35 (0.25")	080A	Single pass	80 3.15"	124 4.88"	99.5 3.92"	DHD3.5 COP34 COP32	9.7 10.3 9.7	3.9	US080A-03-R-341	
				80 3.15"	124 4.88"	99.5 3.92"	DHD3.5 COP34 COP32	9.7 10.3 9.7			
			Normal	80 3.15"	124 4.88"	99.5 3.92"	DHD3.5 COP34 COP32	9.7 10.3 9.7			4.0
		80 3.15"		128 5.04"	99.5 3.92"	DHD3.5 COP34 COP32	9.7 10.3 9.7				
		080W	Multi use	80 3.15"	128 5.04"	99.5 3.92"	DHD3.5 COP34 COP32	9.7 10.3 9.7	4.5	080A Pilot bit	UM080W-03-R-371
				82 3.23"	126 4.96"	100 3.94"	DHD3.5 COP34 COP32	10.1 10.7 10.1			
	6.0 (0.24")	082A	Single pass	82 3.23"	126 4.96"	100 3.94"	DHD3.5 COP34 COP32	10.1 10.7 10.1	3.8	US082A-03-R-372	
				82 3.23"	126 4.96"	100 3.94"	DHD3.5 COP34 COP32	10.1 10.7 10.1			
			Normal	82 3.23"	126 4.96"	100 3.94"	DHD3.5 COP34 COP32	10.1 10.7 10.1			3.9
		82 3.23"		128 5.04"	100 3.94"	DHD3.5 COP34 COP32	10.1 10.7 10.1				
		082W	Multi use	82 3.23"	128 5.04"	100 3.94"	DHD3.5 COP34 COP32	10.1 10.7 10.1	4.5	082A Pilot bit	UM082W-03-R-342
				82 3.23"	128 5.04"	100 3.94"	DHD3.5 COP34 COP32	10.1 10.7 10.1			

Note 1) Normal model enables to be re-used in case of short hole drilling.

Note 2) To order, please advise the system type, casing size / hammer size and the ring bit models.

Note 3) Special types are also available according to customer's request.

# Standard Type ULTRA MAXBIT / DTH

## ● System Part Number

### U S 097A - 04 - R - 037

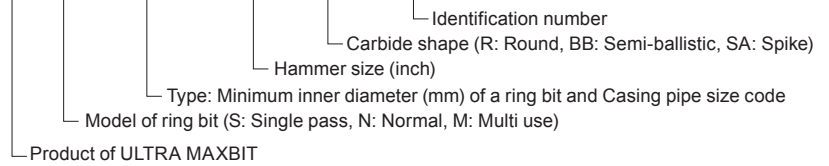

Unit: mm (Upper)  
inch (Bottom)

Casing Pipe		Type	Ring Bit			Pilot Bit			Ring Set (Ring Bit & Casing Shoe)	Compatible Part	System Part Number	
Outer Dia. D <sub>2</sub>	Wall Max. Thickness t		Model	Inner Dia. D <sub>4</sub>	Outer Dia. D <sub>1</sub>	Outer Dia. D <sub>3</sub>	Hammer	Weight (kg)				Weight (kg)
<b>CASING PIPE ø127.0mm (5")</b>												
127.0 (5")	10.0 (0.39")	082X	Multi use	82	135	105	DHD3.5	10.3	5.1		UM082X-03-R-374	
				3.23"	5.31"	4.13"	COP34	10.9				
	8.8 (0.35")	084A	Single pass	84	137	107	DHD3.5	10.6	5.4			US084A-03-R-103
				3.31"	5.39"	4.21"	COP34	11.2				
<b>CASING PIPE ø133.0mm (5 15/64")</b>												
133.0 (5 15/64")	10.0 (0.39")	090W	Multi use	90	141	110.5	DHD340	13.4	5.3		UM090W-04-R-217	
				3.54"	5.55"	4.35"	QL40	14.7				
							SD4	14.5				
<b>CASING PIPE ø139.7mm (5 1/2")</b>												
139.7 (5 1/2")	10.0 (0.39")	097A	Single pass	97	150	117.5	DHD340	14.7	5.7	097A Pilot bit	US097A-04-BB-001 US097A-04-R-037	
				3.82"	5.91"	4.63"	QL40	16.0				
		097A	Normal	97	150	117.5	DHD340	14.7	5.9			UN097A-04-BB-002 UN097A-04-R-080
				3.82"	5.91"	4.63"	QL40	16.0				
		097W	Multi use	97	147	117.5	DHD340	14.7	5.6			UM097W-04-R-286
				3.82"	5.79"	4.63"	QL40	16.0				
	097X	Multi use	97	147	117.5	DHD340	14.7	5.8	UM097X-04-R-480			
			3.82"	5.79"	4.63"	QL40	16.0					
	8.0 (0.31")	105A	Single pass	105	152	125	DHD340	18.0	4.9	105A Pilot bit	US105A-04-R-101	
				4.13"	5.98"	4.92"	QL40	19.3				
		105A	Normal	105	152	125	DHD340	18.0	5.0			UN105A-04-BB-025 UN105A-04-R-375
				4.13"	5.98"	4.92"	QL40	19.3				
105W		Multi use	105	150	125	DHD340	18.0	5.3	UM105W-04-R-498			
			4.13"	5.91"	4.92"	QL40	19.3					
					SD4	19.1						
<b>CASING PIPE ø152.4mm (6")</b>												
152.4 (6")	10.0 (0.39")	110A	Single pass	110	163	130	DHD340	20.0	6.6	110A Pilot bit	US110A-04-R-039	
				4.33"	6.42"	5.12"	QL40	21.3				
		110A	Normal	110	163	130	DHD340	20.0	6.7			UN110A-04-R-078
				4.33"	6.42"	5.12"	QL40	21.3				
		110W	Multi use	110	160	130	DHD340	20.0	6.7			UM110W-04-R-212
				4.33"	6.30"	5.12"	QL40	21.3				
					SD4	20.1						
<b>CASING PIPE ø165.2mm (6 1/2")</b> (→Next page)												
165.2 (6 1/2")	7.1 (0.28")	128C	Single pass	128	178	149	DHD350	30.0	6.4	128A Pilot bit 128A Ring bit	US128C-05-R-376	
				5.04"	7.01"	5.87"	QL50	29.5				
		128C	Normal	128	178	149	DHD350	30.0	6.5	128A Pilot bit 128A Ring bit		
				5.04"	7.01"	5.87"	QL50	29.5				
		128W	Multi use	128	180	149	DHD350	30.0	7.6	128A Pilot bit 128A Ring bit		
				5.04"	7.09"	5.87"	QL50	29.5				
					SD5	29.5						

To be continued

# DIMENSIONS

## Standard Type ULTRA MAXBIT / DTH

Unit: mm (Upper)  
inch (Bottom)

Casing Pipe		Type	Ring Bit			Pilot Bit			Ring Set (Ring Bit & Casing Shoe)	Compatible Part	System Part Number		
Outer Dia.	Wall Max. Thickness		Model	Inner Dia.	Outer Dia.	Outer Dia.	Hammer	Weight (kg)				Weight (kg)	
D <sub>2</sub>	t			D <sub>4</sub>	D <sub>1</sub>								D <sub>3</sub>
<b>CASING PIPE ø165.2mm (6 1/2")</b>													
165.2 (6 1/2")	6.0 (0.24")	128A	Single pass	128	178	149	DHD350	30.0	8.0		US128A-05-R-378		
				5.04"	7.01"	5.87"	QL50	29.5					
		SD5	29.5										
	128A	Normal	128	178	149	DHD350	30.0	6.5	UN128A-05-BB-026				
			5.04"	7.01"	5.87"	QL50	29.5						
			SD5	29.5									
5.0 (0.20")	128B	Normal	128	178	149	DHD350	30.0	6.5		128A Pilot bit 128A Ring bit	UN128B-05-R-256		
			5.04"	7.01"	5.87"	QL50	29.5						
			SD5	29.5									
<b>CASING PIPE ø168.3mm (6 5/8")</b>													
168.3 (6 5/8")	12.7 (0.50")	118A	Single pass	118	178	140	DHD350	25.5	8.9				US118A-05-R-041
				4.65"	7.01"	5.51"	QL50	25.0					
		SD5	25.0										
		118A	Normal	118	178	140	DHD350	25.5	9.0	UN118A-05-R-081			
				4.65"	7.01"	5.51"	QL50	25.0					
				SD5	25.0								
	118W	Multi use	118	175	140	DHD350	25.5	8.0	118A Pilot bit		UM118W-05-R-377		
			4.65"	6.89"	5.51"	QL50	25.0						
			SD5	25.0									
	10.0 (0.39")	126A	Single pass	126	178	146	DHD350	27.0		7.5			US126A-05-R-053
				4.96"	7.01"	5.75"	QL50	26.5					
		SD5	26.5										
		126A	Normal	126	178	146	DHD350	27.0	7.6	UN126A-05-R-058			
				4.96"	7.01"	5.75"	QL50	26.5					
				SD5	26.5								
	126W	Multi use	126	175	146	DHD350	27.0	7.1	126A Pilot bit		UM126W-05-R-379		
			4.96"	6.89"	5.75"	QL50	26.5						
			SD5	26.5									
8.0 (0.31")	126B	Single pass	126	178	146	DHD350	27.0	7.8		126A Pilot bit 126A Ring bit		US126B-05-R-380	
			4.96"	7.01"	5.75"	QL50	26.5						
	SD5	26.5											
	126B	Normal	126	178	146	DHD350	27.0	7.9	126A Pilot bit 126A Ring bit		UN126B-05-R-381		
			4.96"	7.01"	5.75"	QL50	26.5						
			SD5	26.5									
<b>CASING PIPE ø177.8mm (7")</b>													
177.8 (7")	12.7 (0.50")	127A	Single pass	127	188	149	DHD350	28.5		9.6			US127A-05-R-043
				5.00"	7.40"	5.87"	QL50	27.5					
		SD5	27.5										
		127A	Normal	127	188	149	DHD350	28.5	9.7	UN127A-05-R-079			
				5.00"	7.40"	5.87"	QL50	27.5					
				SD5	27.5								
	127W	Multi use	127	186	149	DHD350	28.5	9.1	127A Pilot bit		UM127W-05-R-287		
			5.00"	7.32"	5.87"	QL50	27.5						
			SD5	27.5									
	11.5 (0.45")	127C	Single pass	127	188	149	DHD350	28.5		9.7		127A Pilot bit 127A Ring bit	US127C-05-R-142
				5.00"	7.40"	5.87"	QL50	27.5					
	SD5	27.5											
10.0 (0.39")	127X	Multi use	127	186	149	DHD350	28.5	9.5	127A Pilot bit	UM127X-05-R-382			
			5.00"	7.32"	5.87"	QL50	27.5						
SD5	27.5												
4.8 (0.19")	142A	Normal	142	188	164.5	DHD360	38.5	7.1				UN142A-06-R-131	
			5.59"	7.40"	6.48"	QL60	38.0						
SD6	41.0												
<b>CASING PIPE ø190.7mm (7 1/2")</b>													
190.7 (7 1/2")	6.0 (0.24")	156A	Single pass	156	206	176.5	DHD360	42.0	7.5				US156A-06-R-155
				6.14"	8.11"	6.95"	QL60	41.5					
		SD6	44.5										
		156A	Normal	156	206	176.5	DHD360	42.0	7.6		UN156A-06-R-383		
	6.14"			8.11"	6.95"	QL60	41.5						
	SD6			44.5									
	5.3 (0.21")	156B	Single pass	156	206	176.5	DHD360	42.0	7.6	156A Pilot bit 156A Ring bit		US156B-06-R-384	
				6.14"	8.11"	6.95"	QL60	41.5					
		SD6	44.5										
		156B	Normal	156	206	176.5	DHD360	42.0	7.7		156A Pilot bit 156A Ring bit		UN156B-06-R-385
6.14"				8.11"	6.95"	QL60	41.5						
SD6				44.5									

Note 1) Normal model enables to be re-used in case of short hole drilling.

Note 2) To order, please advise the system type, casing size / hammer size and the ring bit models.

Note 3) Special types are also available according to customer's request.

# Standard Type ULTRA MAXBIT / DTH

Unit: mm (Upper)  
inch (Bottom)

Casing Pipe		Type	Ring Bit			Pilot Bit			Ring Set (Ring Bit & Casing Shoe)	Compatible Part	System Part Number			
Outer Dia.	Wall Max. Thickness		Model	Inner Dia.	Outer Dia.	Outer Dia.	Hammer	Weight (kg)				Weight (kg)		
D <sub>2</sub>	t			D <sub>4</sub>	D <sub>1</sub>	D <sub>3</sub>								
<b>CASING PIPE ø193.7mm (7 5/8")</b>														
193.7 (7 5/8")	12.7 (0.50")	143A	Single pass	143	206	166	DHD360	38.0	10.5		US143A-06-R-045			
				5.63"	8.11"	6.54"	QL60	37.5						
		143A	Normal	143	206	166	DHD360	38.0				10.2		UN143A-06-R-386
				5.63"	8.11"	6.54"	QL60	37.5						
		143W	Multi use	143	202	166	DHD360	38.0				10.2	143A Pilot bit	UM143W-06-R-288
				5.63"	7.95"	6.54"	QL60	37.5						
	11.0 (0.43")	151A	Single pass	151	206	170	DHD360	40.0	9.1		US151A-06-BB-013 US151A-05-R-075			
				5.94"	8.11"	6.69"	QL60	39.5						
	151W	Multi use	151	202	170	DHD360	40.0	8.4	151A Pilot bit	UM151W-06-R-387				
			5.94"	7.95"	6.69"	QL60	39.5							
	6.0 (0.24")	157A	Single pass	157	209	180	DHD360	43.5	9.2		US157A-06-R-388			
				6.18"	8.23"	7.09"	QL60	43.0						
157A		Normal	157	209	180	DHD360	43.5	9.5		UN157A-06-R-088				
			6.18"	8.23"	7.09"	QL60	43.0							
<b>CASING PIPE ø216.3mm (8 33/64")</b>														
216.3 (8 33/64")	8.2 (0.32")	175A	Single pass	175	231	197.5	DHD360	51.5	10.2		US175A-06-R-389			
				6.89"	9.09"	7.78"	QL60	51.0						
	175A	Normal	175	231	197.5	DHD360	51.5	10.3	175C Ring bit	UN175A-06-R-390				
			6.89"	9.09"	7.78"	QL60	51.0							
	7.7 (0.30")	175B	Single pass	175	231	197.5	DHD360	51.5	10.2	175A Pilot bit 175A Ring bit	US175B-06-R-277			
				6.89"	9.09"	7.78"	QL60	51.0						
	7.0 (0.28")	175D	Normal	175	231	197.5	DHD360	51.5	10.5	175A Pilot bit 175C Ring bit	UN175D-06-R-391			
				6.89"	9.09"	7.78"	QL60	51.0						
	5.8 (0.23")	175C	Normal	175	231	197.5	DHD360	51.5	10.4	175A Pilot bit	UN175C-06-R-279			
				6.89"	9.09"	7.78"	QL60	51.0						
<b>CASING PIPE ø219.1mm (8 5/8")</b>														
219.1 (8 5/8")	12.7 (0.50")	170A	Single pass	170	231	191	DHD360	49.0	11.8		US170A-06-BB-016 US170A-06-R-047			
				6.69"	9.09"	7.52"	QL60	48.5						
		170A	Normal	170	231	191	DHD360	49.0	11.9		UN170A-06-R-392			
				6.69"	9.09"	7.52"	QL60	48.5						
		170W	Multi use	170	227	191	DHD360	49.0	11.9	170A Pilot bit	UM170W-06-R-289			
				6.69"	8.94"	7.52"	QL60	48.5						
	10.3 (0.41")	170B	Single pass	170	231	191	DHD360	49.0	11.9	170A Pilot bit 170A Ring bit	US170B-06-R-265			
				6.69"	9.09"	7.52"	QL60	48.5						
	10.0 (0.39")	170D	Single pass	170	231	191	DHD360	49.0	12.3	170A Pilot bit 170A Ring bit	US170D-06-R-393			
				6.69"	9.09"	7.52"	QL60	48.5						
	170X	Multi use	170	227	191	DHD360	49.0	12.3	170A Pilot bit	UM170X-06-R-394				
			6.69"	8.94"	7.52"	QL60	48.5							
	6.5 (0.26")	178A	Normal	178	234	201	DHD360	51.0	12.4		UN178A-06-R-395			
				7.01"	9.21"	7.91"	QL60	50.5						
	5.0 (0.20")	182A	Normal	182	234	207	DHD360	54.5	11.4		UN182A-06-R-354			
				7.17"	9.21"	8.15"	QL60	54.0						
	4.8 (0.19")	187A	Normal	187	234	207.5	DHD360	55.5	9.9		UN187A-06-R-332			
				7.36"	9.21"	8.17"	QL60	55.0						
187W		Multi use	187	234	207.5	DHD360	55.5	9.5	187A Pilot bit	UM187W-06-R-333				
			7.36"	9.21"	8.17"	QL60	55.0							

To be continued

# DIMENSIONS

## Standard Type ULTRA MAXBIT / DTH

Unit: mm (Upper)  
inch (Bottom)

Casing Pipe		Type	Ring Bit			Pilot Bit			Ring Set (Ring Bit & Casing Shoe)	Compatible Part	System Part Number		
Outer Dia.	Wall Max. Thickness		Model	Inner Dia.	Outer Dia.	Outer Dia.	Hammer	Weight (kg)				Weight (kg)	
D <sub>2</sub>	t			D <sub>4</sub>	D <sub>1</sub>	D <sub>3</sub>							
<b>CASING PIPE ø241.8mm (9 33/64")</b>													
241.8 (9 33/64")	8.0 (0.31")	200A	Single pass	200	257	223.5	DHD360	64.5	12.8		US200A-06-R-396		
				7.87"	10.12"	8.80"	QL60	64.0					
				200	257	223.5	SD6	67.0					
				7.87"	10.12"	8.80"	DHD380	76.5					
		200A	Normal	200	257	223.5	QL80	76.1		13.0		UN200A-06-R-397	
				7.87"	10.12"	8.80"	SD6	67.0					
				200	257	223.5	DHD380	76.5					
				7.87"	10.12"	8.80"	QL80	76.1					
	6.2 (0.24")	200W	Multi use	200	257	223.5	SD8	69.7	13.5	200A Pilot bit	UM200W-06-R-398		
				7.87"	10.12"	8.80"	DHD360	64.5					
				200	257	223.5	QL60	64.0					
				7.87"	10.12"	8.80"	SD6	67.0					
		200B	Normal	200	257	223.5	DHD380	76.5	13.3	200A Pilot bit	UN200B-06-R-400		
				7.87"	10.12"	8.80"	QL80	76.1					
				200	257	223.5	SD8	69.7					
				7.87"	10.12"	8.80"	DHD360	64.5					
244.0 (9 39/64")	10.0 (0.39")	194A	Single pass	194	257	221	DHD360	59.0	13.3		US194A-06-R-182		
				7.64"	10.12"	8.70"	QL60	58.5					
							SD6	61.5					
		<b>CASING PIPE ø244.5mm (9 5/8")</b>											
		244.5 (9 5/8")	13.8 (0.54")	190C	Single pass	190	257	214	DHD380	71.2	14.5		US190C-08-R-319
						7.48"	10.12"	8.43"	QL80	70.8			
						190	257	214	SD8	64.4			
						7.48"	10.12"	8.43"	DHD360	58.0			
				190C	Normal	190	257	214	QL60	57.5	14.6		UN190C-08-R-320
						7.48"	10.12"	8.43"	SD6	60.5			
						190	257	214	DHD380	71.2			
						7.48"	10.12"	8.43"	QL80	70.8			
				190W	Multi use	190	253	214	SD8	64.4	12.8	190C Pilot bit	UM190W-08-R-321
						7.48"	9.96"	8.43"	DHD380	58.0			
						190	253	214	QL80	57.5			
7.48"	9.96"					8.43"	SD8	60.5					
12.7 (0.50")	190D		Single pass	190	257	214	DHD380	71.2	14.8	190C Pilot bit	US190D-08-R-402		
				7.48"	10.12"	8.43"	QL80	70.8					
				190	257	214	SD8	64.4					
				7.48"	10.12"	8.43"	DHD360	58.0					
	190D		Normal	190	257	214	QL60	57.5	14.9	190C Pilot bit	UN190D-06-R-403		
				7.48"	10.12"	8.43"	SD6	60.5					
				190	257	214	DHD380	71.2					
				7.48"	10.12"	8.43"	QL80	70.8					
	190X		Multi use	190	253	214	SD8	64.4	13.9	190C Pilot bit	UM190D-08-R-404		
				7.48"	9.96"	8.43"	DHD360	58.0					
				190	253	214	QL60	57.5					
				7.48"	9.96"	8.43"	SD6	60.5					
6.0 (0.24")	201A	Single pass	201	257	228	DHD380	78.9	13.2		US201A-08-R-302			
			7.91"	10.12"	8.98"	QL80	78.5						
						SD8	72.1						

Note 1) Normal model enables to be re-used in case of short hole drilling.

Note 2) To order, please advise the system type, casing size / hammer size and the ring bit models.

Note 3) Special types are also available according to customer's request.

# Standard Type ULTRA MAXBIT / DTH

Unit: mm (Upper)  
inch (Bottom)

Casing Pipe		Type	Ring Bit			Pilot Bit			Ring Set (Ring Bit & Casing Shoe)	Compatible Part	System Part Number	
Outer Dia.	Wall Max. Thickness		Model	Inner Dia.	Outer Dia.	Outer Dia.	Hammer	Weight (kg)				Weight (kg)
D <sub>2</sub>	t			D <sub>4</sub>	D <sub>1</sub>	D <sub>3</sub>						
<b>CASING PIPE ø254.0mm (10")</b>												
254.0 (10")	12.7 (0.50")	200X	Multi use	200	262	226	DHD380	78.3	15.4		UM200X-08-R-408	
				7.87"	10.31"	8.90"	QL80	77.9				
							SD8	71.5				
<b>CASING PIPE ø267.4mm (10 17/32")</b>												
267.4 (10 17/32")	9.3 (0.37")	223A	Single pass	223	281	246.5	DHD380	90.9	15.0		US223A-08-R-066	
				8.78"	11.06"	9.70"	QL80	90.5				
									SD8	84.1		
		223A	Normal	223	281	246.5	DHD380	90.9	15.1		UN223A-08-R-067	
				8.78"	11.06"	9.70"	QL80	90.5				
									SD8	84.1		
	223W	Multi use	223	278	246.5	DHD380	90.9	14.2	223A Pilot bit	UM223W-08-R-409		
			8.78"	10.94"	9.70"	QL80	90.5					
								SD8	84.1			
	7.8 (0.31")	223C	Single pass	223	281	246.5	DHD380	90.9	15.3	223A Pilot bit 223A Ring bit	US223C-08-R-410	
				8.78"	11.06"	9.70"	QL80	90.5				
									SD8	84.1		
223C		Normal	223	281	246.5	DHD380	90.9	15.4	223A Pilot bit 223A Ring bit	UN223C-08-R-411		
	8.78"		11.06"	9.70"	QL80	90.5						
							SD8	84.1				
6.6 (0.26")	223B	Single pass	223	281	246.5	DHD380	90.9	15.5	223A Pilot bit 223A Ring bit	US223B-08-R-412		
			8.78"	11.06"	9.70"	QL80	90.5					
								SD8	84.1			
	223B	Normal	223	281	246.5	DHD380	90.9	15.5	223A Pilot bit 223A Ring bit	UN223B-08-R-251		
8.78"			11.06"	9.70"	QL80	90.5						
							SD8	84.1				
<b>CASING PIPE ø273.0mm (10 3/4")</b>												
273.0 (10 3/4")	12.7 (0.50")	219A	Single pass	219	284	245	DHD380	90.0	17.7		US219A-08-R-050	
				8.62"	11.18"	9.65"	QL80	89.6				
									SD8	83.2		
		219A	Normal	219	284	245	DHD380	90.0	18.0		UN219A-08-R-097	
				8.62"	11.18"	9.65"	QL80	89.6				
									SD8	83.2		
	219W	Multi use	219	281	245	DHD380	90.0	16.6	219A Pilot bit	UM219W-08-R-413		
			8.62"	11.06"	9.65"	QL80	89.6					
								SD8	83.2			
	10.0 (0.39")	219B	Single pass	219	284	245	DHD380	90.0	18.3	219A Pilot bit 219A Ring bit	US219B-08-R-414	
				8.62"	11.18"	9.65"	QL80	89.6				
									SD8	83.2		
		219B	Normal	219	284	245	DHD380	90.0	18.6	219A Pilot bit 219A Ring bit	UN219B-08-R-415	
	8.62"			11.18"	9.65"	QL80	89.6					
								SD8	83.2			
	8.0 (0.31")	228A	Normal	228	284	252.5	DHD380	93.8	15.2		UN228A-08-R-054	
				8.98"	11.18"	9.94"	QL80	93.4				
									SD8	87.0		
232A		Single pass	232	284	255	DHD380	97.3	13.6		US232A-08-R-061		
	9.13"		11.18"	10.04"	QL80	96.9						
							SD8	90.5				
232A	Normal	232	284	255	DHD380	97.3	13.8		UN232A-08-R-034			
		9.13"	11.18"	10.04"	QL80	96.9						
							SD8	90.5				
9.2 (0.36")	232C	Normal	232	284	253	DHD380	96.8	13.6	232A Ring bit	UN232C-08-R-192		
			9.13"	11.18"	9.96"	QL80	96.4					
							SD8	90.0				
6.3 (0.25")	232D	Normal	232	284	253	DHD380	96.8	14.1	232C Pilot bit 232A Ring bit	UN232D-08-R-210		
			9.13"	11.18"	9.96"	QL80	96.4					
								SD8	90.0			
	232W	Multi use	232	304	253	DHD380	96.8	18.1	232C Pilot bit	UM232W-08-R-278		
9.13"			11.97"	9.96"	QL80	96.4						
							SD8	90.0				

To be continued

# DIMENSIONS

## Standard Type ULTRA MAXBIT / DTH

Unit: mm (Upper)  
inch (Bottom)

Casing Pipe		Type	Ring Bit			Pilot Bit			Ring Set (Ring Bit & Casing Shoe)	Compatible Part	System Part Number				
Outer Dia.	Wall Max. Thickness		Model	Inner Dia.	Outer Dia.	Outer Dia.	Hammer	Weight (kg)				Weight (kg)			
D <sub>2</sub>	t			D <sub>4</sub>	D <sub>1</sub>	D <sub>3</sub>									
<b>CASING PIPE ø300.0mm (11 13/16")</b>															
300.0 (11 13/16")	8.0 (0.31")	254A	Single pass	254	315	281	DHD380	112.0	17.2		US254A-08-R-273				
				10.00"	12.40"	11.06"	QL80	111.6							
							SD8	105.2							
<b>CASING PIPE ø318.5mm (12 17/32")</b>															
318.5 (12 17/32")	10.3 (0.41")	270A	Single pass	270	335	295	DHD380	121.4	20.0		US270A-08-R-418				
				10.63"	13.19"	11.61"	QL80	121.0							
							SD8	114.6							
		270A	Normal	270	335	295	DHD310	143.5	20.4			UN270A-10-R-069			
				10.63"	13.19"	11.61"	SD10	139.5							
		270X	Multi use	270D	Single pass	270	335	295	DHD380	121.4	19.1	270A Pilot bit	UM270X-08-R420		
						10.63"	13.19"	11.61"	QL80	121.0					
									SD8	114.6					
	270D			Normal	270	335	295	DHD310	143.5	20.5	270A Pilot bit 270A Ring bit		US270D-10-R-437		
					10.63"	13.19"	11.61"	SD10	139.5						
	270C	Normal	270D	Single pass	270	335	295	DHD310	143.5	20.9	270A Pilot bit 270A Ring bit	UN270D-10-R-438			
					10.63"	13.19"	11.61"	SD10	139.5						
			270C	Normal	270	335	295	DHD310	143.5				21.2	270A Pilot bit 270A Ring bit	UN270C-10-R-348
					10.63"	13.19"	11.61"	SD10	139.5						

Note 1) Normal model enables to be re-used in case of short hole drilling.

Note 2) To order, please advise the system type, casing size / hammer size and the ring bit models.

Note 3) Special types are also available according to customer's request.

# Standard Type ULTRA MAXBIT / DTH

Unit: mm (Upper)  
inch (Bottom)

Casing Pipe		Type	Ring Bit			Pilot Bit			Ring Set (Ring Bit & Casing Shoe)	Compatible Part	System Part Number		
Outer Dia.	Wall Max. Thickness		Model	Inner Dia.	Outer Dia.	Outer Dia.	Hammer	Weight (kg)				Weight (kg)	
D <sub>2</sub>	t			D <sub>4</sub>	D <sub>1</sub>	D <sub>3</sub>							
<b>CASING PIPE ø323.9mm (12 3/4")</b>													
<b>323.9 (12 3/4")</b>	<b>12.7 (0.50")</b>	273A	Single pass	273	338	296	DHD380	123.5	21.2		US273A-08-R-051		
				10.75"	13.31"	11.65"	QL80	123.1					
							SD8	116.7					
		273W	Multi use	273	333	296	DHD380	123.5	20.2			273A Pilot bit	UM273W-08-R-215
				10.75"	13.11"	11.65"	QL80	123.1					
							SD8	116.7					
	<b>10.0 (0.39")</b>	273C	Single pass	273	338	298	DHD380	124.5	21.5	273A Ring bit	US273C-08-R439		
				10.75"	13.31"	11.73"	QL80	124.1					
							SD8	117.7					
		273C	Normal	273	338	298	DHD380	124.5	21.7			273A Ring bit	UN273C-08-R440
				10.75"	13.31"	11.73"	QL80	124.1					
							SD8	117.7					
	273X	Multi use	273	338	298	DHD380	124.5	20.0	273C Pilot bit	UM273X-08-R-257			
			10.75"	13.31"	11.73"	QL80	124.1						
						SD8	117.7						
	<b>8.0 (0.31")</b>	281A	Single pass	281	338	305	DHD380	130.0			17.6		US281A-08-R-214
				11.06"	13.31"	12.01"	QL80	129.6					
							SD8	123.2					
		281A	Normal	281	338	305	DHD380	130.0	17.8		UN281A-08-R-074		
				11.06"	13.31"	12.01"	QL80	129.6					
							SD8	123.2					
				281	338	305	DHD310	150.0					
				11.06"	13.31"	12.01"	SD10	146.0					
281A		Normal	281	338	305	DHD112	173.0	17.8		UN281A-10-R-091			
			11.06"	13.31"	12.01"	QL120	203.0						
						NUMA11/120	182.0						
			11.06"	13.31"	12.01"	NUMA125	194.0						
						SD12	173.0						
281W		Multi use	281	333	305	DHD380	130.0	16.3	281A Pilot bit	UM281W-08-R-216			
			11.06"	13.11"	12.01"	QL80	129.6						
						SD8	123.2						
	281		333	305	DHD310	150.0							
281W	Multi use	11.06"	13.11"	12.01"	SD10	146.0	16.3	281A Pilot bit	UM281W-10-R-267				
<b>6.4 (0.25")</b>	281B	Normal	281	338	305	DHD380	130.0	18.2	281A Pilot bit 281A Ring bit	UN281B-08-R-339			
			11.06"	13.31"	12.01"	QL80	129.6						
						SD8	123.2						
			281	338	305	DHD310	150.0						
	281B	Normal	11.06"	13.31"	12.01"	SD10	146.0	18.2	281A Pilot bit 281A Ring bit	UN281B-10-R-441			
281X	Multi use	281	333	305	DHD380	130.0	16.7	281A Pilot bit	UM281X-08-R-340				
		11.06"	13.11"	12.01"	QL80	129.6							
					SD8	123.2							
		281	333	305	DHD310	150.0							
281X	Multi use	11.06"	13.11"	12.01"	SD10	146.0	16.7	281A Pilot bit	UM281X-10-R442				

To be continued 

# DIMENSIONS

## Standard Type ULTRA MAXBIT / DTH

Unit: mm (Upper)  
inch (Bottom)

Casing Pipe		Type	Ring Bit			Pilot Bit			Ring Set (Ring Bit & Casing Shoe)	Compatible Part	System Part Number		
Outer Dia.	Wall Max. Thickness		Model	Inner Dia.	Outer Dia.	Outer Dia.	Hammer	Weight (kg)				Weight (kg)	
D <sub>2</sub>	t			D <sub>4</sub>	D <sub>1</sub>	D <sub>3</sub>							
<b>CASING PIPE ø355.6mm (14")</b>													
<b>355.6 (14")</b>	<b>12.7 (0.50")</b>	300A	Normal	300	370	327	DHD112	189.5	25.3		UN300A-12-R-055		
				11.81"	14.57"		12.87"	QL120				219.5	
								NUMA11/120				198.5	
								NUMA125				210.5	
								SD12				189.5	
				300	370		327	DH310				167.5	
		11.81"	14.57"	12.87"	SD10	163.5							
		300W	Multi use	300	370	327	DHD112	189.5		24.2	300A Pilot bit	UM300W-12-R-443	
				11.81"	14.57"		12.87"	QL120					219.5
								NUMA11/120					198.5
								NUMA125					210.5
								SD12					189.5
	300			370	327		DH310	167.5					
	11.81"	14.57"	12.87"	SD10	163.5								
	<b>9.5 (0.37")</b>	300B	Single pass	300	370	333.5	DH310	169.0	25.3			US300B-10-R-487	
				11.81"	14.57"		13.13"	SD10					169.0
		300B	Normal	300	370	333.5	DHD112	191	25.6			UN300B-12-R-445	
				11.81"	14.57"		13.13"	QL120					221
								NUMA11/120					200
								NUMA125		222			
								SD12		191			
				300	370		333.5	DH310		169			
		11.81"	14.57"	13.13"	SD10	165							
		300X	Multi use	300	370	333.5	DHD112	191		24.4	300B Pilot bit	UM300X-12-R-447	
11.81"				14.57"	13.13"		QL120	221					
							NUMA11/120	200					
	NUMA125						222						
	SD12						191						
300	370			333.5	DH310		169						
11.81"	14.57"	13.13"	SD10	165									
<b>7.9 (0.31")</b>	300C	Normal	300	370	333.5	DHD112	191	25.6	300B Pilot bit 300B Ring bit		UN300C-12-R-347		
			11.81"	14.57"		13.13"	QL120					221	
							NUMA11/120					200	
			11.81"	14.57"		13.13"	NUMA125					222	
SD12	191												
<b>6.3 (0.25")</b>	300D	Normal	300	370	333.5	DHD112	191	26.4	300B Pilot bit 300B Ring bit	UN300D-12-R-357			
			11.81"	14.57"		13.13"	QL120				221		
							NUMA11/120				200		
			11.81"	14.57"		13.13"	NUMA125				222		
SD12	191												

Note 1) Normal model enables to be re-used in case of short hole drilling.

Note 2) To order, please advise the system type, casing size / hammer size and the ring bit models.

Note 3) Special types are also available according to customer's request.

# Standard Type ULTRA MAXBIT / DTH

Unit: mm (Upper)  
inch (Bottom)

Casing Pipe		Type	Ring Bit			Pilot Bit			Ring Set (Ring Bit & Casing Shoe)	Compatible Part	System Part Number	
Outer Dia.	Wall Max. Thickness		Model	Inner Dia.	Outer Dia.	Outer Dia.	Hammer	Weight (kg)				Weight (kg)
D <sub>2</sub>	t			D <sub>4</sub>	D <sub>1</sub>	D <sub>3</sub>						
<b>CASING PIPE ø406.4mm (16")</b>												
406.4 (16")	12.7 (0.50")	354A	Single pass	354	420	378	DHD112	233	27.0		US354A-12-R-105	
				13.94"	16.54"		14.88"	QL120				263
								NUMA11/120				242
					NUMA125	264						
					SD12	233						
		354X	Multi use	354	420	378	DHD112	233	26.0	354A Pilot bit	UM354X-12-R-263	
	13.94"			16.54"	14.88"		QL120	263				
							NUMA11/120	242				
					NUMA125	264						
					SD12	233						
10.0 (0.39")	354B	Single pass	354	420	378	DHD112	233	27.9	354A Pilot bit 354A Ring bit	US354B-12-R-294		
			13.94"	16.54"		14.88"	QL120				263	
							NUMA11/120				242	
				NUMA125	264							
				SD12	233							
<b>CASING PIPE ø457.2mm (18")</b>												
457.2 (18")	12.7 (0.50")	393A	Single pass	393	472	426	DHD112	274	37.8		US393A-12-R-128	
				15.47"	18.58"		16.77"	QL120				304
								NUMA11/120				283
					NUMA125	305						
					SD12	274						
		393W	Multi use	393	472	426	DHD112	274	36.5	393A Pilot bit	UM393W-12-R-457	
	15.47"			18.58"	16.77"		QL120	304				
							NUMA11/120	283				
					NUMA125	305						
					SD12	274						
10.0 (0.39")	393B	Single pass	393	472	426	DHD112	274	38.8	393A Pilot bit 393A Ring bit	US393B-12-R-458		
			15.47"	18.58"		16.77"	QL120				304	
							NUMA11/120				283	
				NUMA125	305							
				SD12	274							

To be continued 

# DIMENSIONS

## Standard Type ULTRA MAXBIT / DTH

Unit: mm (Upper)  
inch (Bottom)

Casing Pipe		Type	Ring Bit			Pilot Bit			Ring Set (Ring Bit & Casing Shoe)	Compatible Part	System Part Number	
Outer Dia. D <sub>2</sub>	Wall Max. Thickness t		Model	Inner Dia. D <sub>4</sub>	Outer Dia. D <sub>1</sub>	Outer Dia. D <sub>3</sub>	Hammer	Weight (kg)				Weight (kg)
<b>CASING PIPE ø508.0mm (20")</b>												
508.0 (20")	16.0 (0.63")	445B	Single pass	445	521	473	DHD112	356	41.0		US445B-12-R-153 *OVER SIZE	
				17.52"	20.51"	18.62"	QL120	386				
							NUMA11/120	365				
							NUMA125	387				
							SD12	356				
					445	521	473	DHD112S		423	445B Pilot bit	US445B-15-R-112
		17.52"	20.51"	18.62"	NUMA120S	447						
					SD15S	459						
					QL200	445						
					NUMA180	506						
					SD18	544						
		445W	Multi use	445	521	473	DHD112	356	39.1	445B Pilot bit	UM445W-12-R-451 *OVER SIZE	
	17.52"			20.51"	18.62"	QL120	386					
						NUMA11/120	365					
						NUMA125	387					
						SD12	356					
				445	521	473	DHD112S	423		445B Pilot bit	UM445W-15-R-452	
	17.52"	20.51"	18.62"	NUMA120S	447							
				SD15S	459							
				QL200	445							
				NUMA180	506							
				SD18	544							
	445D	Single pass	445	521	473	DHD112S	423	41.8	445B Pilot bit 445B Ring bit	US445D-15-R-241		
17.52"			20.51"	18.62"	NUMA120S	447						
					SD15S	459						
					QL200	445						
					NUMA180	506						
					SD18	544						
	445X	Multi use	445	521	473	DHD112S	423		40.1	445B Pilot bit	UM445X-15-R-454	
17.52"			20.51"	18.62"	NUMA120S	447						
					SD15S	459						
					QL200	445						
					NUMA180	506						
					SD18	544						
	445A	Single pass	445	521	473	DHD112	356	42.2		445B Pilot bit 445B Ring bit	US445A-12-R-290 *OVER SIZE	
17.52"			20.51"	18.62"	QL120	386						
					NUMA11/120	365						
					NUMA125	387						
					SD12	356						
			445	521	473	DHD112S	423		445B Pilot bit 445B Ring bit	US445A-15-R-111		
17.52"	20.51"	18.62"	NUMA120S	447								
			SD15S	459								
			QL200	445								
			NUMA180	506								
			SD18	544								
	10.0 (0.39")	445C	Single pass	445	521	473	QL200	445	43.6	445B Pilot bit 445B Ring bit	US445C-18-R-150	
17.52"				20.51"	18.62"	NUMA180	506					
							SD18	544				
<b>CASING PIPE ø558.8mm (22")</b>												
558.8 (22")	14.0 (0.55")	494A	Single pass	494	573	523	QL200	509	47.2		US494A-18-R-162	
				19.45"	22.56"	20.59"	NUMA180	570				
					SD18	608						
		494W	Multi use	494	573	523	QL200	509	45.1	494A Pilot bit	UM494W-18-R-449	
	19.45"			22.56"	20.59"	NUMA180	570					
				SD18	608							
	12.7 (0.50")	494B	Single pass	494	573	523	QL200	509	47.9	494A Pilot bit 494A Ring bit	US494B-18-R-436	
				19.45"	22.56"	20.59"	NUMA180	570				
				SD18	608							
	494X	Multi use	494	573	523	QL200	509	45.7	494A Pilot bit	UM494X-18-R-450		
19.45"			22.56"	20.59"	NUMA180	570						
			SD18	608								

\*Over size : No shank breakage warranty.

Note 1) Normal model enables to be re-used in case of short hole drilling.

Note 2) To order, please advise the system type, casing size / hammer size and the ring bit models.

Note 3) Special types are also available according to customer's request.

# Standard Type ULTRA MAXBIT / DTH

Unit: mm (Upper)  
inch (Bottom)

Casing Pipe		Type	Ring Bit			Pilot Bit			Ring Set (Ring Bit & Casing Shoe)	Compatible Part	System Part Number		
Outer Dia.	Wall Max. Thickness		Model	Inner Dia.	Outer Dia.	Outer Dia.	Hammer	Weight (kg)				Weight (kg)	
D <sub>2</sub>	t			D <sub>4</sub>	D <sub>1</sub>	D <sub>3</sub>							
<b>CASING PIPE ø609.6mm (24")</b>													
609.6 (24")	16.0 (0.63")	545A	Single pass	545	625	574	QL200	590	51.4		US545A-18-R-129		
				21.46"	24.61"	22.60"	NUMA180	651					
		545W	Multi use	545	625	574	QL200	590					
		21.46"		24.61"	22.60"	NUMA180	651						
	12.7 (0.50")	552A	Single pass	552	625	580	QL200	595	46.7		US552A-18-R-147		
				21.73"	24.61"	22.83"	NUMA180	656					
		552W	Multi use	552	625	580	QL200	595					
		21.73"		24.61"	22.83"	NUMA180	656						
<b>CASING PIPE ø711.0mm (28")</b>													
711.0 (28")	16.0 (0.63")	630A	Single pass	630	726	654	QL200	771	77.0		US630A-18-R-117 *OVER SIZE		
				24.80"	28.58"	25.75"	NUMA180	832					
				630	726	654	SD18	870					
				24.80"	28.58"	25.75"	NUMA240	1032					
		630W	Multi use	630	726	654	QL200	771			73.0	630A Pilot bit	UM630W-18-R-429 *OVER SIZE
				24.80"	28.58"	25.75"	NUMA180	832					
				630	726	654	SD18	870					
				24.80"	28.58"	25.75"	NUMA240	1032					
	14.0 (0.55")	630B	Single pass	630	726	654	QL200	771	78.0	630A Pilot bit			US630B-18-R-152 *OVER SIZE
				24.80"	28.58"	25.75"	NUMA180	832					
				630	726	654	SD18	870					
				24.80"	28.58"	25.75"	NUMA240	1032					
	12.7 (0.50")	630C	Single pass	630	726	654	QL200	771			79.0	630A Pilot bit 630A Ring bit	US630C-18-R-426 *OVER SIZE
				24.80"	28.58"	25.75"	NUMA180	832					
				630	726	654	SD18	870					
				24.80"	28.58"	25.75"	NUMA240	1032					
<b>CASING PIPE ø812.8mm (32")</b> *Please contact us for further discussion.													
812.8 (32")	16.0 (0.63")	738A	Single pass	738	832	776							
				29.06"	32.76"	30.55"							
		738W	Multi use	738	832	776							
				29.06"	32.76"	30.55"							
	12.7 (0.50")	738B	Single pass	738	832	776							
				29.06"	32.76"	30.55"							
<b>CASING PIPE ø914.4mm (36")</b> *Please contact us for further discussion.													
914.4 (36")	16.0 (0.63")	838A	Single pass	838	932	877							
				32.99"	36.69"	34.53"							
		838W	Multi use	838	932	877							
				32.99"	36.69"	34.53"							
<b>CASING PIPE ø1016mm (40")</b> *Please contact us for further discussion.													
1016 (40")	16.0 (0.63")	920A	Single pass	920	1035	973							
				36.22"	40.75"	38.31"							
		920W	Multi use	920	1035	973							
				36.22"	40.75"	38.31"							

\*Over size : No shank breakage warranty.

# DIMENSIONS

## Big Bore Type ULTRA MAXBIT / DTH

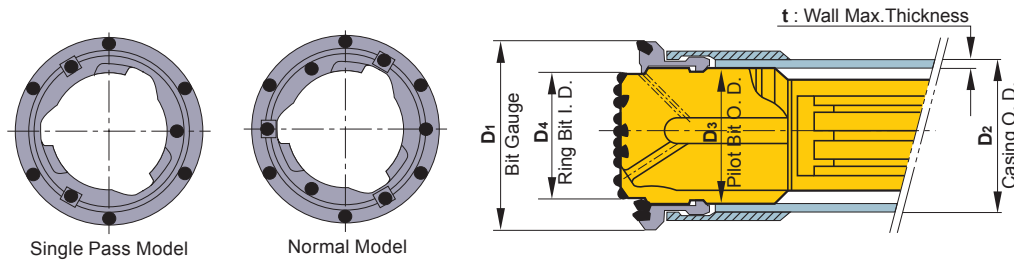

Unit: mm (Upper)  
inch (Bottom)

Casing Pipe		Type	Ring Bit			Pilot Bit			Ring Set (Ring Bit & Casing Shoe)	Compatible Part	System Part Number
Outer Dia. D <sub>2</sub>	Wall Max. Thickness t		Model	Inner Dia. D <sub>4</sub>	Outer Dia. D <sub>1</sub>	Outer Dia. D <sub>3</sub>	Hammer	Weight (kg)			
<b>CASING PIPE ø114.3mm (4 1/2")</b>											
114.3 (4 1/2")	8.0 (0.31")	086L	Single pass for RD-pile	86	137	96	DHD3.5	6.9	4.8		UB086L-03-R-222
				3.39"	5.39"	3.78"	COP34	7.5			
							COP32	6.9			
							86	137	96	W80	7.8
			3.39"	5.39"	3.78"						
5.6 (0.22")	092L	Large bore hole (Single pass)	92	137	101.5	DHD3.5	8.6	4.4		UB092L-03-R-229	
			3.62"	5.39"	4.00"	COP34	9.2				
						COP32	8.6				
<b>CASING PIPE ø139.7mm (5 1/2")</b>											
139.7 (5 1/2")	10.0 (0.39")	106L	Single pass for RD-pile	106	166	118	DHD340	10.7	7.7		UB106L-04-R-223
				4.17"	6.54"	4.65"	QL40	12.0			
							SD4	11.8			
							106	166	118	W100	10.7
				4.17"	6.54"	4.65"					
	5.6 (0.22")	116L	Large bore hole (Single pass)	116	161	127	DHD340	13.7	5.4		UB116L-04-R-230
4.57"				6.34"	5.00"	QL40	15.0				
				SD4	14.8						
118L		Large bore hole (Single pass)	118	161	127	DHD340	14.0	5.3		UB118L-04-R-335	
	4.65"		6.34"	5.00"	QL40	15.3					
					SD4	15.1					
<b>CASING PIPE ø168.3mm (6 5/8")</b>											
168.3 (6 5/8")	12.5 (0.49")	127L	Single pass for RD-pile	127	195	141	DHD350	20.0	9.7		UB127L-05-R-224
				5.00"	7.68"	5.55"	QL50	19.5			
							SD5	19.4			
							127	195	141	W120	19.8
				5.00"	7.68"	5.55"					
	6.3 (0.25")	141M	Large bore hole (Single pass)	141	189	154	DHD350	24.5	6.7	141L Ring set	UB141M-05-R-247
				5.55"	7.44"	6.06"	QL50	24.0			
					SD5	23.9					
		141M	Large bore hole (Single pass)	141	189	154	DHD350	24.5	7.0		UB141M-05-R-246
	5.55"			7.44"	6.06"	QL50	24.0				
						SD5	23.9				
	5.6 (0.22")	141L	Large bore hole (Single pass)	141	189	155	DHD350	24.5	6.7		UB141L-05-R-231
5.55"				7.44"	6.10"	QL50	24.0				
				SD5	23.9						
141L		Large bore hole (Single pass)	141	189	155	DHD350	24.5	6.7		UB141L-05-R-276	
			5.55"	7.44"	6.10"	QL50	24.0				
						SD5	23.9				
143L	Large bore hole (Single pass)	143	189	155	DHD350	25.0	6.6		UB143L-05-R-336		
		5.63"	7.44"	6.10"	QL50	24.5					
					SD5	24.4					
<b>CASING PIPE ø177.8mm (7")</b>											
177.8 (7")	7.0 (0.28")	153L	Large bore hole (Normal)	153	200	162	DHD360	31.2	7.2		UB153L-06-R-244
				6.02"	7.87"	6.38"	QL60	30.7			
					SD6	33.7					
		154L	Large bore hole (Normal)	154	200	162	DHD360	31.0	7.1		UB154L-06-R-260
6.06"	7.87"			6.38"	QL60	30.5					
					SD6	33.5					

\*1 Actual hammer model.

Note 1) To order, please advise the system type, casing size / hammer size and the ring bit models.  
Note 2) Special types are also available according to customer's request.

# Big Bore Type ULTRA MAXBIT / DTH

## System Part Number

### U B 086L - 03 - R - 222

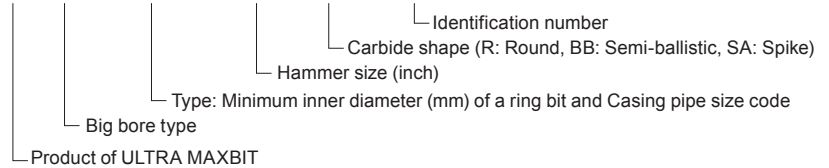

Unit: mm (Upper)  
inch (Bottom)

Casing Pipe		Type	Ring Bit			Pilot Bit			Ring Set (Ring Bit & Casing Shoe)	Compatible Part	System Part Number
Outer Dia. D <sub>2</sub>	Wall Max. Thickness t		Model	Inner Dia. D <sub>4</sub>	Outer Dia. D <sub>1</sub>	Outer Dia. D <sub>3</sub>	Hammer	Weight (kg)			
<b>CASING PIPE ø193.7mm (7 5/8")</b>											
193.7 (7 5/8")	10.0 (0.39")	162L	Large bore hole (Single pass)	162	215	172	W150	31.0	8.8		UB162LW1536R232 *1
				6.38"	8.46"	6.77"					
	6.3 (0.25")	167L	Large bore hole (Single pass)	167	215	179	DHD360	35.0	8.1		UB167L-06-R-233
				6.57"	8.46"	7.05"	QL60	34.5			
			167	215	179	W150	35.0	8.1	UB167LW1536R234 *1		
			6.57"	8.46"	7.05"						
<b>CASING PIPE ø216.3mm (8 17/32")</b>											
216.3 (8 17/32")	8.2 (0.32")	187M	Large bore hole (Single pass)	187	235	197	W151	40.0	8.8	187L Pilot bit	UB187MW1536R292 *1
				7.36"	9.25"	7.76"					
<b>CASING PIPE ø219.1mm (8 5/8")</b>											
219.1 (8 5/8")	12.5 (0.49")	177L	Single pass for RD-pile	177	250	191	DHD360	33.5	13.6		UB177L-06-R-225
				6.97"	9.84"	7.52"	QL60	33.0			
							SD6	36.0			
	10.0 (0.39")	187L	Single pass for RD-pile	177	250	191	W150	33.5	13.6		UB177LW1536R228 *1
				6.97"	9.84"	7.52"					
				187	252	197	DHD360	40.0	11.9		
7.36"	9.92"	7.76"	QL60	39.5							
			SD6	42.5							
6.3 (0.25")	192L	Large bore hole (Single pass)	187	252	197	W150	40.0	11.9	UB187LW1536R221 *1		
			7.36"	9.92"	7.76"						
			192	242	204	DHD360	41.5	9.4	UB192L-06-R-235		
			7.56"	9.53"	8.03"	QL60	41.0				
						SD6	44.0				
<b>CASING PIPE ø273.0mm (10 3/4")</b>											
273.0 (10 3/4")	12.7 (0.50")	232L	Large bore hole (Single pass)	232	297	245	W150	60.0	16.4		UB232LW1536R254 *1
				9.13"	11.69"	9.65"					
	10.0 (0.39")	238L	Large bore hole (Single pass)	238	297	251	W150	65.0	14.9		UB232LW1536R236 *1
				9.37"	11.69"	9.88"					
	8.0 (0.31")	242L	Large bore hole (Single pass)	242	297	255	DHD380	81.0	13.8		UB242L-08-R-237
				9.53"	11.69"	10.04"	QL80	80.6			
						SD8	74.4				
<b>CASING PIPE ø323.9mm (12 3/4")</b>											
323.9 (12 3/4")	10.0 (0.39")	284L	Large bore hole (Single pass)	284	350	301	DHD380	104.5	20.0		UB284L-08-R-238
				11.18"	13.78"	11.85"	QL80	104.1			
							SD8	97.9			
<b>CASING PIPE ø355.6mm (14")</b>											
355.6 (14")	10.0 (0.39")	315L	Large bore hole (Single pass)	315	380	332	DHD380	163.5	21.1		UB315L-12-R-355
				12.40"	14.96"	13.07"	QL80	163.1			
							SD8	156.9			

\*1 Actual hammer model.

\*2 Over size : No shank breakage warranty.

# DIMENSIONS

## Top Hammer Type ULTRA MAXBIT / Top Hammer

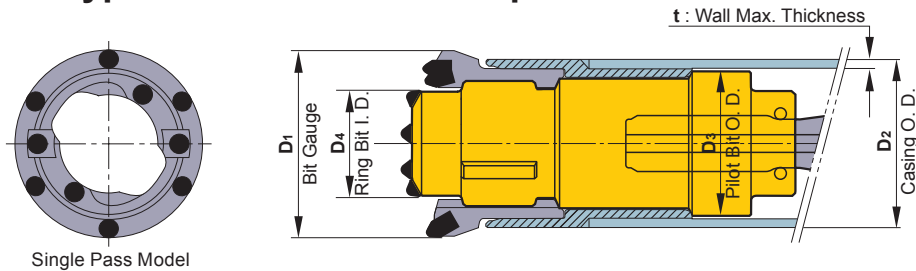

Unit: mm (Upper)  
inch (Bottom)

Casing Pipe		Type	Ring Bit			Pilot Bit			Ring Set (Ring Bit & Casing Shoe)	Compatible Part	System Part Number
Outer Dia. D <sub>2</sub>	Wall Max. Thickness t		Model	Inner Dia. D <sub>4</sub>	Outer Dia. D <sub>1</sub>	Outer Dia. D <sub>3</sub>	Thread	Weight (kg)			
<b>CASING PIPE ø76.3mm (3")</b>											
76.3 (3")	8.0 (0.31")	042A	Single pass	42 1.65"	86 3.39"	58.5 2.30"	R32	1.8	2.3	UT042AR32BBL370	
<b>CASING PIPE ø88.9mm (3 1/2")</b>											
88.9 (3 1/2")	9.5 (0.37")	050B	Single pass	50 1.97"	95 3.74"	67.5 2.66"	T38	3.3	2.9	050A Ring bit UT050BM38BBL304	
		050B	Single pass	50 1.97"	100 3.94"	67.5 2.66"	T38	3.3	3.1	UT050BM38BBL168	
	8.0 (0.31")	050A	Single pass	50 1.97"	95 3.74"	67.5 2.66"	T38	3.3	2.9	050B Pilot bit UT050AM38BBL323	
		050A	Single pass	50 1.97"	100 3.94"	67.5 2.66"	T38	3.3	3.1	050B Pilot bit 050B Ring bit UT050AM38BBL324	
	7.0 (0.28")	050C	Single pass	50 1.97"	95 3.74"	67.5 2.66"	T38	3.3	3.0	050B Pilot bit 050A Ring bit UT050CM38BBL305	
			Single pass	50 1.97"	100 3.94"	67.5 2.66"	T38	3.3	3.2	050B Pilot bit 050B Ring bit UT050CM38BBL303	
		056E	Single pass	56 2.20"	100 3.94"	73.5 2.89"	T38	3.5	2.4	UT056EM38BBL268	
	6.35 (0.25")	056B	Single pass	56 2.20"	100 3.94"	74 2.91"	T38	3.6	2.6	056A Ring bit UT056BM38BBL140	
	4.0 (0.16")	056A	Single pass	56 2.20"	100 3.94"	78 3.07"	T38	3.5	2.6	UT056AM38BBL133	
	<b>CASING PIPE ø101.6mm (4")</b>										
	101.6 (4")	10.0 (0.39")	060D	Single pass	60 2.36"	114 4.49"	79 3.11"	T38	4.5	4.0	060A Pilot bit UT060DM38BBL359
				Single pass	60 2.36"	114 4.49"	81 3.19"	T38	4.6	4.0	UT060AM38BBL306
9.5 (0.37")		060A	Single pass	60 2.36"	114 4.49"	81 3.19"	T38	4.6	4.1	060A Pilot bit 060A Ring bit UT060BM38BBL307	
			Single pass	60 2.36"	114 4.49"	81 3.19"	T38	4.6	4.2	060A Pilot bit 060A Ring bit UT060CM38BBL325	
7.0 (0.28")		065A	Single pass	65 2.56"	114 4.49"	85 3.35"	T38	5.3	3.6	UT065AM38BBL269	

Note 1) To order, please advise the system type, casing size / thread size and the ring bit models.

Note 2) Special types are also available according to customer's request.

# Top Hammer Type ULTRA MAXBIT / Top Hammer

## System Part Number

**U T 072A M38 BB L095**

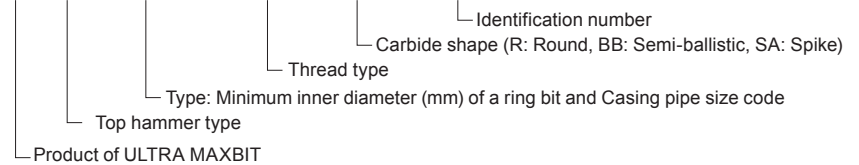

Unit: mm (Upper)  
inch (Bottom)

Casing Pipe		Type	Ring Bit			Pilot Bit			Ring Set (Ring Bit & Casing Shoe)	Compatible Part	System Part Number	
Outer Dia. D <sub>2</sub>	Wall Max. Thickness t		Model	Inner Dia. D <sub>4</sub>	Outer Dia. D <sub>1</sub>	Outer Dia. D <sub>3</sub>	Thread	Weight (kg)				
<b>CASING PIPE ø114.3mm (4 1/2")</b>												
114.3 (4 1/2")	10.0 (0.39")	072A	Single pass	72	126	92	T38	6.0	4.7		UT072AM38BBL095	
				2.83"	4.96"	3.62"						
				72	126	92	T45	6.2	4.7			UT072AM45BBL106
				2.83"	4.96"	3.62"						
	9.5 (0.37")	072C	Single pass	72	126	93	T38	6.7	4.7	UT072CM38BBL308		
				2.83"	4.96"	3.66"						
				72	126	93	T45	6.9	4.7		UT072CM45BBL362	
				2.83"	4.96"	3.66"						
	8.0 (0.31")	072D	Single pass	72	126	93	T38	6.7	4.8	072C Pilot bit 072C Ring bit		UT072DM38BBL309
				2.83"	4.96"	3.66"						
				72	126	93	T45	6.9	4.8	072C Pilot bit 072C Ring bit	UT072DM45BBL363	
				2.83"	4.96"	3.66"						
7.0 (0.28")	072E	Single pass	72	126	93	T38	6.7	4.9	072C Pilot bit 072C Ring bit	UT072EM38BBL326		
			2.83"	4.96"	3.66"							
			72	126	93	T45	6.7	4.9	072C Pilot bit 072C Ring bit		UT072EM45BBL364	
			2.83"	4.96"	3.66"							
	076B	Single pass	76	126	98	T38	7.2	4.3		UT076BM38BBL270		
			2.99"	4.96"	3.86"							
<b>CASING PIPE ø139.7mm (5 1/2")</b>												
139.7 (5 1/2")	10.0 (0.39")	097A	Single pass	97	150	117.5	T45	11.7	5.7		UT097AM45BBL096	
				3.82"	5.91"	4.63"						
				97	150	117.5	T51	11.9	5.7			UT097AM51BBL365
				3.82"	5.91"	4.63"						
	9.5 (0.37")	097C	Single pass	97	150	118.5	T38	12.0	5.9	097B Pilot bit 097A Ring bit	UT097CM38BBL327	
				3.82"	5.91"	4.66"						
	8.0 (0.31")	097B	Single pass	97	150	118.5	T38	12.0	5.9	097A Ring bit		UT097BM38BBL311
				3.82"	5.91"	4.67"						
				97	150	118.5	T45	11.7	5.9	097A Ring bit	UT097BM45BBL141	
				3.82"	5.91"	4.67"						
	7.0 (0.28")	097D	Single pass	97	150	118.5	T38	12.0	5.9	097B Pilot bit 097A Ring bit		UT097DM38BBL328
				3.82"	5.91"	4.67"						
6.6 (0.26")	100B	Single pass	97	150	123	T38	13.0	5.8		UT100BM38BBL338		
			3.82"	5.91"	4.84"							

## Rotation Speed of Bit

Standard speed is 15–20m/min.  
Refer to the following figure for rotation.  
Select the range of uniform rotation during drilling.

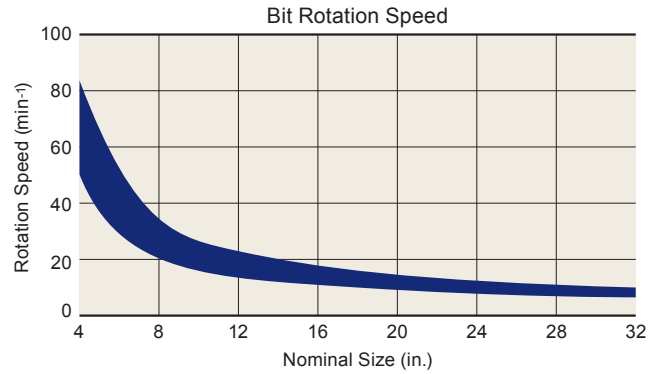

## Setting Compressor

- Pressure
  - Set between 0.7 to 1.0MPa (100–150psi)
  - Consider the depth of underground water when drilling through the layer.  
(In case of 30m (90 ft) depth, add 0.3MPa (45psi) to the air pressure.)
  - Do not set over 1.5MPa (225psi)
- Air Consumption
  - Set the air supply using the following formula.

$$Q = \frac{V(D^2 - d^2)}{1273500}$$

Q : Air supply (m<sup>3</sup>/min)  
D : Inside diameter of casing (mm)  
d : Outside diameter of jacket or hammer (mm)  
V : Air speed 1,100–1,500 (m/min)

Recommended Air Consumption

Nominal Size (in.)	Air Supply	
	(m <sup>3</sup> /min)	(cfm)
4	4-15	140-530
8	19-26	670-920
12	33-45	1,170-1,590
16	42-57	1,480-2,010
20	59-80	2,080-2,830
24	72-98	2,540-3,460
28	81-111	2,860-3,920
32	90-122	3,180-4,310

## APPLICATION EXAMPLES

### ULTRA MAXBIT for RD Pile

- Face of the pilot bit is located at same level of ring bit.  
(Pilot bit does not protrude from the ring bit like other standard ULTRA MAXBIT system)  
This structure make the system stronger against the heavy weight from RD pile.
- Ring bit is bigger than the diameter of "Threaded sleeve splice" shown below illustration for soother drilling.
- Minimum width of the ring bit is same as the width of casing pipe to retain enough strength of RD pile.

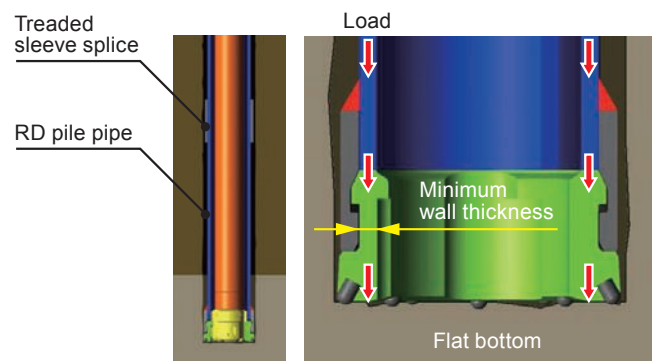

# APPLICATION EXAMPLES

## Foundation construction

Used for improving foundation or for inserting H steel beams.



## Micro pile construction

Possible to efficiently drill in underpinning.



## Well drilling construction

The normal model is recommended if a casing pipe is left in the ground. If not, the multi-use model is recommended.



## Pipe roof and Tunnel fore piling

Efficient and stable operation is possible in inclined or horizontal casing drilling.



# ULTRA MAXBIT

## ORDER SHEET

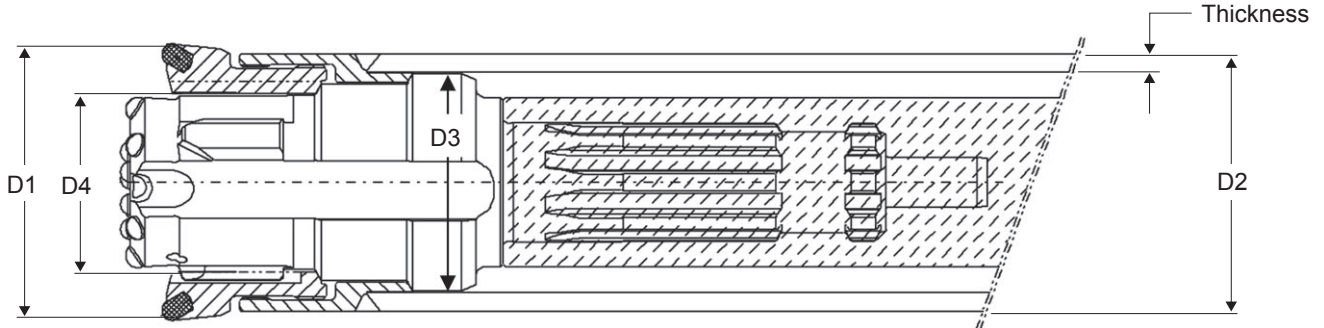

User Name		
Usage		
"DTH Model No. or Thread type"		
Rotation Direction at Drilling	<input type="checkbox"/> Right	<input type="checkbox"/> Left
Drilling Direction	<input type="checkbox"/> Vertical	<input type="checkbox"/> Horizontal <input type="checkbox"/> Diagonal (Angled)
Casing Pipe	Outer diameter (D2)	Wall max. thickness
UMB System	<input type="checkbox"/> Standard	<input type="checkbox"/> Big bore <input type="checkbox"/> Top hammer
Ring Bit Model	<input type="checkbox"/> Single pass	<input type="checkbox"/> Normal <input type="checkbox"/> Multi use
Ring Bit O.D.	(D1)	<input type="checkbox"/> Manufacturer's recommendation
Ring Bit I.D.	(D4)	<input type="checkbox"/> Manufacturer's recommendation
Maximum O.D. of Pilot Bit	(D3)	<input type="checkbox"/> Manufacturer's recommendation
Quantity Demanded	Drilling meter / Number of hole	
Minimum Order Quantity	Pilot Bit: Ring Bit & Casing Shoe:	
Expected Delivery Time		
Remark	Information such as geological conditions, conventionally used bit (a manufacturer), size of passing through bit gauge and hammer type;	

Name of preparer
Phone number

# ULTRA MAXBIT VENTURI MODEL

## Your best partner for drilling in sensitive ground !

- The Flushing air doesn't hit the drilled hole directly.
- Minimal air leakage into the formation won't enlarge the drilled borehole.
- The Reverse flushing causes a vacuum effect to remove the cuttings.
- The Efficient flushing and groove designed by CAE simulation and analysis.

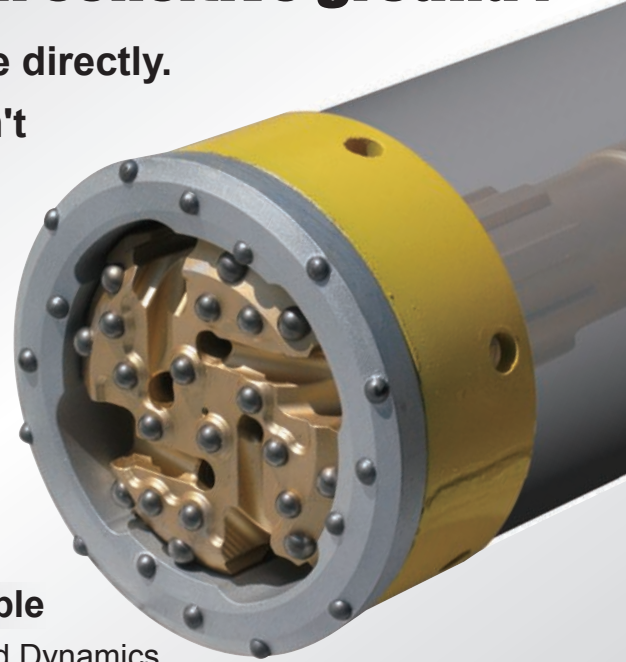

### Air Flushing Simulation and Application Example

Our Flushing Technology confirmed by Computational Fluid Dynamics supply you the best solution for drilling in sensitive ground.

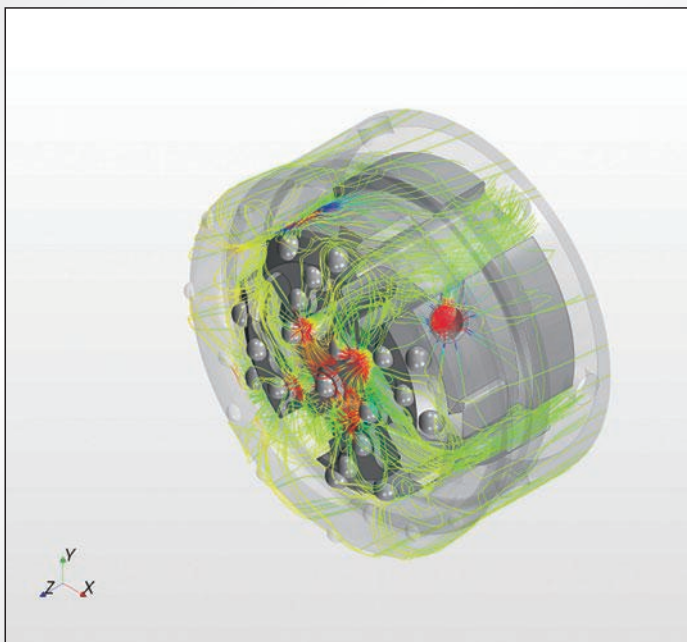

Air Flushing Simulation



Application Example

### Systems



Standard System

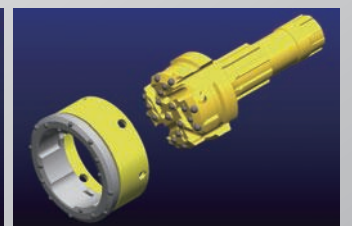

Big Bore System

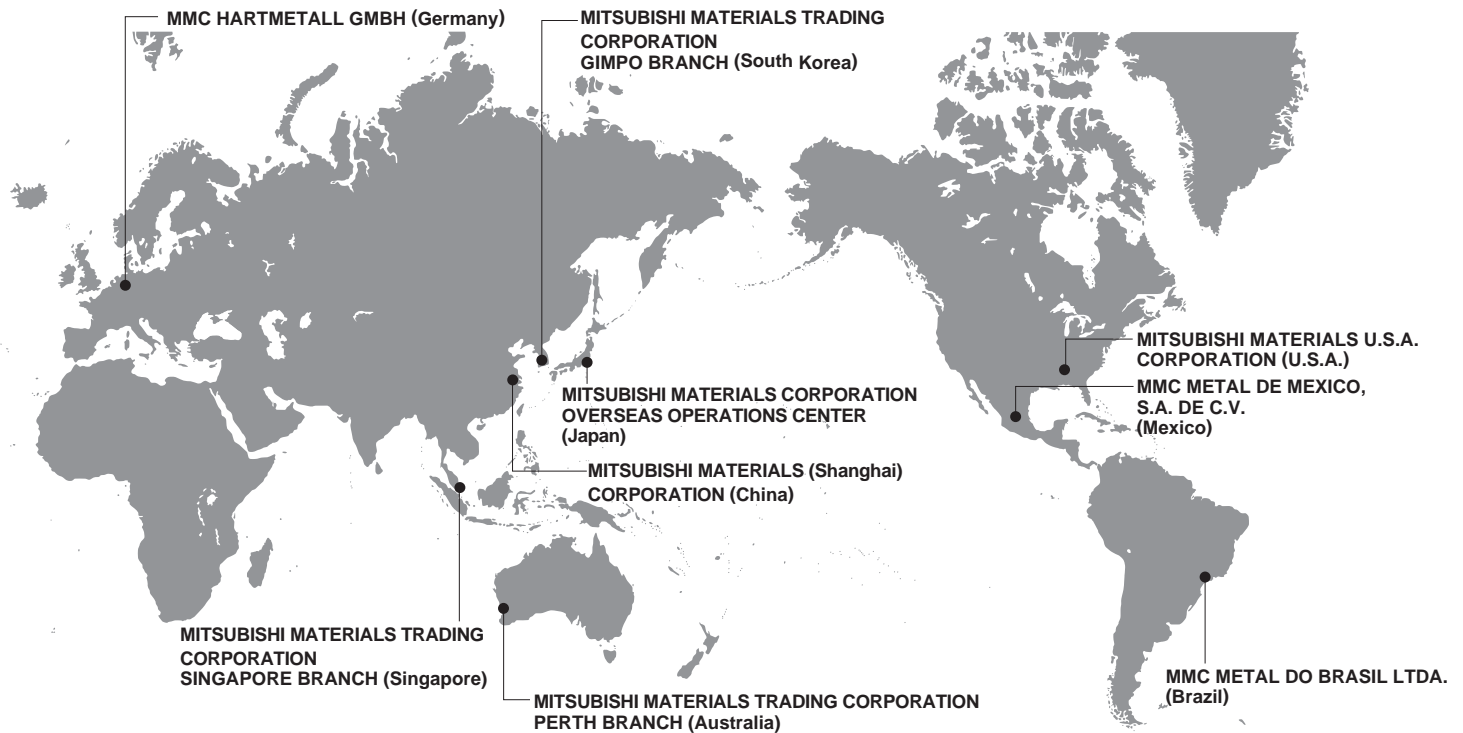

## MITSUBISHI MATERIALS CORPORATION

JAPAN / ROCK TOOLS

**MITSUBISHI MATERIALS CORPORATION  
OVERSEAS OPERATIONS CENTER**

KFC bldg., 7F, 1-6-1, Yokoami, Sumida-ku, Tokyo 130-0015, Japan  
TEL +81-3-5819-8723 FAX +81-3-5819-5259  
E-Mail: [rocktool@mmc.co.jp](mailto:rocktool@mmc.co.jp)

### Subsidiaries of MITSUBISHI MATERIALS CORPORATION

U.S.A.	<b>MITSUBISHI MATERIALS U.S.A. CORPORATION</b> <b>Rock Tools Office</b> 2690 Salisbury Highway, Statesville, NC 28677, U.S.A. TEL +1-800-423-1358 FAX +1-888-834-2248 E-Mail: <a href="mailto:mmusclt@mmus.com">mmusclt@mmus.com</a>	Australia	<b>MITSUBISHI MATERIALS TRADING CORPORATION</b> Unit1, 58 Catalano Circuit Canning Vale, WA 6155 Australia TEL +61-8-6258-7200 FAX +61-8-6258-5614 E-Mail: <a href="mailto:admin@mmtau.com">admin@mmtau.com</a>
Germany	<b>MMC HARTMETALL GMBH</b> Comeniusstr. 2,40670 Meerbusch, Germany TEL +49-2159-9189-32 FAX +49-2159-9189-30079 E-Mail: <a href="mailto:rocktools@mmchg.de">rocktools@mmchg.de</a>	South Korea	<b>MITSUBISHI MATERIALS TRADING CORPORATION</b> 761, Jiwol-Ri, Pattan-Myeon, Hwaseong-Si, Gyeonggi-Do, 445-917 Korea TEL +82-31-8059-1895 FAX +82-31-8059-1897
Brazil	<b>MMC METAL DO BRASIL LTDA.</b> Rua Cincinato Braga, 340 13º andar. Bela Vista- CEP 01333-010 São Paulo-SP., BRASIL TEL +55-11-3262-5095 FAX +55-11-3285-4906 E-Mail: <a href="mailto:mubr@mubr.com.br">mubr@mubr.com.br</a>	Singapore	<b>MITSUBISHI MATERIALS TRADING CORPORATION</b> 10 Anson Road, #32-09 International Plaza, 079903 Singapore TEL +65-6221-7233 FAX +65-6325-4220
Mexico	<b>MMC METAL DE MEXICO S.A. DE C.V.</b> Av. La Canada No.16 Parque Industrial Bernardo Quintana El marques, Queretaro. TEL +52-442-221-6136 +52-442-221-6137 FAX +52-442-221-6134 E-Mail: <a href="mailto:gonzalez@mmcmex.com">gonzalez@mmcmex.com</a>	China	<b>MITSUBISHI MATERIALS (Shanghai) CORPORATION</b> Room 3911, UNITED PLAZA 1468, Nanjing Road West, Shanghai, 200040 China TEL +86-21-6235-0745 FAX +86-21-6235-0741

<http://mrt.mitsubishicarbide.com>

