



Transit

# Always a Perfect Connection

Pioneering solutions for the rail and bus industry



# THE POWER OF CONNECTION

## Connections that take you to a new level

Transmission, charging, and grounding for mobility on rail and road

Schunk is one of the world's leading providers in the field of reliable current transmission. Our developments set technological milestones and constantly push the boundaries of the possible. Benefit from our decades of experience and use our know-how as a development partner.

When it comes to the mobility of the future, nothing will run smoothly without the right connections. Only a perfect contact ensures safe current transmission, allows batteries to charge quickly, and protects sensitive areas from interference currents. Schunk's products are already setting new standards worldwide in all areas of mobility and wherever power needs to be transmitted safely and reliably.

On the rail, our pantographs, grounding contacts, carbon fiber grounding-systems (CFG-Systems), and third-rail current collectors provide the rail industry with innovative ways to make operation safer, more economical, and more reliable.

On the road, our innovative Schunk Smart Charging system opens up completely new possibilities in terms of economy, performance, and flexibility. It charges battery-driven vehicles safely, reliably, and within seconds in the depot or even during operation.

### Everything for your reliable current transmission:

#### PRODUCTS FOR THE RAIL INDUSTRY

Pantograph	Page 06
Third-rail current collector	Page 08
Grounding contacts	Page 10
Carbon fiber grounding (CFG-systems)	Page 11
Wheel flange lubrication	Page 12
Aftermarket	Page 13

#### PRODUCTS FOR ELECTRIC BUSES

Schunk Smart Charging	Page 14
-----------------------	---------

Schunk Service	Page 18
About Schunk	Page 19



## Set the course for success - with our solutions for local and long-distance transportation

Railways play an important role in mobility today and will continue to do so into the future. All the more important that you set the course for success - with Schunk as a competent development partner at your side.

For safe and efficient current transmission, we develop in close coordination with our customers both individual products as well as system solutions that combine robustness, functional reliability, and cost efficiency.

The result is leading technological solutions that are in demand worldwide, for example, pantographs for all speed ranges as well as third-rail current collectors with patented safety technology. Our carbon contact strips, carbon collector shoes, and carbon brushes with brush holders are perfectly matched to our systems.

Moreover, we take care of the currents that lead to impairment of locomotion in rail vehicles or to costly shut-down, in the worst case. High-frequency, stray currents affect the drive shafts during operation, which can severely

damage bearings as well as engine and gearbox components. This is where our CFG-systems help - an efficient and powerful solution that reliably grounds interference currents and provides greater protection.

We provide everything from one source: technology concepts, comprehensive components from our own production, and customer service with individual support - for maintenance, repair, and overhead line test runs.

## Dependable from delivery through operation - you can rely on our pantographs

High availability, efficient lightweight construction, and reliable performance: Schunk pantographs are impressive in operation on high-speed lines as well as local transport.

Our pantographs operate daily all over the world - they are quiet, durable, and economical. In a variety of applications and even under extreme operating conditions, they know only one goal: to avoid costly downtime. Low-wear materials, leading technological systems, and our know-how about the best possible connections ensure that

everything moves along reliably. For example, the excellent material properties of our contact strips in conjunction with the sophisticated design of our pantographs make it possible to compensate for irregularities in the overhead contact line and to ensure the uninterrupted function of the current transmission.



**Pantograph WBL-Z**  
for full and regional trains  
with air bellows drive



**Pantograph SBE**  
for regional public transportation with  
spring drive and electrical lowering device

### For smooth railway operation

Always energized, yet quiet, with reduced weight and compact design - with the world's leading pantographs for railway operations, we offer reliable and long-lasting solutions. Individually spring-supported contact strips create a permanent and reliable contact with the overhead line. Or in other words: You benefit from maximum operational safety with minimal maintenance effort. In addition to two concepts for lowering the pantograph, individual customer adjustments are possible.



- Your most important benefits:**
- Compact pantograph construction
  - Use of lightweight components for high-speed applications
  - Reliable and cost-optimized design
  - Optimally matched overall system with Schunk contact strips in the best quality
  - Comprehensive range of complete pantograph controls
  - Worldwide after-sales service with original components from the manufacturer

**Your contact for our pantographs:**  
 panto-transit@schunk-group.com

- **Integral carbon strip**  
LCC/RAMS-optimized
- **All Carbon strip**  
arc protection
- **Multicomponent carbon strip**  
LCC/RAMS-optimized
- **High-current carbon strip**  
for max. power transmission
- **Ice scraper strip**  
heated/unheated

## Tough as nails

Despite continuous load and climatic stress: Schunk quality carbon contact strips are extremely resilient, durable, and protect the overhead line. This is an investment in maximum operational safety.

Numerous customers have relied for decades on the outstanding product properties of our carbon contact strips. The excellent electrical conductivity and the long service life of our products set new standards for functionally reliable and low-maintenance use. The variety of our materials, which are perfectly matched to the respective requirements, is unique in the industry and enables you to create a completely tailored solution.



Integral carbon strip

### Your most important benefits:

- Unique material diversity and production technology
- Unequaled long service life through the highest quality
- Maintenance- and environmentally-friendly system
- Good electric arc resistance
- Extremely low overhead line wear
- Special and standard solutions for all applications

### Your contact for our contact strips:

✉ carbonstrip-transit@schunk-group.com

## We put you on the rail to success - with our patented third-rail current collectors

Even under the toughest of conditions, third-rail current collectors need to function reliably around the clock. Our leading technology with patented features makes it possible.

Maintenance-friendly Schunk third-rail current collectors are in use worldwide. We offer our customers the optimal solution for every speed range and every operating voltage. Even with fluctuating distances between rail and bogey, our developments ensure perfect current transmission - with precise design and pioneering technology.

You benefit in several ways from our know-how: As one of the largest manufacturers of collector shoes, we can offer you exactly matched complete systems with innovative joining techniques for a secure hold of the system components.

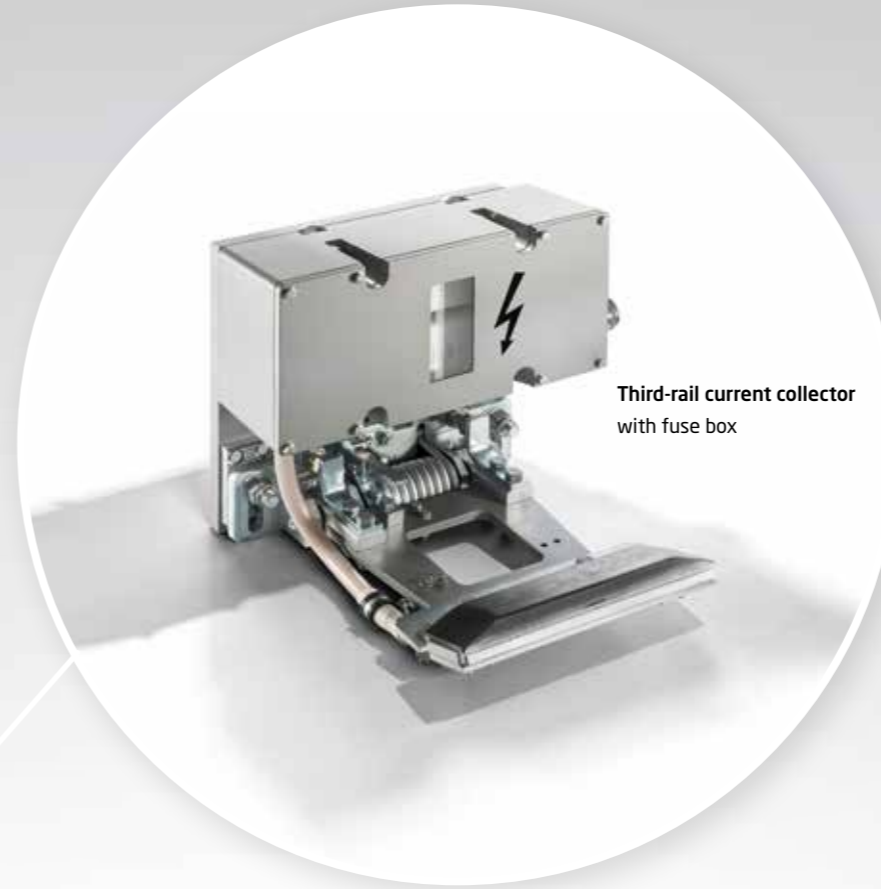

Third-rail current collector with fuse box



Third-rail current collector

### More power in regional public transportation

If overhead lines are not an option, it is time to move to the third rail. Due to its large cross section it can transmit highest currents, but its benefits can only be exploited in conjunction with a powerful and reliable current collector. At this point it is our turn to go on track. Thanks to our versatile, compact, and light third-rail current collector, millions of people around the world travel using public transportation every day. Patented sub system solutions such as a second insulating layer ensure outstanding functional reliability and prevents the ignition of electric arcs.

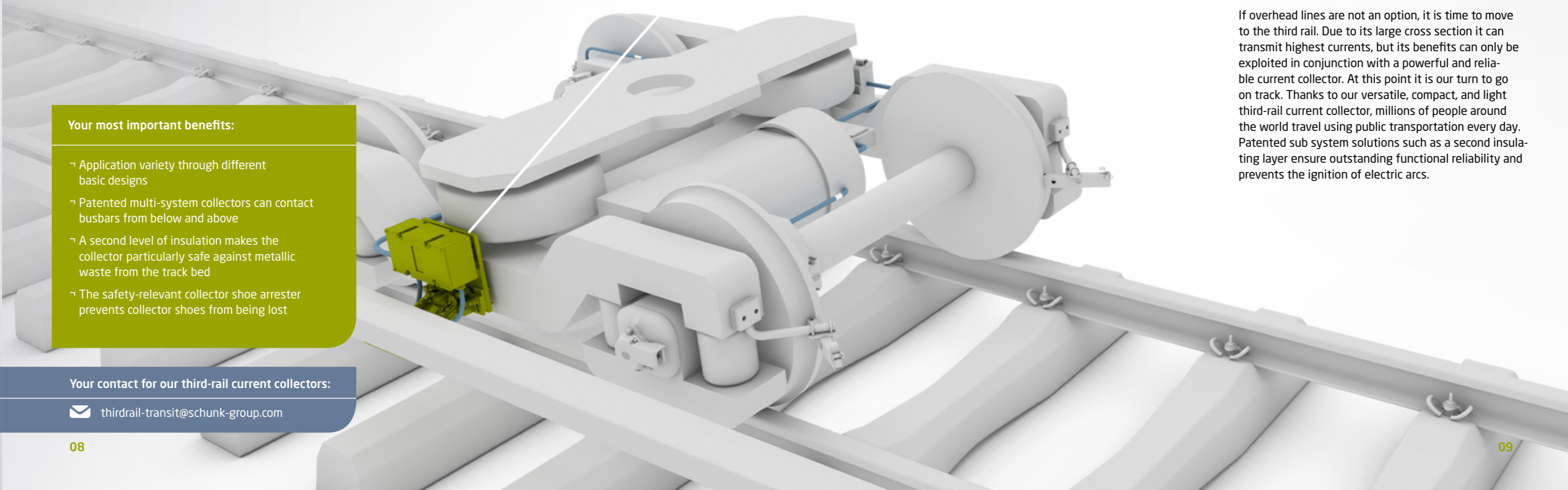

### Your most important benefits:

- Application variety through different basic designs
- Patented multi-system collectors can contact busbars from below and above
- A second level of insulation makes the collector particularly safe against metallic waste from the track bed
- The safety-relevant collector shoe arrester prevents collector shoes from being lost

### Your contact for our third-rail current collectors:

✉ thirtrain-transit@schunk-group.com

### Third-rail carbon collector shoe for composite busbars



### Third-rail carbon collector shoe with overrun/stop protection



### Third-rail cast collector shoe for composite busbars



### Third-rail cast collector shoe for conventional steel busbars

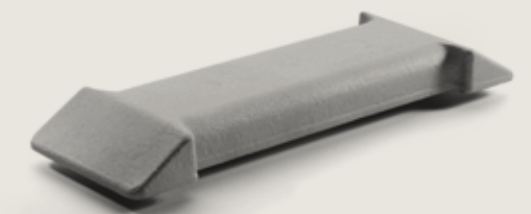

### Third-rail cast collector shoe with integrated predetermined breaking point for conventional steel busbars



## Quality in one piece

Our long-lasting carbon and cast collector shoes are also impressive in continuous operation with maximum power up to the wear limit. They make it extremely easy to create operational safety while keeping maintenance costs.

The basis for the advantages of our collector shoes are the perfectly matched materials. For steel busbars, we offer collector shoes made of cast iron or milled from solid metal. With aluminum busbars with stainless steel supports, our individual carbon materials have proven their worth - we deliver these collector shoes clamped and brazed. Excellent temperature resistance and a stable power level up to the wear limit characterize both versions.

### GROUNDING CONTACTS

**Polyax grounding contact**  
for outboard bearing bogie applications

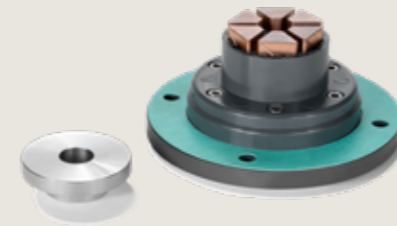

**Polyrad grounding contact**  
for mounting on the gearbox



**Polyax grounding contact**  
for inboard bearing bogie applications



#### Your most important benefits:

- Extremely long service life of all grounding contacts
- Various systems cover all common installation situations and interfaces
- High design and development competence

## Permanently in use for you - our grounding contacts with extremely long service lives

Grounding contacts must function reliably over the longest possible period. Schunk offers long-lasting solutions for all common installation situations and interfaces.

It is no coincidence that leading vehicle manufacturers rely on Schunk grounding systems, because our technology has revolutionized signal current transmission and created new dimensions for maintenance intervals.

Whether versatile all-carbon grounding contacts, or high current density systems, whether axle-end or gear-box mounting position - great material know-how, maximum robustness, low wear, and a very long service life characterize all variants. Of course, our carbon brushes for grounding contacts are also available separately as spare parts.

All-carbon grounding contact



## Perfect protection - with our protective carbon fiber grounding-system

Schunk carbon fiber grounding-systems (CFG-systems) effectively prevent expensive damage and reduce maintenance expenditures.

Motor shafts are affected by currents with lower amperages, but with higher voltages and frequencies. These stray currents can cause devastating damage to rail vehicle drive systems. Our CFG-systems reliably redirect stray shaft currents to the vehicle mass. In this way, they consistently protect rolling bearings and adjacent assemblies in gear-boxes and motors from damage. The unique structure of interwoven carbon fibers ensures optimal contact and high abrasion resistance. Depending on the requirements, our systems can be adapted to the respective drive motor in the bogie and, thanks to their compact dimensions, are also easily retrofitted.

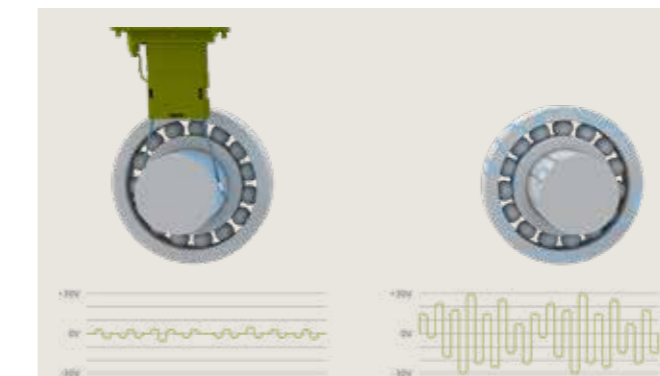
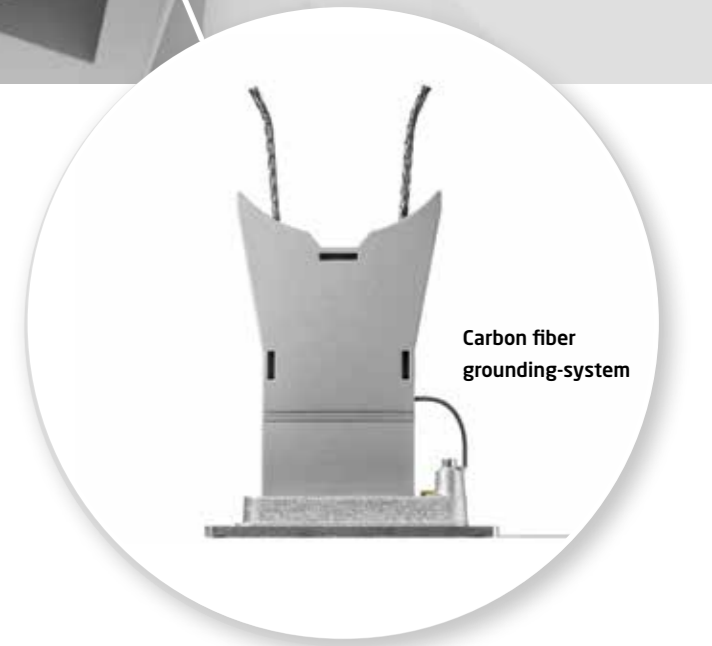

Comparison of interference currents on a ball-bearing drive shaft with and without shaft grounding through a CFG-system

#### Your most important benefits:

- The system prevents expensive bearing damage
- Fast amortization due to lower repair and maintenance costs
- A slim design enables use in compact installation situations on bogies

#### Your contact for our grounding systems:

grounding-transit@schunk-group.com

#### Your most important benefits:

- Materials perfectly matched to your requirements
- Tailored solutions for aluminum busbars with stainless steel supports as well as for steel busbars
- Unequaled long service life through the highest quality
- Maintenance- and environmentally-friendly
- High corrosion resistance
- Best emergency operation properties

#### Your contact for our third-rail collector shoes:

carbonstrip-transit@schunk-group.com

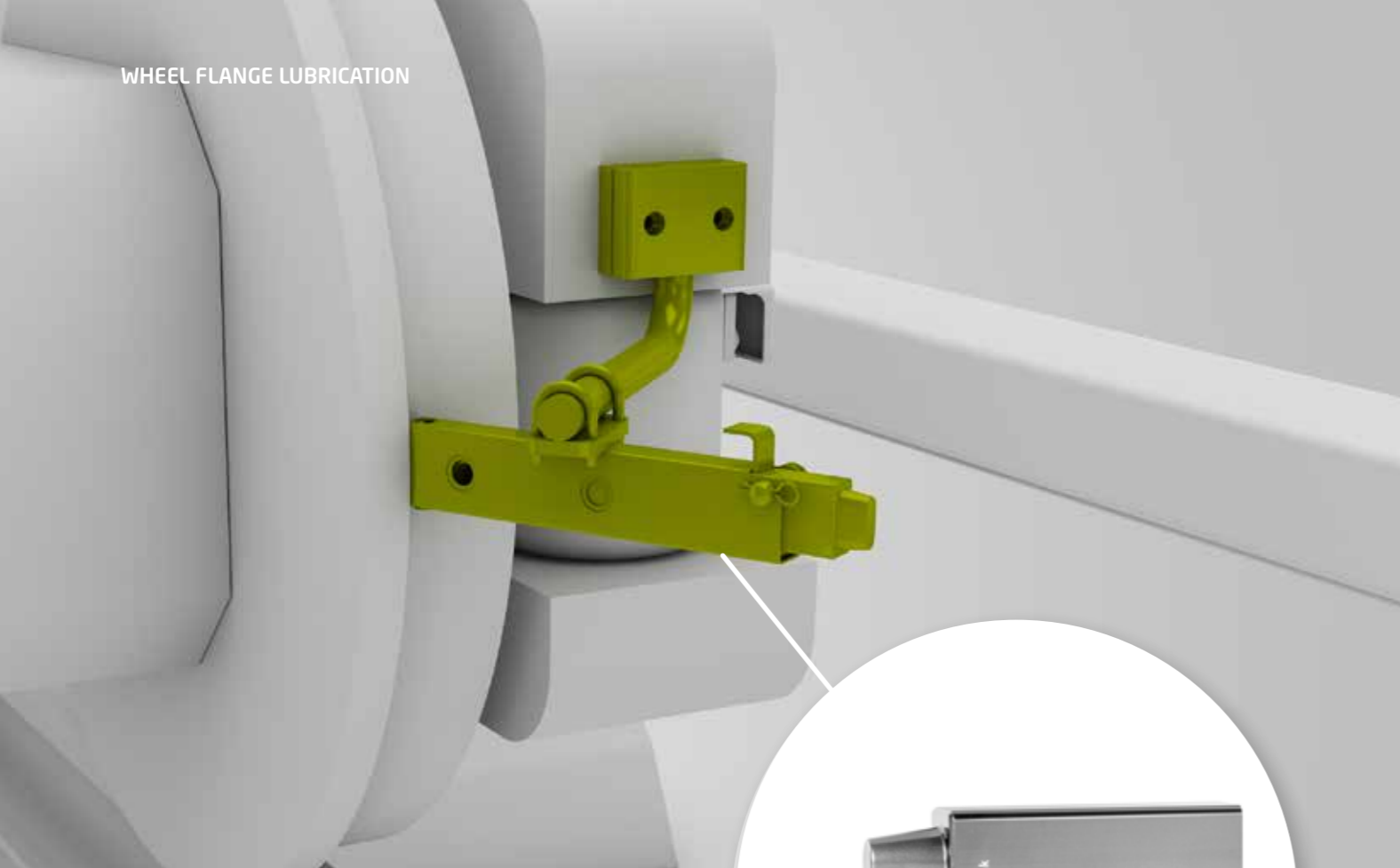

Stick for wheel flange lubrication

## Runs smoothly - thanks to our noiseless wheel flange lubrication

When steel rolls on steel, friction and noise are generated. Wear and operating costs can be measurably reduced with Schunk wheel flange lubrication. It also eliminates annoying squeaking.

Schunk's wheel flange lubrication concept is as simple as it is ingenious: A carbon-based dry lubricant reduces the frictional forces between the wheel flange and rail. A holder with a solid lubricant stick is attached directly to the bogie for this purpose. A spring presses the stick onto the wheel flange where it ensures permanent lubrication in an ideal dosage. The result is significantly lower wear - and thus longer service life of the wheels and rails.

### Your most important benefits:

- Low investment costs
- Economical consumption due to solid lubricant
- Low wear of wheels and rails
- Easiest maintenance and service
- Environmentally friendly: less drive energy required, no oil on the rails, less running noise
- Schunk's material competence facilitates optimal solutions for every requirement

### Your contact for our wheel flange lubrication:

✉ [wfl-transit@schunk-group.com](mailto:wfl-transit@schunk-group.com)

## Current transmission perfected - with the help of our durable carbon brushes and brush holders

Schunk carbon brushes and brush holders have been the driving force in electric motors for decades. Our know-how will continue to benefit you in the future.

Good electrical and thermal conductivity and long service life characterize Schunk carbon brushes. They ensure optimal current transmission under all operating conditions in grounding contacts and traction motors.

We also manufacture brush holders, conductor bands, switching and breaker contacts. All components are developed in close cooperation with leading manufacturers - or according to your individual specifications. Thanks to our tailored materials, we are able to meet even extraordinary requirements.



Long-life carbon brushes for local transportation reduce maintenance outlay

### Conductor shunts



### Brush holders for railway applications



### Contact levers



### Carbon brushes for regional traffic



### Your contact for our aftermarket products:

✉ [brush-transit@schunk-group.com](mailto:brush-transit@schunk-group.com)



## E-mobility is becoming suitable for everyday use

With the innovative Schunk Smart Charging system, you can economically bring e-mobility to your roads today. The system allows electric buses to be charged quickly and reliably along the route or in the depot.

Municipalities and companies are increasingly phasing out diesel-powered units in favor of emission-free, battery-powered vehicles. The most serious problem is the batteries. They must either be large enough for a range of electric buses suitable for everyday use or be recharged more often.

Schunk Smart Charging solves this dilemma in one fell swoop. The innovative charging system opens up completely new possibilities in terms of efficiency, performance, and flexibility due to short charging times and the associated high range of buses. It charges electric buses and battery-powered vehicles safely, reliably, and within seconds in the depot or during operation.

For example, batteries can be charged while passengers board and disembark at a bus stop. Even the full recharge of completely empty batteries is possible in less than 20 minutes. The required battery dimension can be significantly reduced as a result and a highly effective relationship between battery size, passenger load, and range can be achieved.

The extremely flexible system can be customized and optimally integrated into a completely new charging infrastructure or an existing system.



## Next stop: Schunk Smart Charging

Our new roof mounted pantograph SLS 103 is a technological milestone which, thanks to years of development expertise, sets unprecedented standards in the market for conductive, fully automatic electric buses

The compact roof mounted pantograph SLS 103 is mounted on the roof of the electric bus and functions according to the "bus-up" principle: The bus stops beneath the charging station, where the roof mounted pantograph extends, connects to the charging station, and charges the batteries.

Thanks to an extremely fast contacting of less than five seconds, the multi-pole concept with at least four poles and the possible 30-second pulse charge of up to 1 MW, the bus is recharged at lightning speed. The roof-mounted

collector can also be used to reliably charge vehicles of various heights up to double-decker buses. The drive mechanisms of the system compensate for both vehicle movements during reloading as well as parking tolerances: The roof mounted pantograph can also be individually tailored to customer requirements in terms of layout and contact interfaces or adapted to existing infrastructures.



Roof mounted pantograph SLS 103

» No matter how you would like to charge your electric vehicles - Schunk has the right charging system for you.

**Innovative. Process efficient. Functionally reliable.** «

### Your most important benefits:

- Ultra-high current transmission up to 1 MW
- Simple integration through a more compact design
- Higher work area: 1,200 - 2,200 mm
- Fast contacting under 5 seconds
- Safety through multi-pole concept and (fixed/predefined) contact order
- Charges vehicles of different heights (up to a double-decker bus)

### Your contact for our Smart Charging system:

✉ [bus-transit@schunk-group.com](mailto:bus-transit@schunk-group.com)

### Inverted pantograph SLS 201

Our inverted pantograph sets another technological milestone, as it can be easily embedded into existing charging infrastructure.



#### Work area

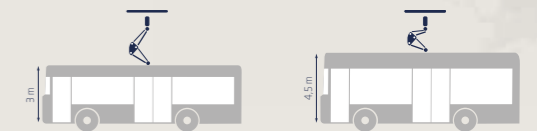

The flexible half-scissor design of the inverted pantograph makes it possible to load different vehicles at a station or loading point.

#### Contact units

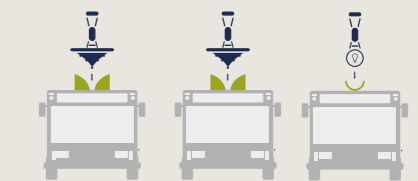

The 4-pole system ensures a constant contact force distribution on all four busbars and reliably compensates for vehicle movements during reloading.

### Your most important benefits:

- Attaches to the infrastructure
- "Top-down" principle when contacting
- High current transmission up to 600 kW
- Compensation of vehicle movements during the charging process
- Impressive spring drive system: no contact interruption during the charging process

## Roof mounted pantograph SLS 102

Our roof mounted pantograph is designed precisely to meet customer requirements in terms of current transmission and availability.

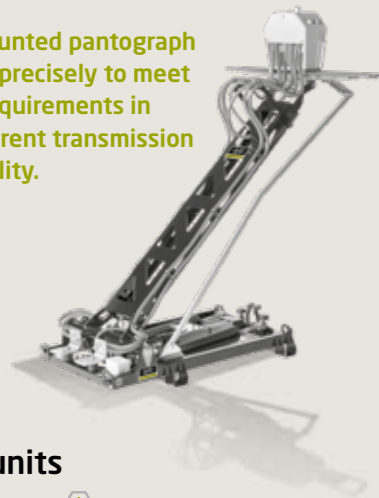

### Contact units

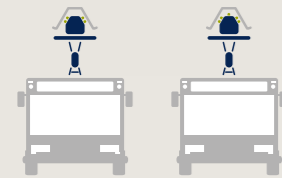

Different contact units can be used depending on the general conditions. All charging options can be carried out with a single system.

### Compensation of tolerances

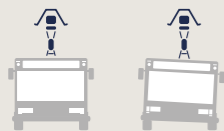

Our drive mechanisms provide fast and efficient recharging - whatever the road conditions. They compensate for vehicle movements during reloading as well as parking tolerances.

### Current transmission

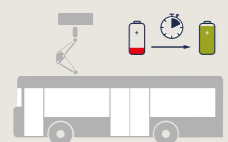

We offer functionally reliable and high current transmission in just a few seconds. This provides an ideal balance between battery size, passenger load, and range.

#### Your most important benefits:

- "Bus-up" principle when contacting
- High current transmission up to 750 kW
- Recharge in just a few seconds
- Excellent compensation of parking tolerances
- Suitable for opportunity charging, flash charging, and depot charging

## SERVICE

# Downtime? Not with our service.

Conducting components are subjected to extreme mechanical, electrical and environmental influences. Regular maintenance by Schunk protects you from costly downtimes and ensures excellent operational safety and cost-effectiveness.

Regular inspections and preventive maintenance are extremely important because they prevent damage, loss of performance, and total failure. Therefore, rely on Schunk's reliable maintenance expertise. For both rail and battery-driven vehicles, our service ensures excellent operational safety, consistent operation, and lasting economic efficiency.

In addition to the professional technical overhaul, a pantograph overhaul also includes an evaluation of the driving data and suggestions for the optimization of function and economy.

For our electric bus charging system, we are at your disposal around the clock to support you with the appropriate commissioning and servicing of vehicles.

## A service strategy that pays off for you

### Savings

Our service reduces or avoids downtime and increases economic efficiency. You save costs for maintenance personnel and spare parts storage, while also tying up less capital and avoiding claims for damages. The low repair costs are also quickly amortized through the increased service life.



### Effectivity

Less downtime allows better utilization of your staff. In addition, you will achieve optimized product and quality control. And your costs are always kept in view. Thanks to flexible delivery times, we also tailor maintenance to your individual requirements and processes.

### Safety

You can expect the highest service quality from us, because we are officially certified according to ISO 9001:2000. Our regular maintenance secures your investments, significantly reduces the risk of hidden defects, and thus increases operational safety. 100 % availability and 100 % functionality - these are our common goals.

Certified by



Your contact for our service department:

service-transit@schunk-group.com

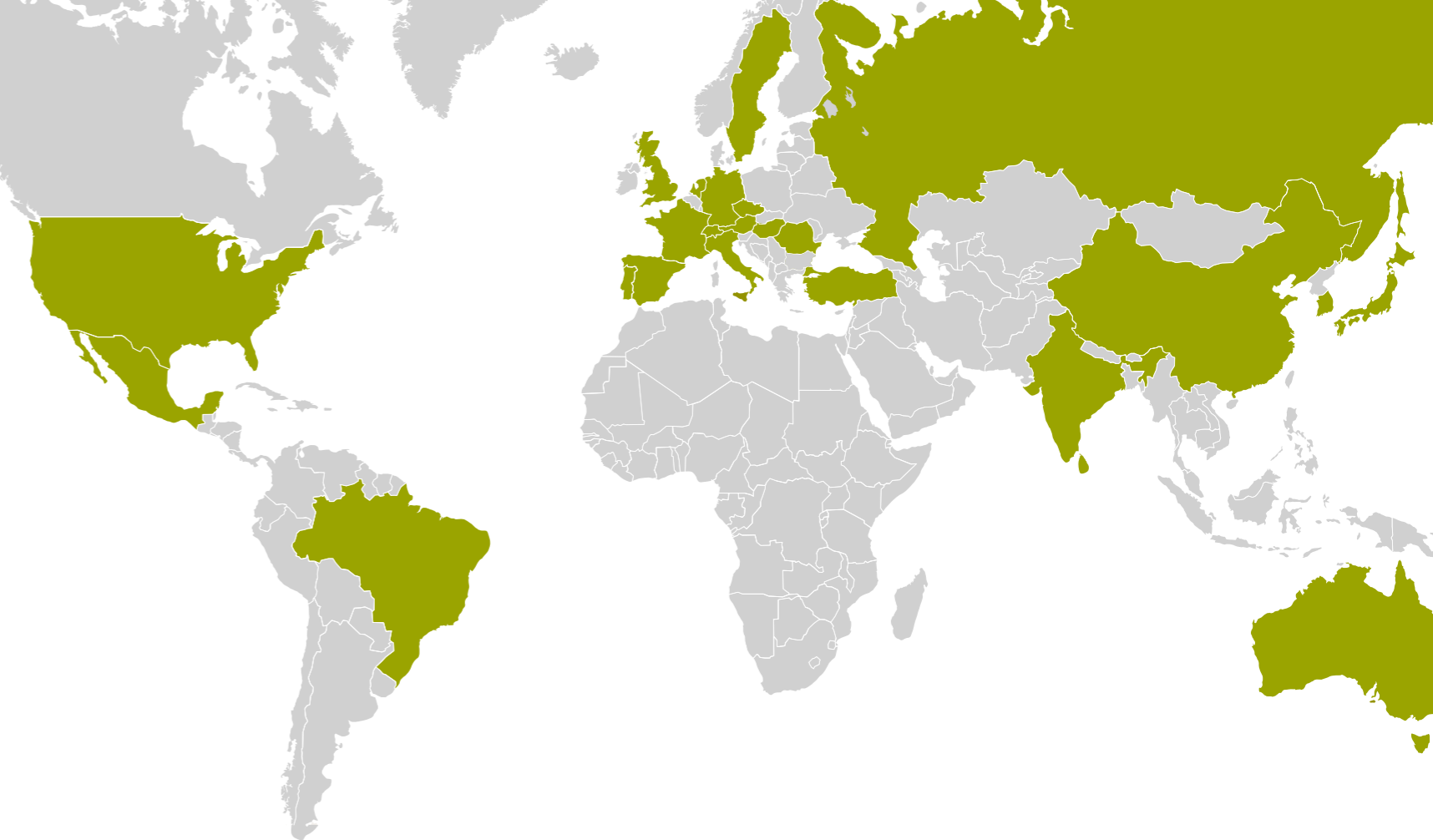

## Schunk - A worldwide success. Always at your side.

Schunk is the world leader in the development, production, and application of carbon, ceramic, quartz and sinter metals solutions. Like no other, Schunk combines innovation and technological know-how with exceptional service orientation to create a range of services that is unique in the market.

Empowering, idea-driven, collaborative - this is how the Schunk Group has made a name for itself since 1913 as a global technology group.

With around 9,500 employees in 29 countries, it is on this basis that the Schunk Group develops tailored high-tech products and systems in a wide variety of areas: We are active in carbon technology and ceramics, environmental simulation and air conditioning technology, sintered metal, ultrasonic welding and optical machines. Our customers benefit from this extensive know-how.

With Schunk, you have a partner who offers you all the technological possibilities of a globally active company and pragmatically puts your ideas into practice. And always tailored exactly to your requirements - for industrial volume markets as well as highly specialized niche markets.

We face the ever-increasing demands of globalization and align our decentralized company structure precisely with your market and applications.

Thanks to our global sales network, we are always nearby worldwide, we have production sites and provide on-site deliveries in numerous countries, and we also coordinate logistics.



9500



29



66

**Schunk Transit Systems GmbH**  
Hauptstrasse 97  
35435 Wettenberg ṡ Germany  
Phone +49 641 803 0  
Fax +49 641 803 139  
Mail [sales.sbi@schunk-group.com](mailto:sales.sbi@schunk-group.com)

**[schunk-carbontechnology.com](http://schunk-carbontechnology.com)**

All specifications are subject to technical change. Texts and pictures are subject to copyright laws.  
Use of the content is not permitted without the written consent of Schunk GmbH.

10.03e/500/2019