

EXPLODED DRAWING A—Model No. 831.14622.1

R1209A

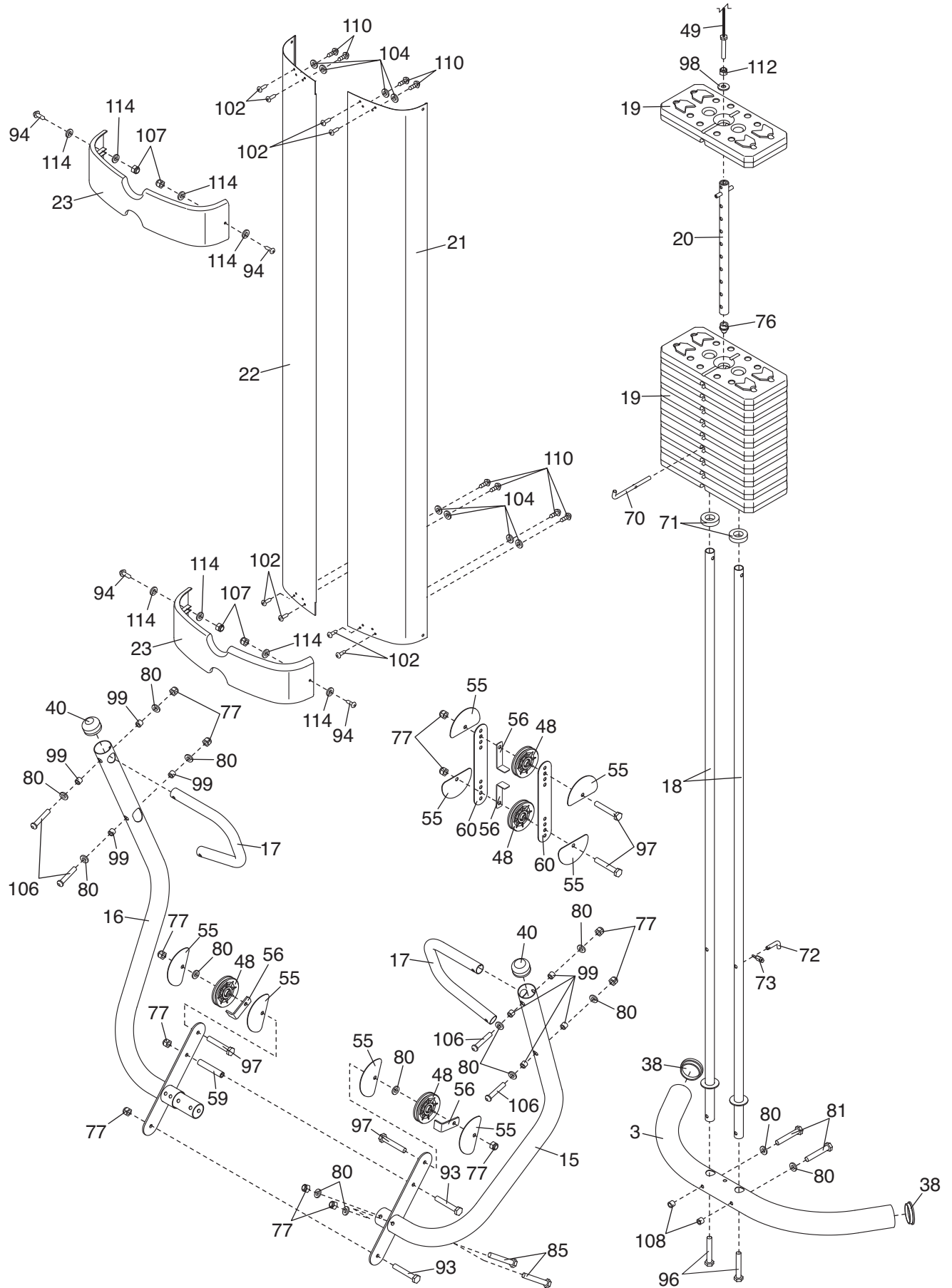

EXPLODED DRAWING B—Model No. 831.14622.1

R1209A

