

EXPLODED DRAWING A

Model No. 831.14922.2 R0417A

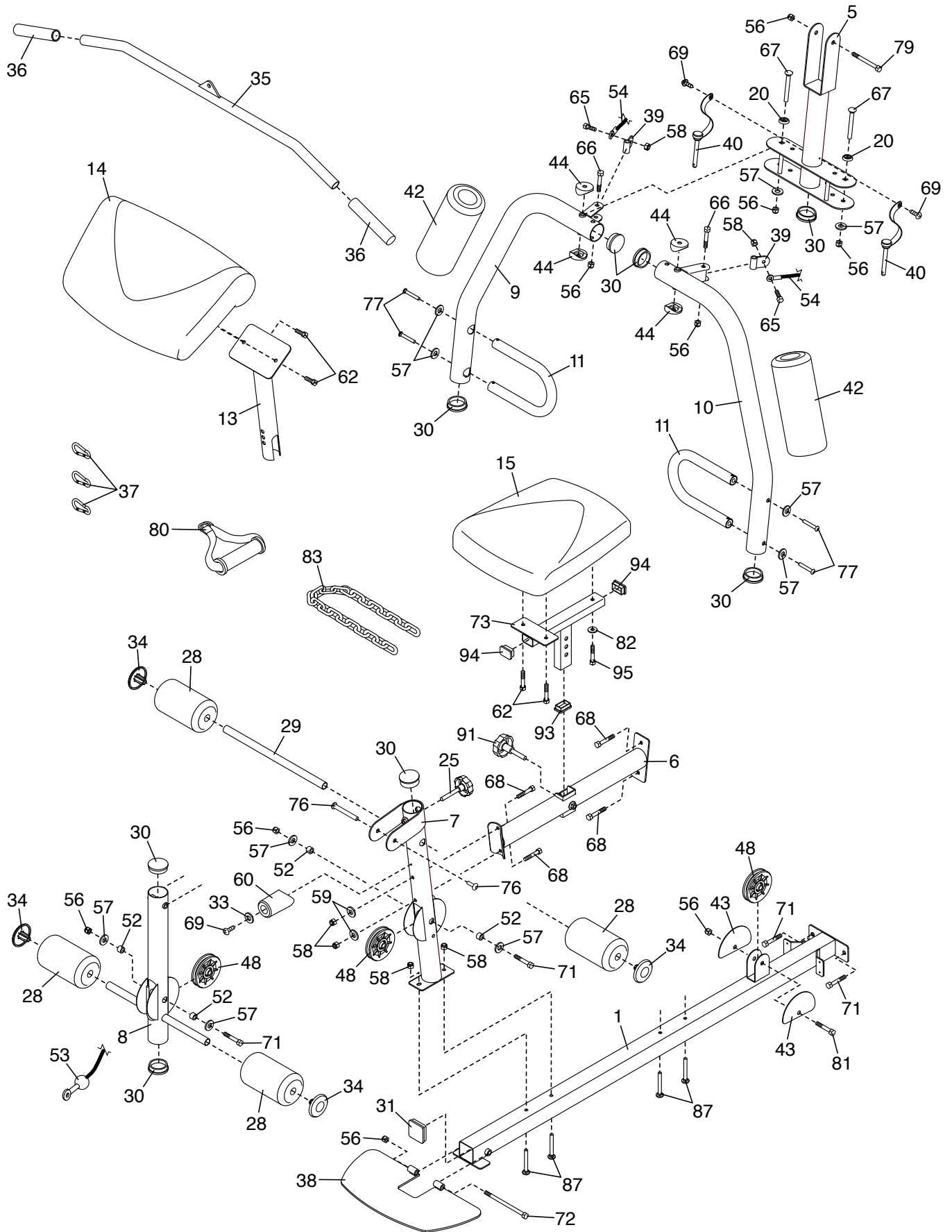

EXPLODED DRAWING B

Model No. 831.14922.2 R0417A

