

EXPLODED DRAWING A—Model No. 831.14922.0

R0710A

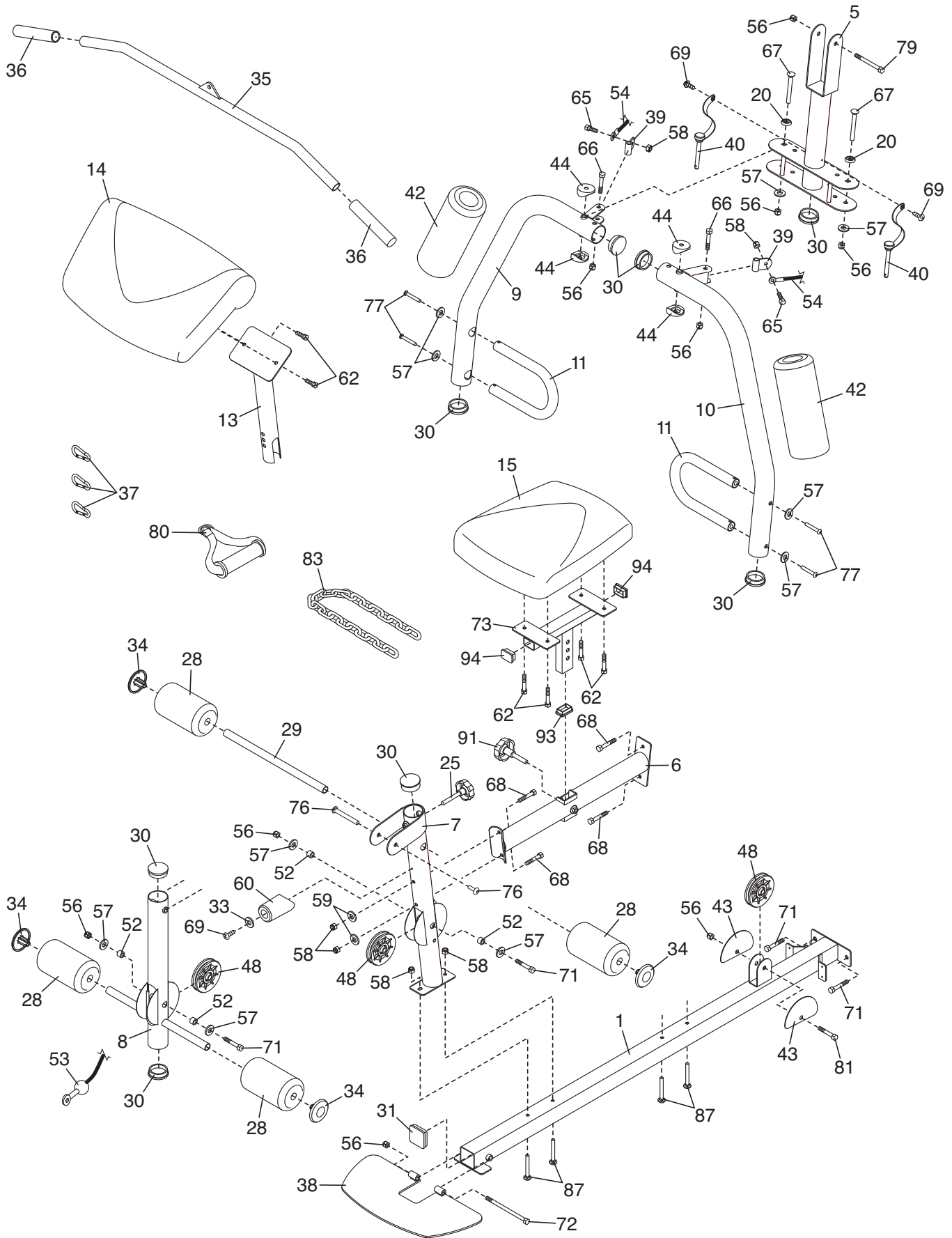

EXPLODED DRAWING B—Model No. 831.14922.0

R0710A

