

EXPLODED DRAWING A—Model No. 831.15629.0

R0905A

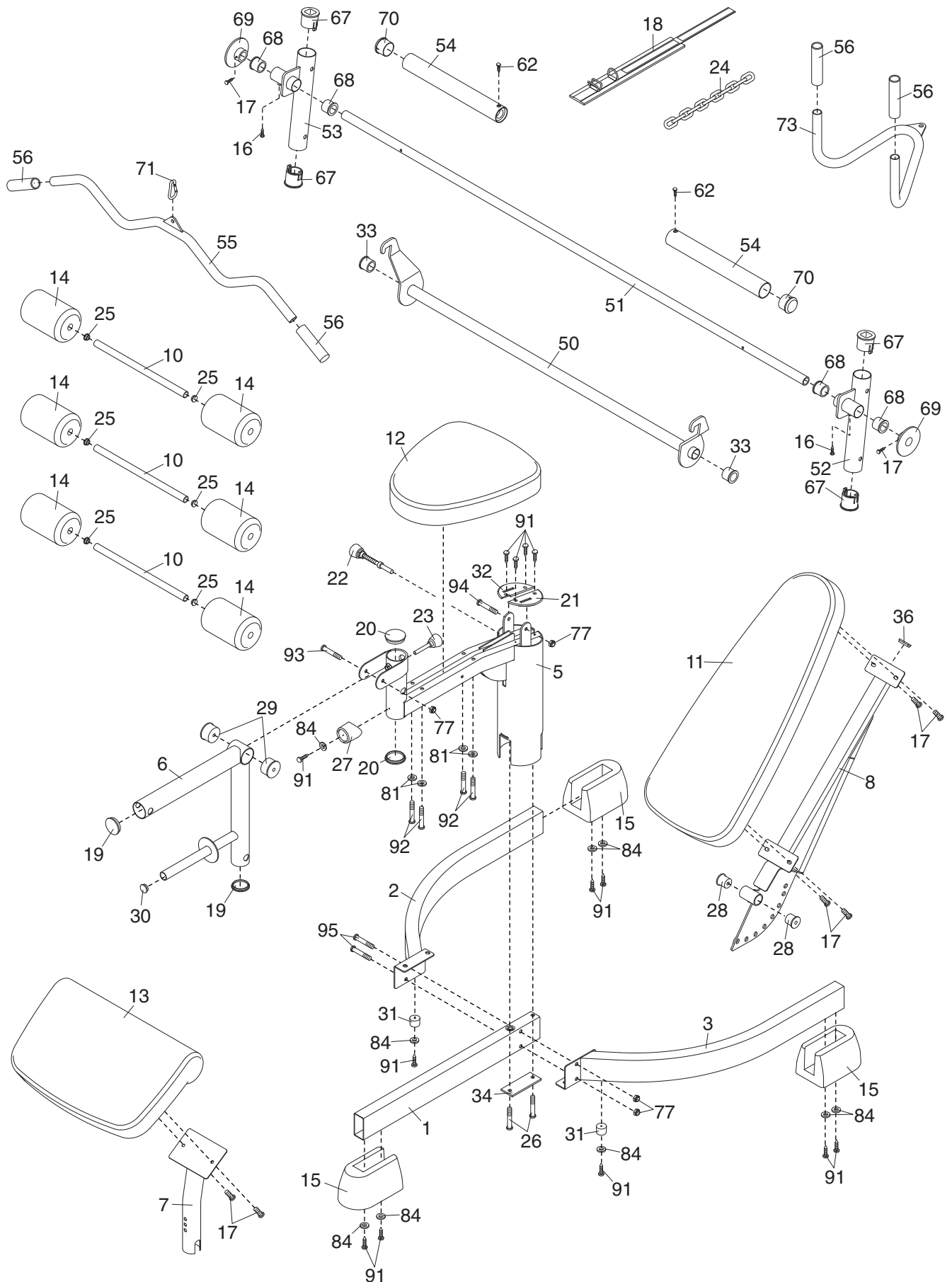

EXPLODED DRAWING B—Model No. 831.15629.0

R0905A

