

EXPLODED DRAWING—Model No. 831.15715.0

R0707A

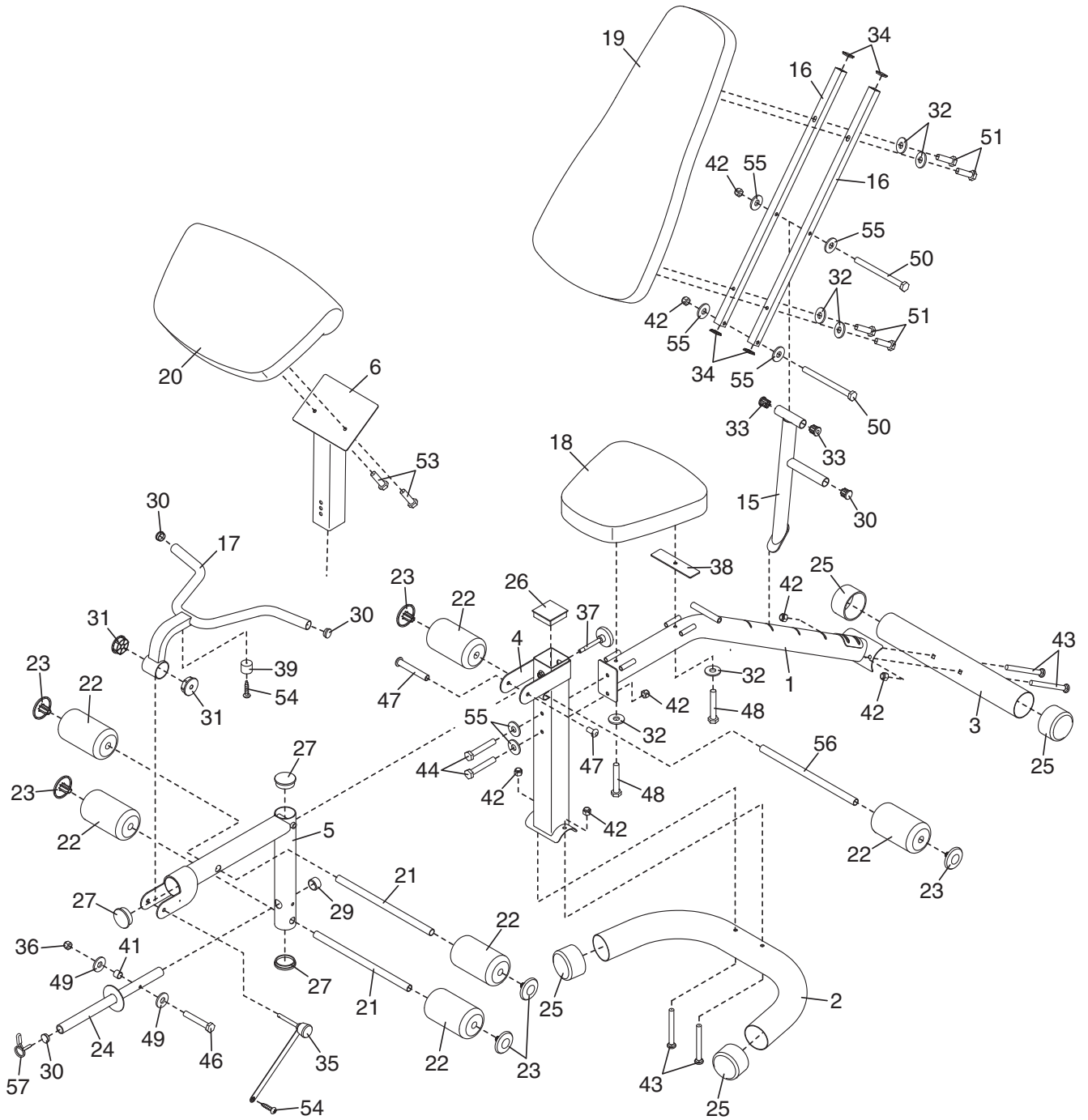

EXPLODED DRAWING—Model No. 831.15715.0

R0707A

