

EXPLODED DRAWING A

Model No. 831.15962.0 R1115A

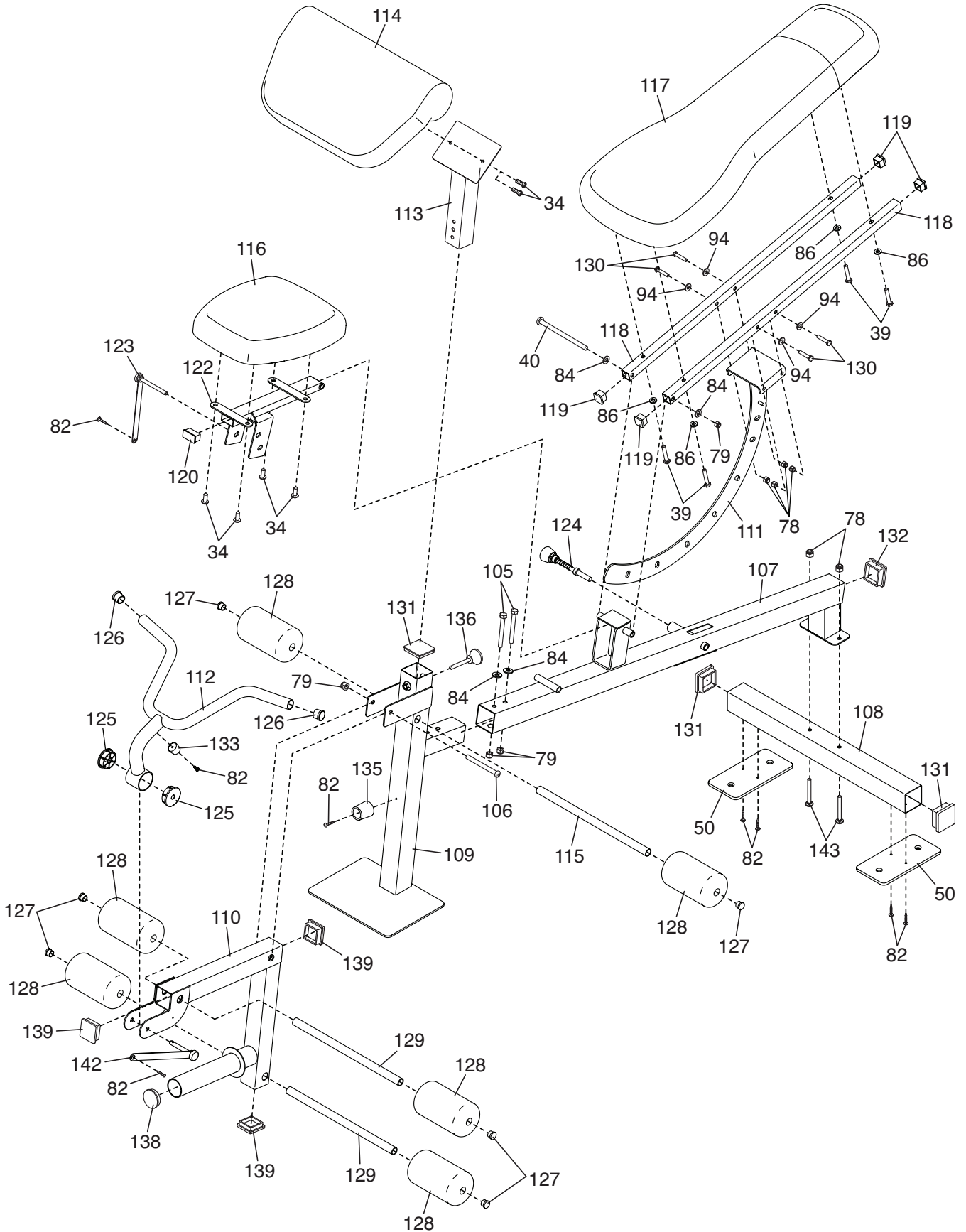

EXPLODED DRAWING B

Model No. 831.15962.0 R1115A

