

EXPLODED DRAWING A—Model No. NTEX4196.1

R1006A

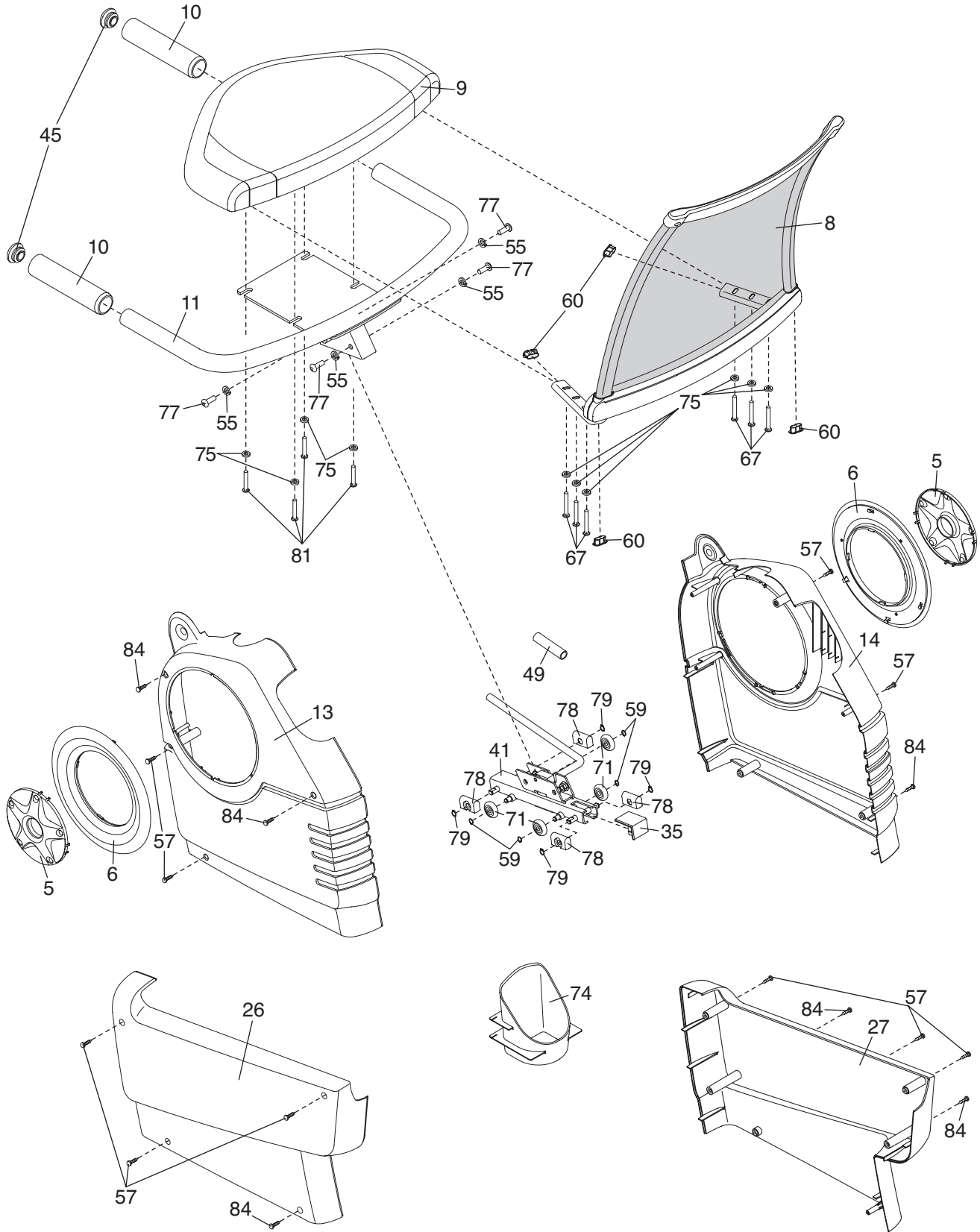

EXPLODED DRAWING B—Model No. NTEX4196.1

R1006A

