

# EXPLODED DRAWING A—Model No. NTEX3107.0

R0109A

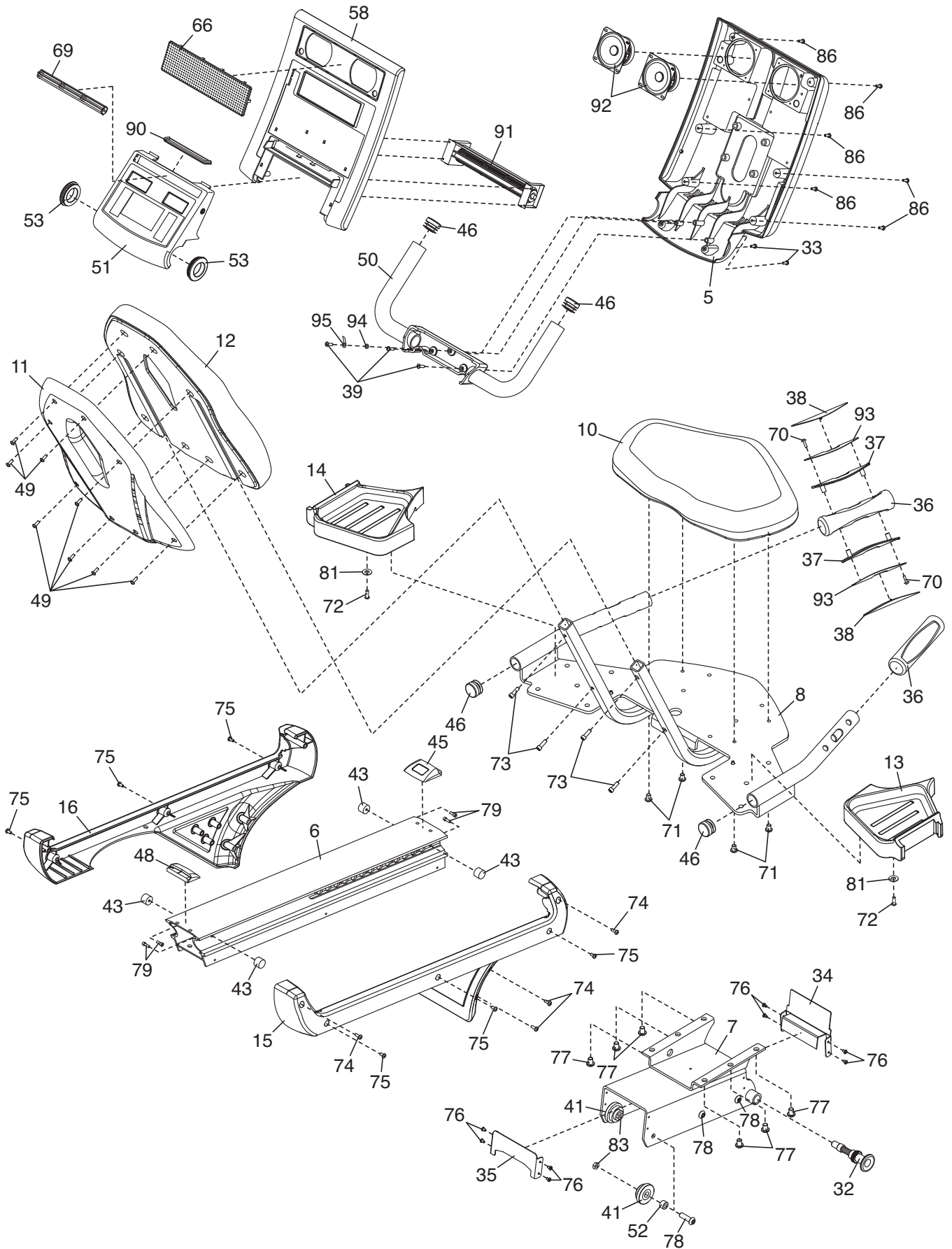

# EXPLODED DRAWING B—Model No. NTEX3107.0

R0109A

