

EXPLODED DRAWING A

Model No. 831.21923.1 R0714A

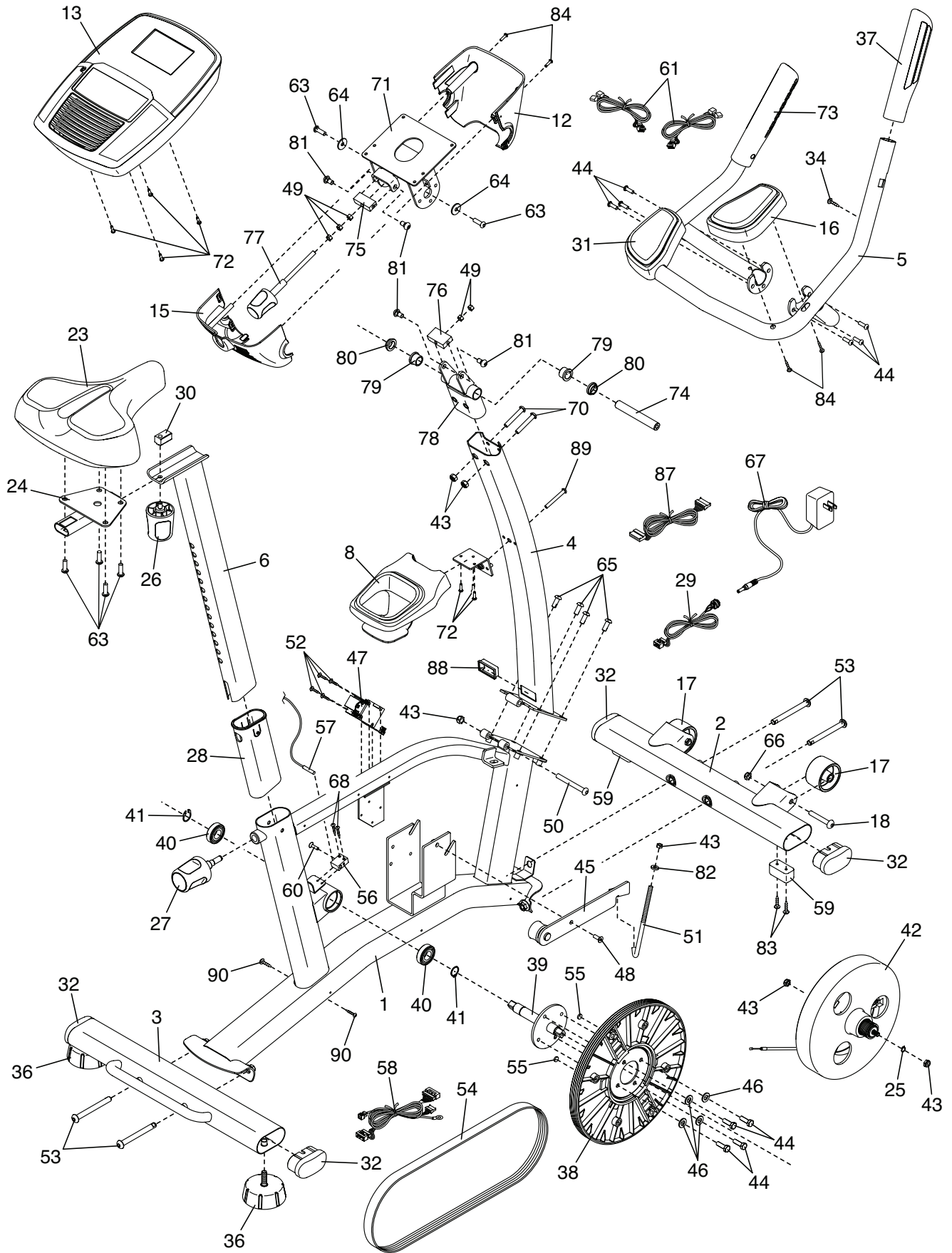

EXPLODED DRAWING B

Model No. 831.21923.1 R0714A

