

EXPLODED DRAWING A

Model No. 21923.3 R0418A

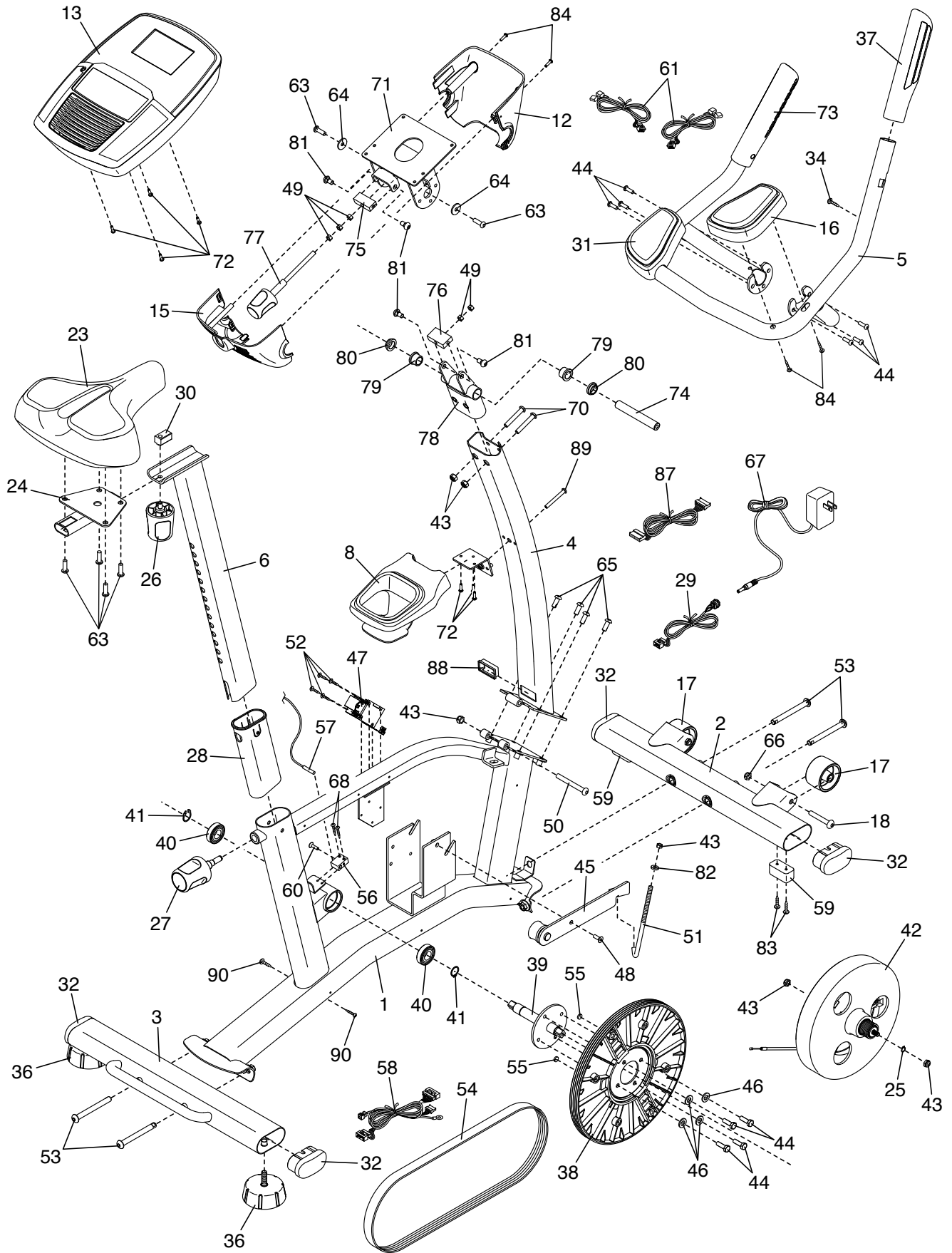

EXPLODED DRAWING B

Model No. 21923.3 R0418A

