

EXPLODED DRAWING A

Model No. 831.21952.6 R0112A

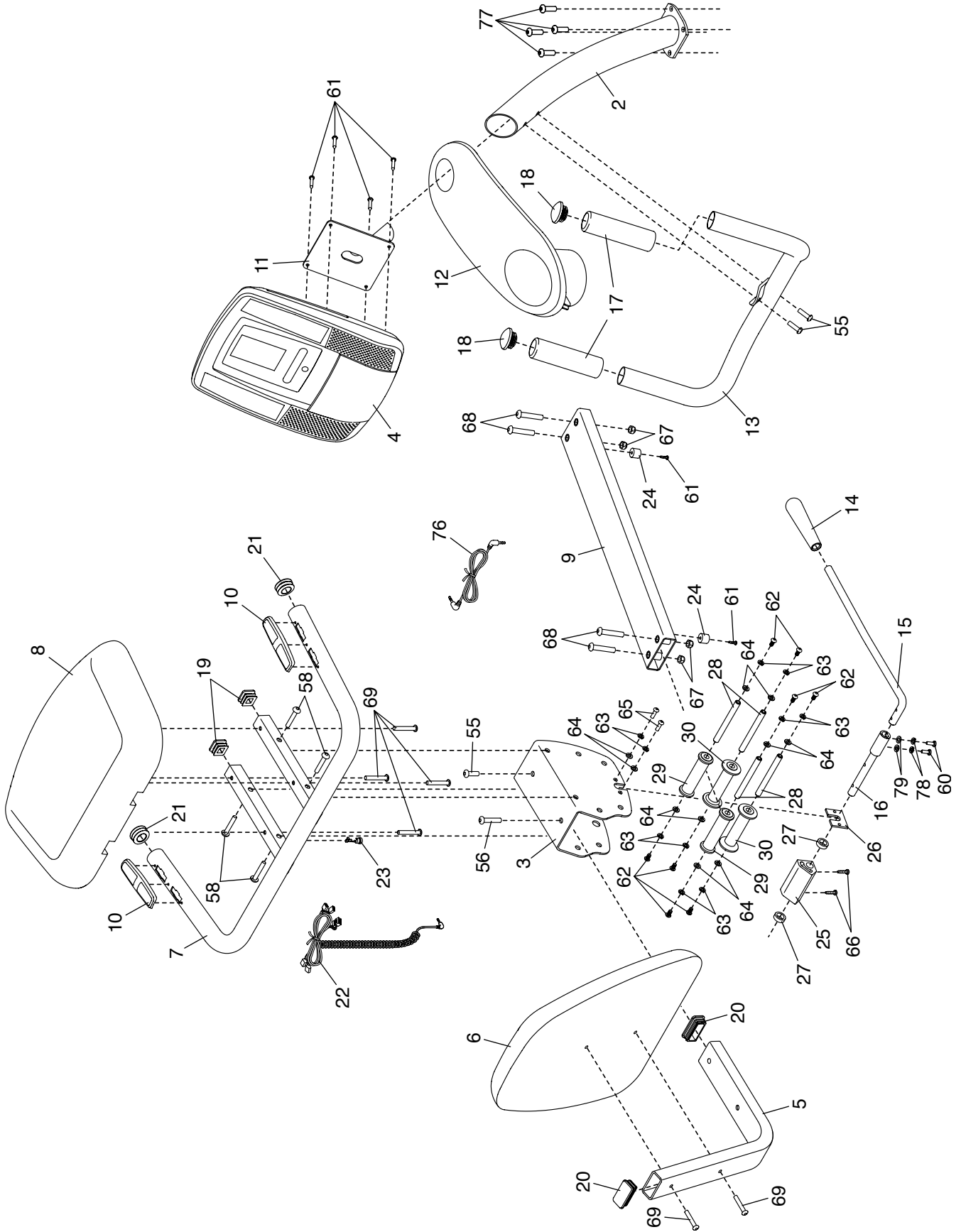

EXPLODED DRAWING B

Model No. 831.21952.6 R0112A

