

EXPLODED DRAWING A

Model No. 831.21952.7 R0512A

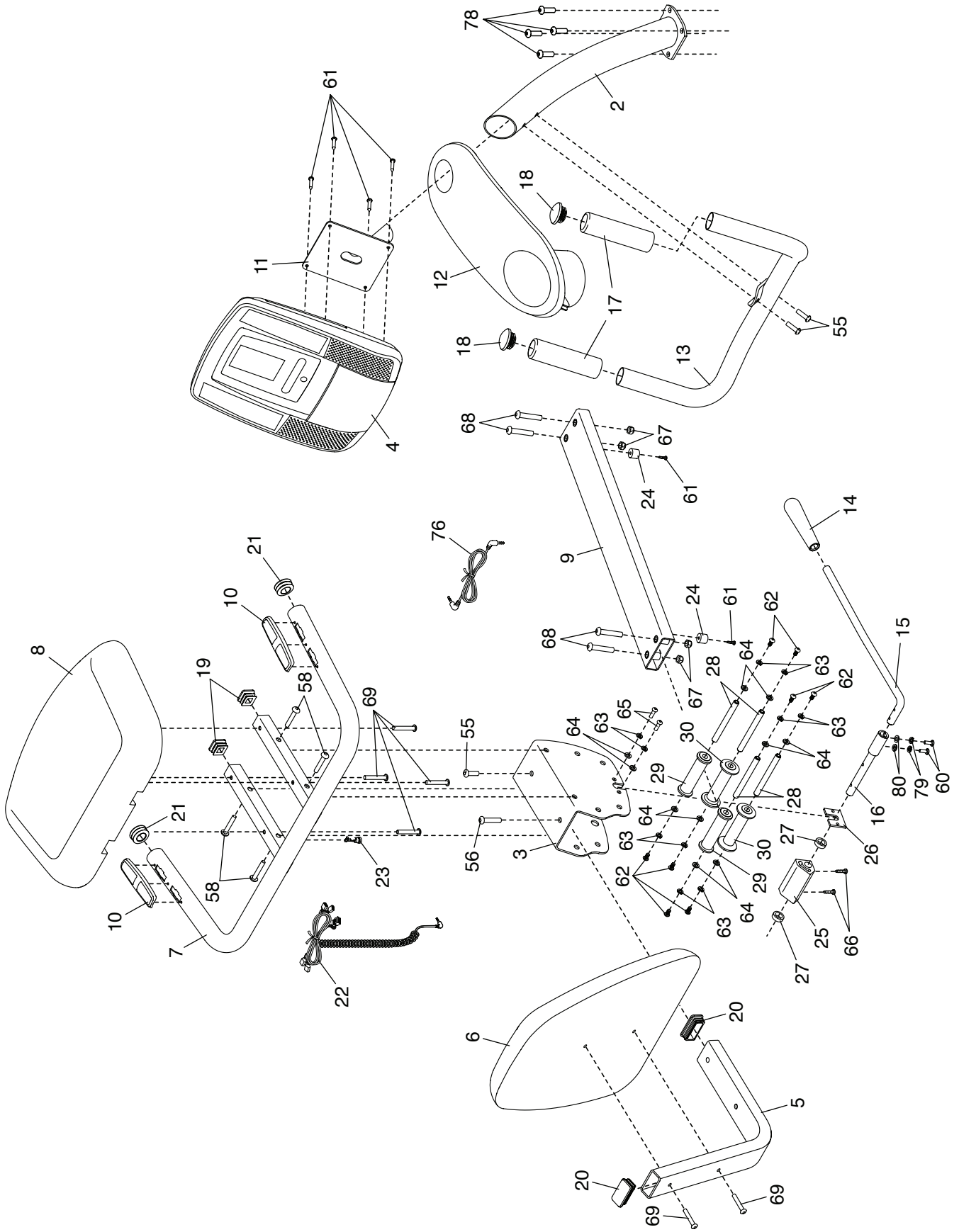

EXPLODED DRAWING B

Model No. 831.21952.7 R0512A

