

# EXPLODED DRAWING A

Model No. 831.21952.2 R0112A

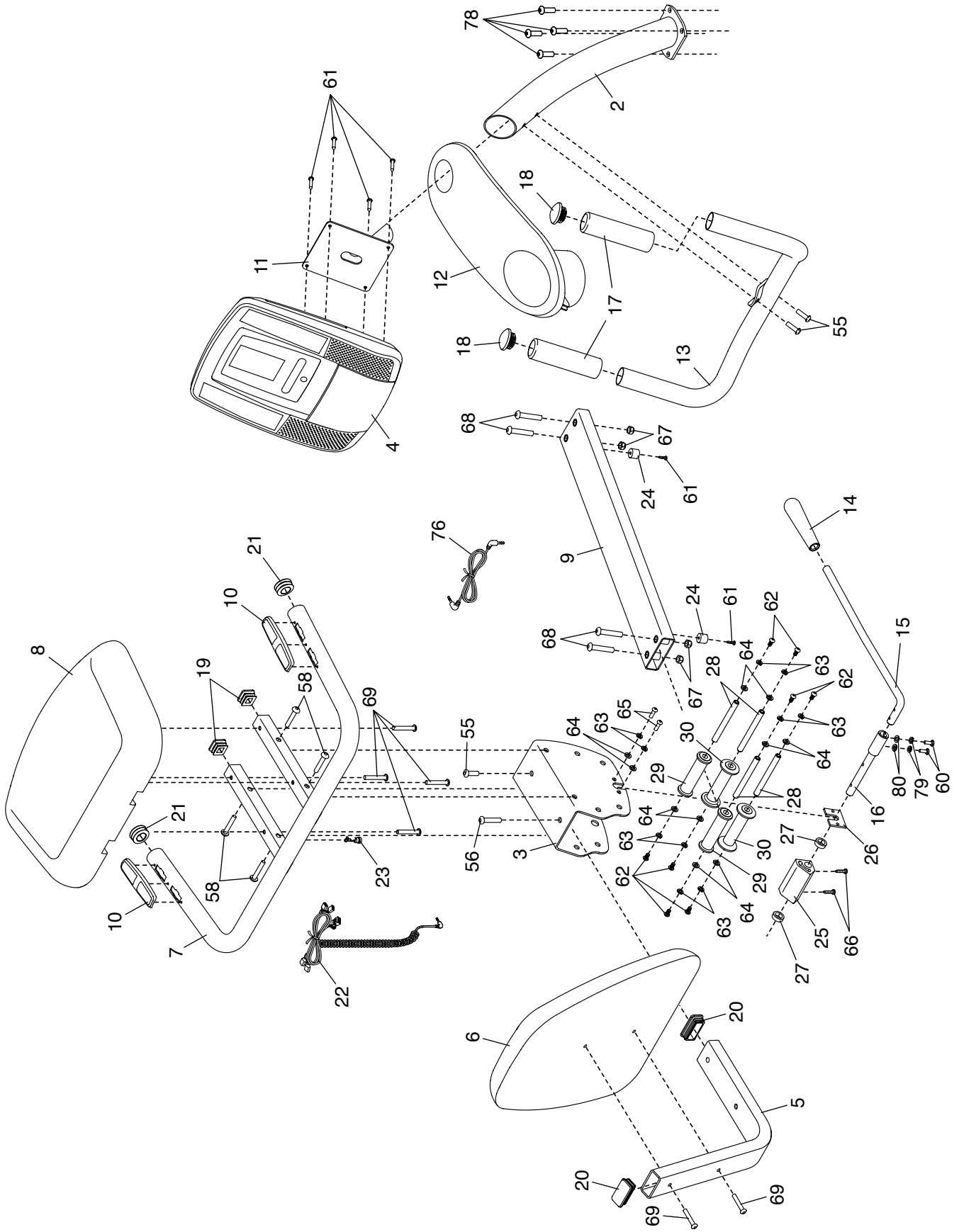

# EXPLODED DRAWING B

Model No. 831.21952.2 R0112A

