

EXPLODED DRAWING A—Model No. 831.23745.1

R0108A

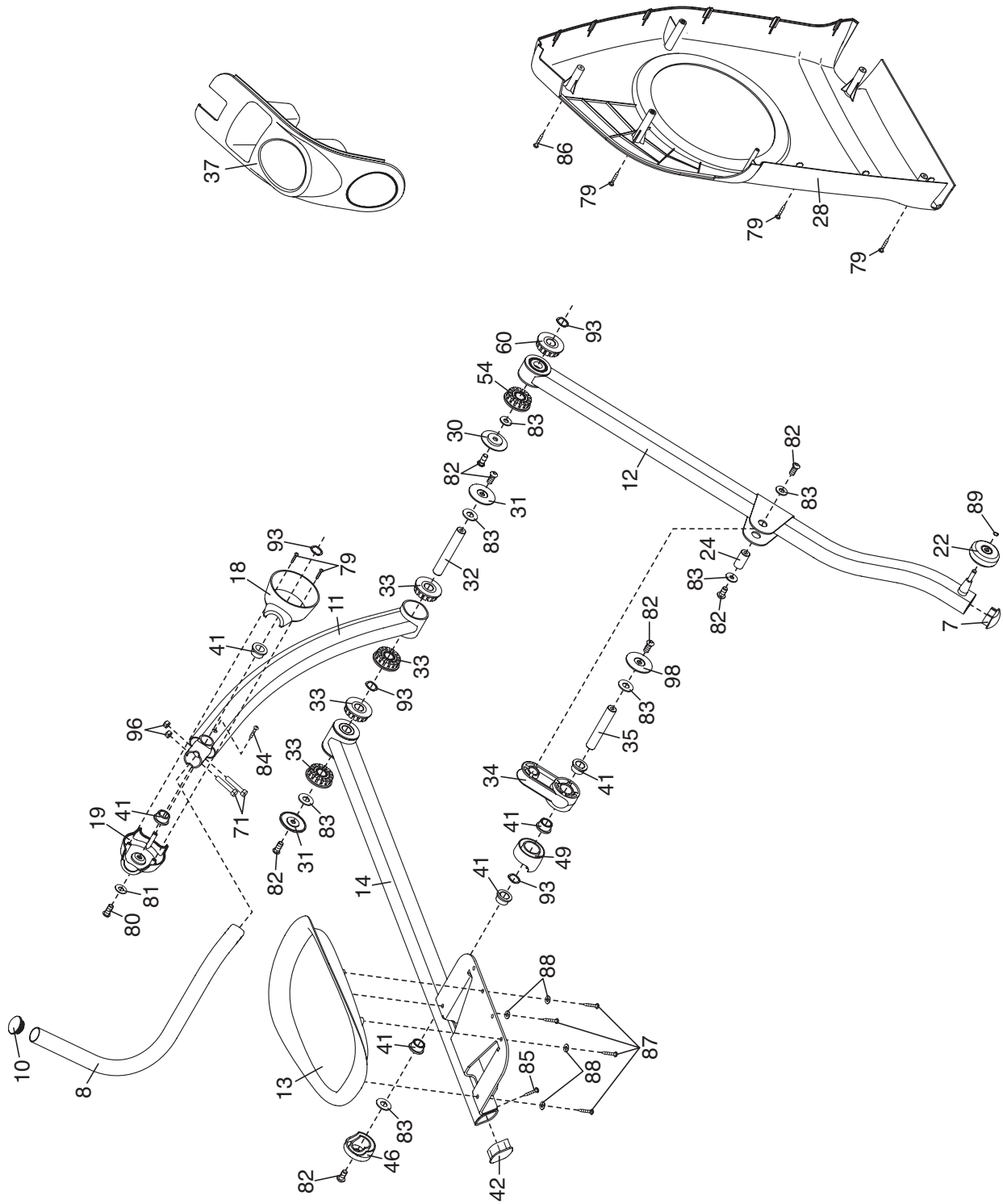

EXPLODED DRAWING B—Model No. 831.23745.1

R0108A

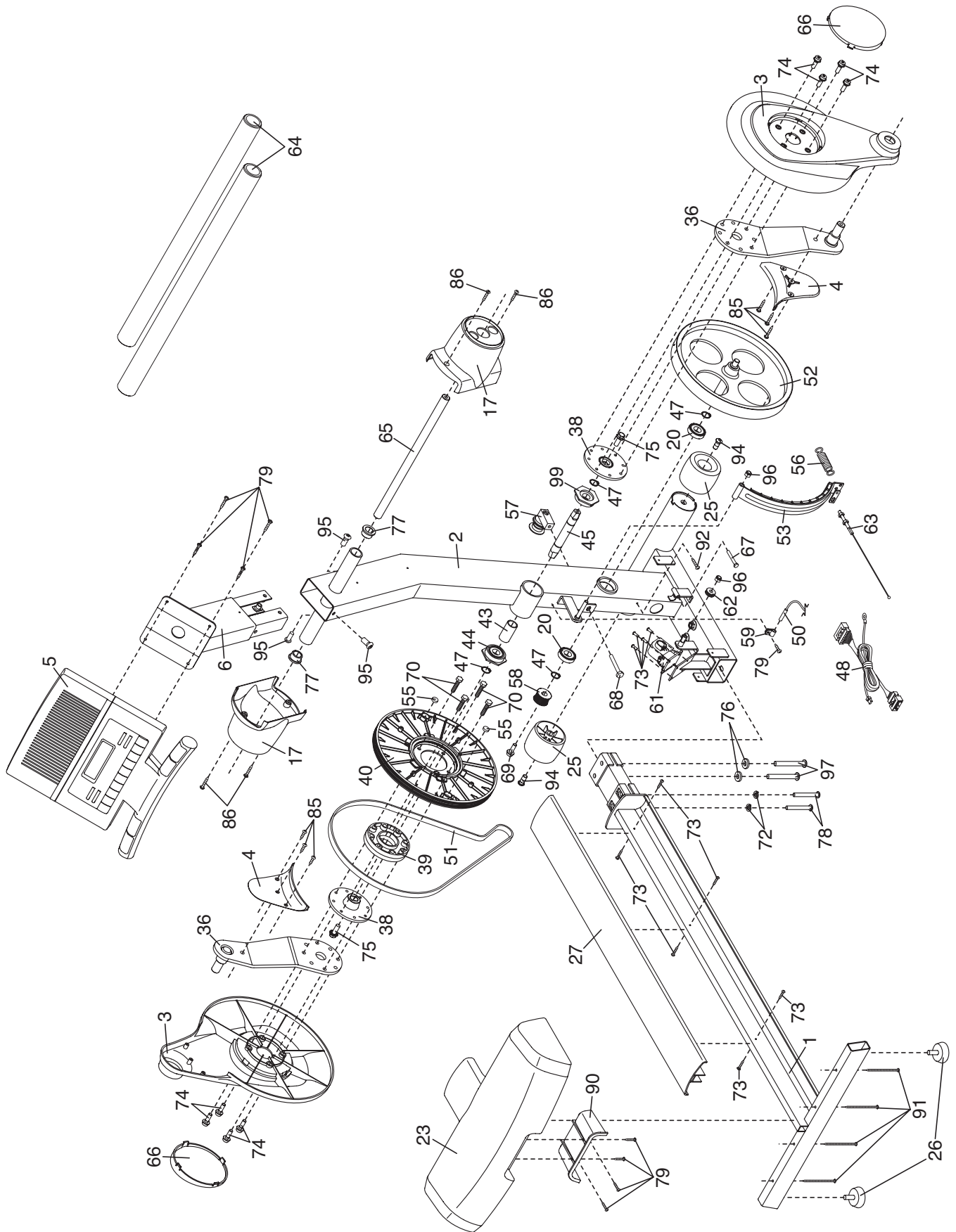

EXPLODED DRAWING C—Model No. 831.23745.1

R0108A

