

EXPLODED DRAWING A—Model No. NTEL00907.1

R0108A

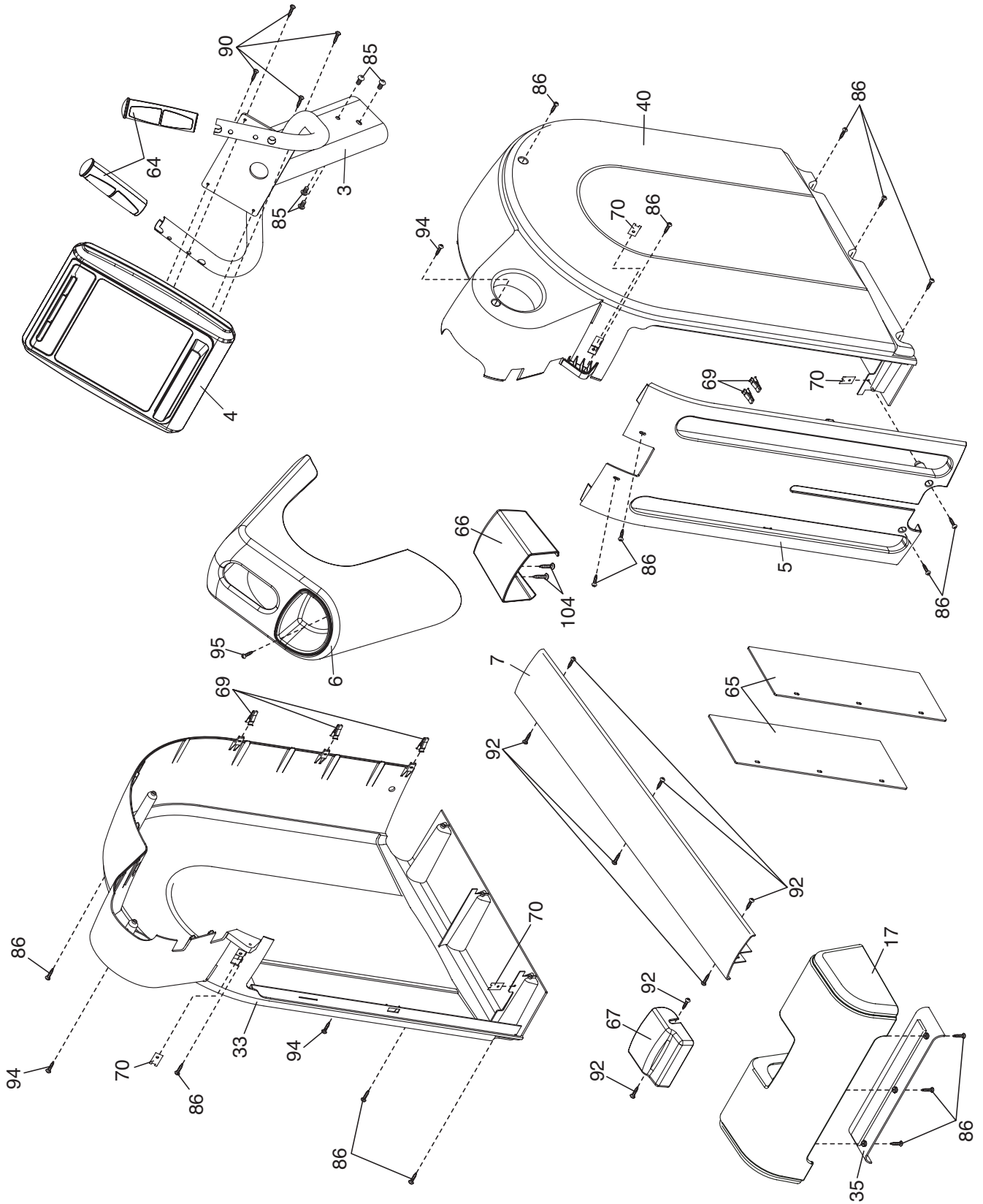

EXPLODED DRAWING B—Model No. NTEL00907.1

R0108A

