

EXPLODED DRAWING A—Model No. NTEL00907.2

R0408A

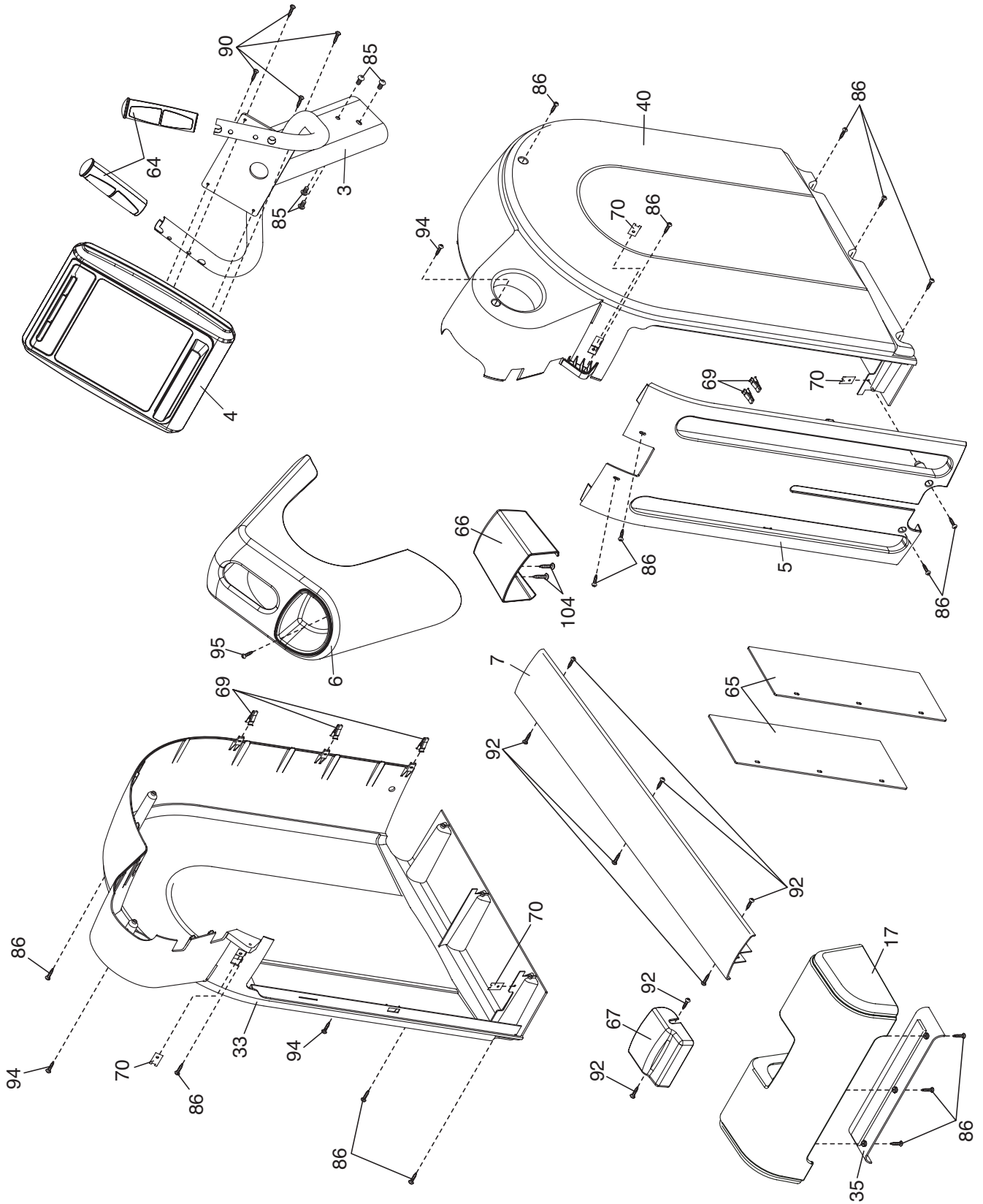

EXPLODED DRAWING B—Model No. NTEL00907.2

R0408A

