

EXPLODED DRAWING A

Model No. NTEL07808.3 R0111A

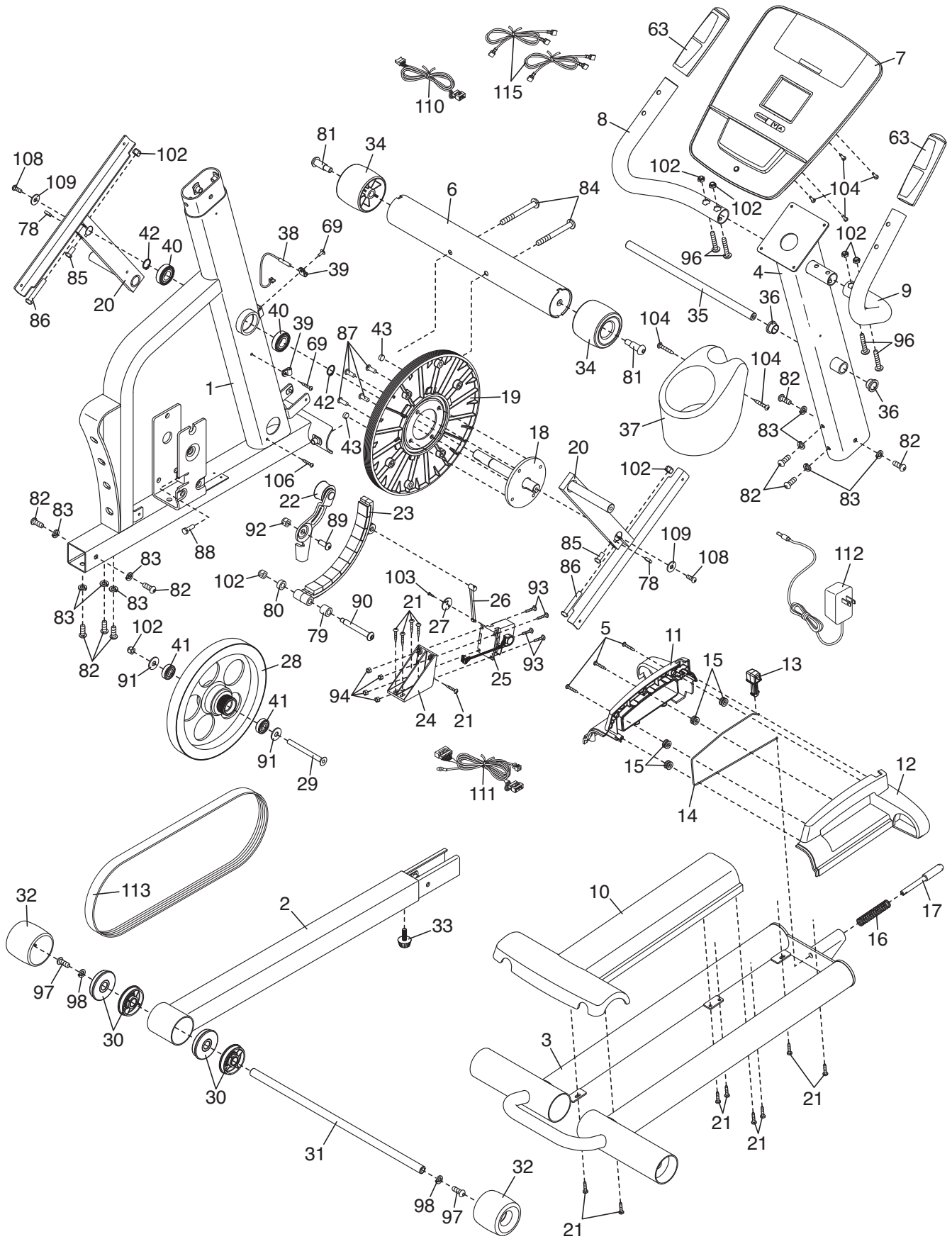

EXPLODED DRAWING B

Model No. NTEL07808.3 R0111A

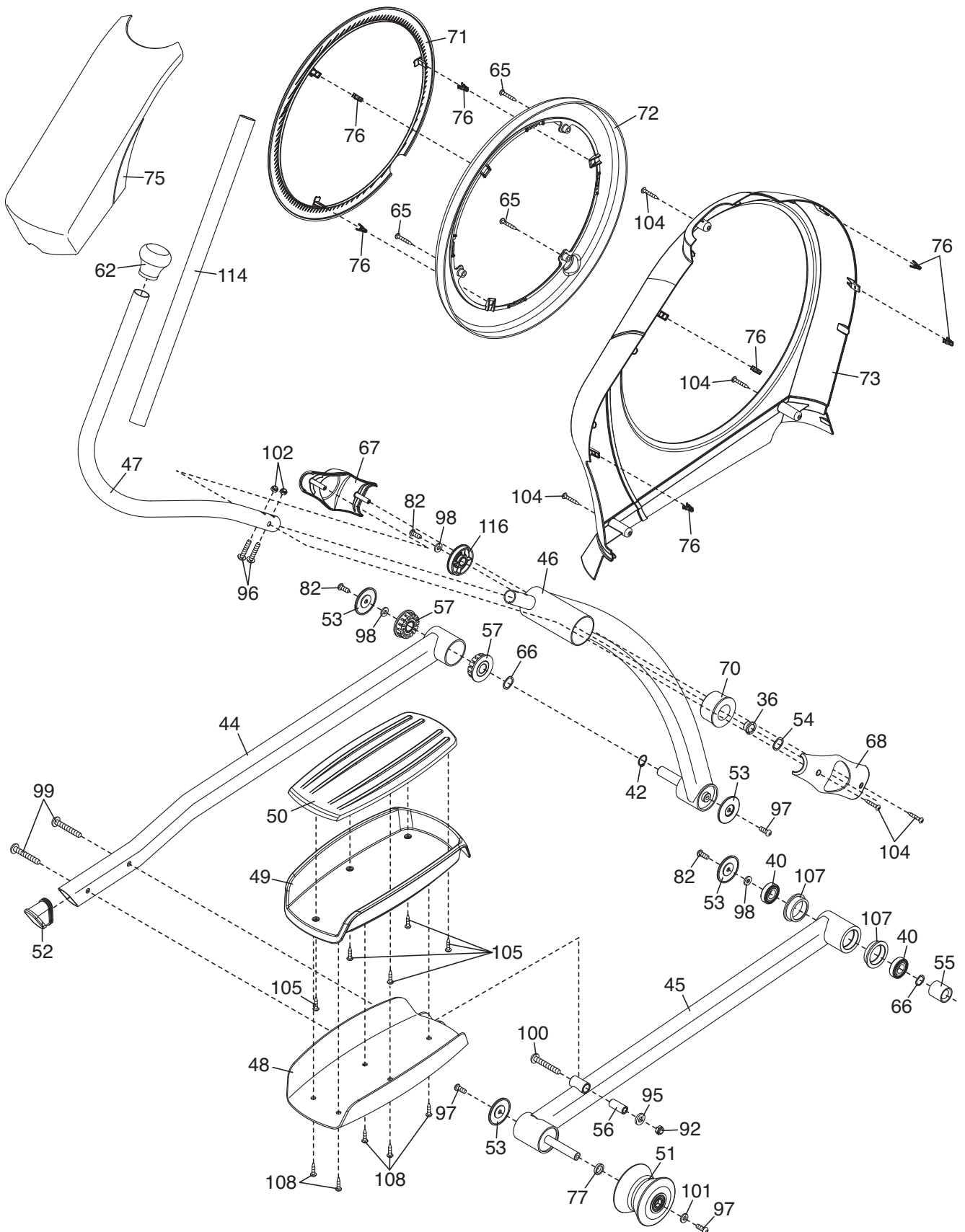

EXPLODED DRAWING C

Model No. NTEL07808.3 R0111A

