

# EXPLODED DRAWING A

Model No. NTEL07808.5 R1210A

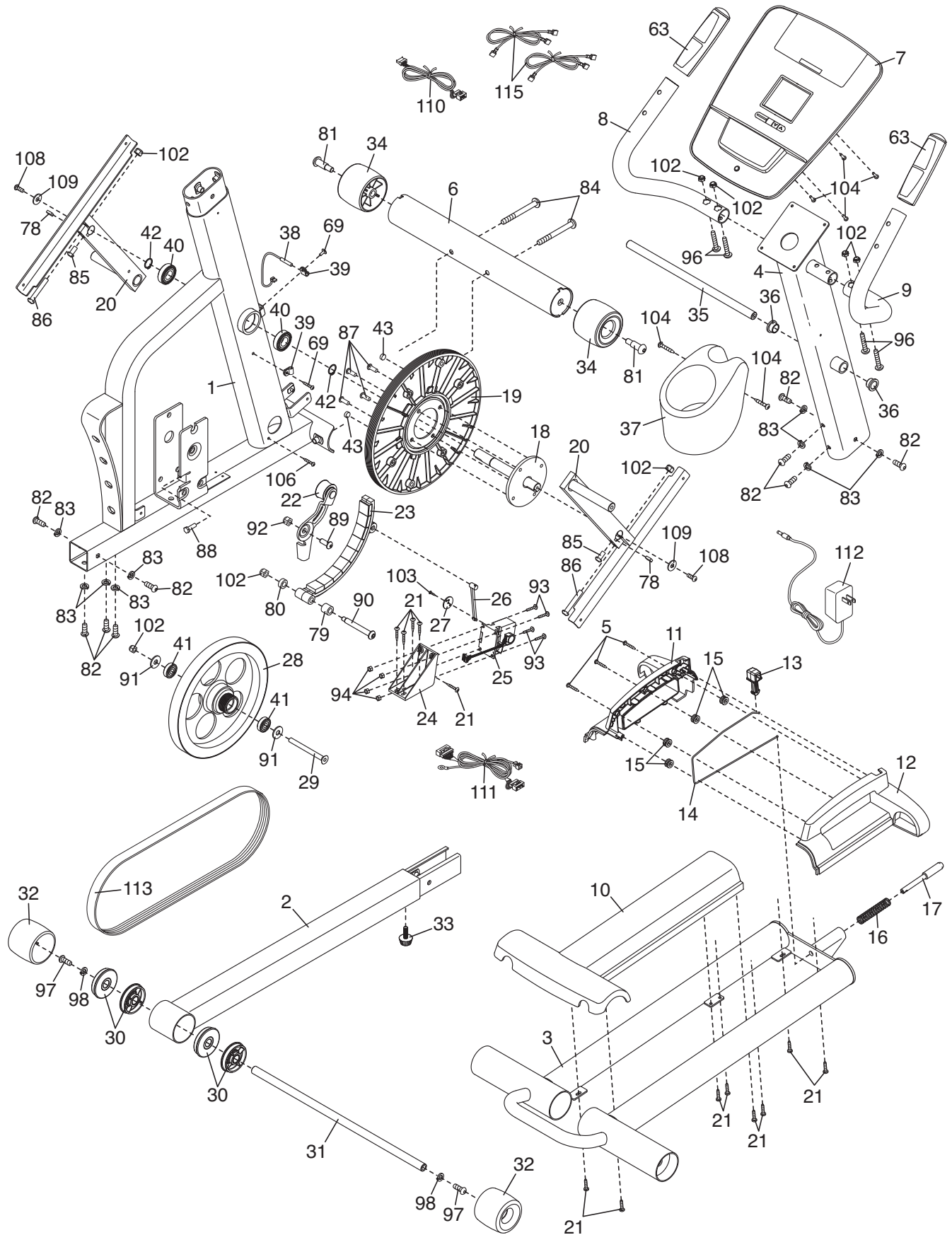

# EXPLODED DRAWING B

Model No. NTEL07808.5 R1210A

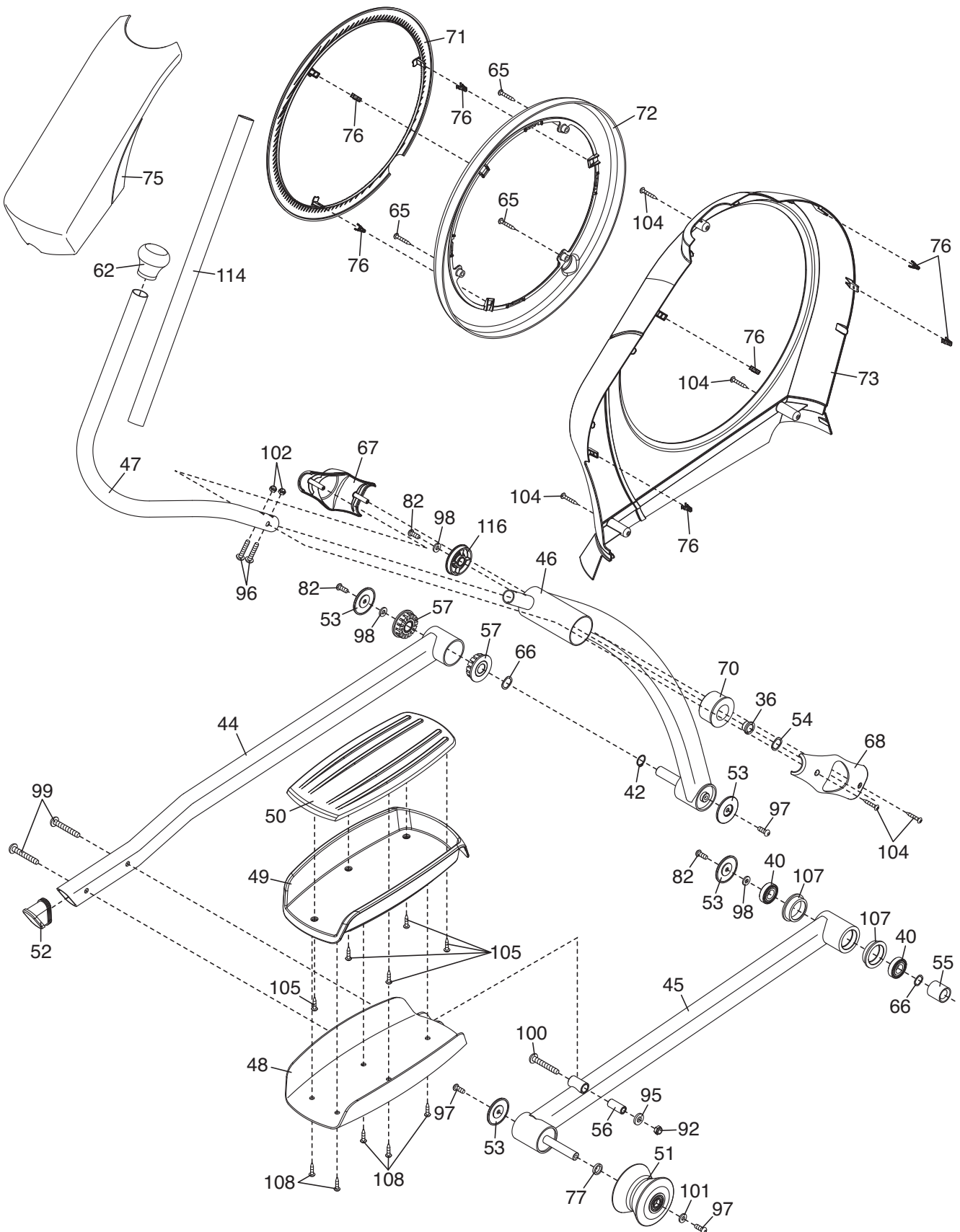

# EXPLODED DRAWING C

Model No. NTEL07808.5 R1210A

