

EXPLODED DRAWING A

Model No. 831.23887.0 R0414A

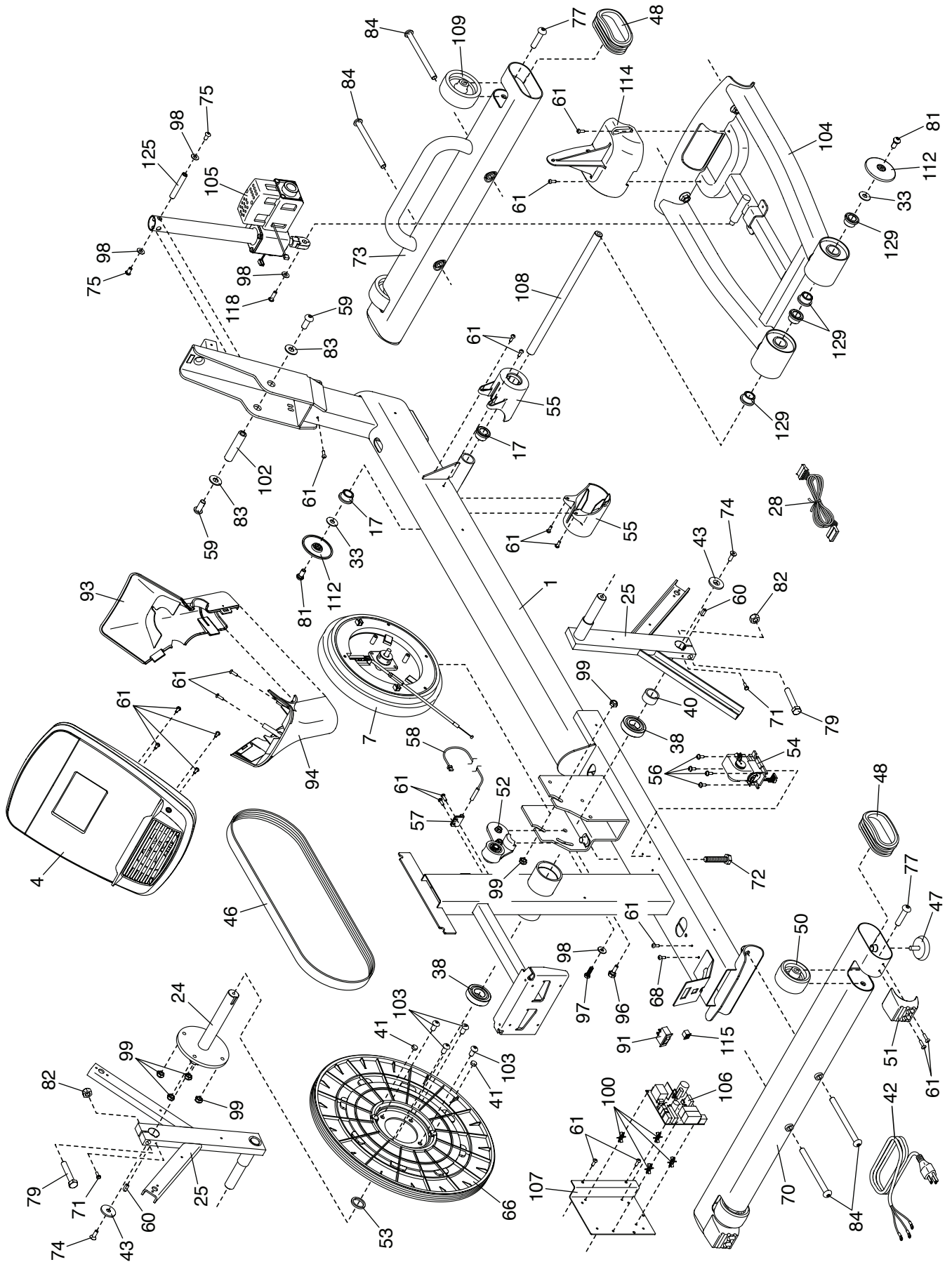

EXPLODED DRAWING B

Model No. 831.23887.0 R0414A

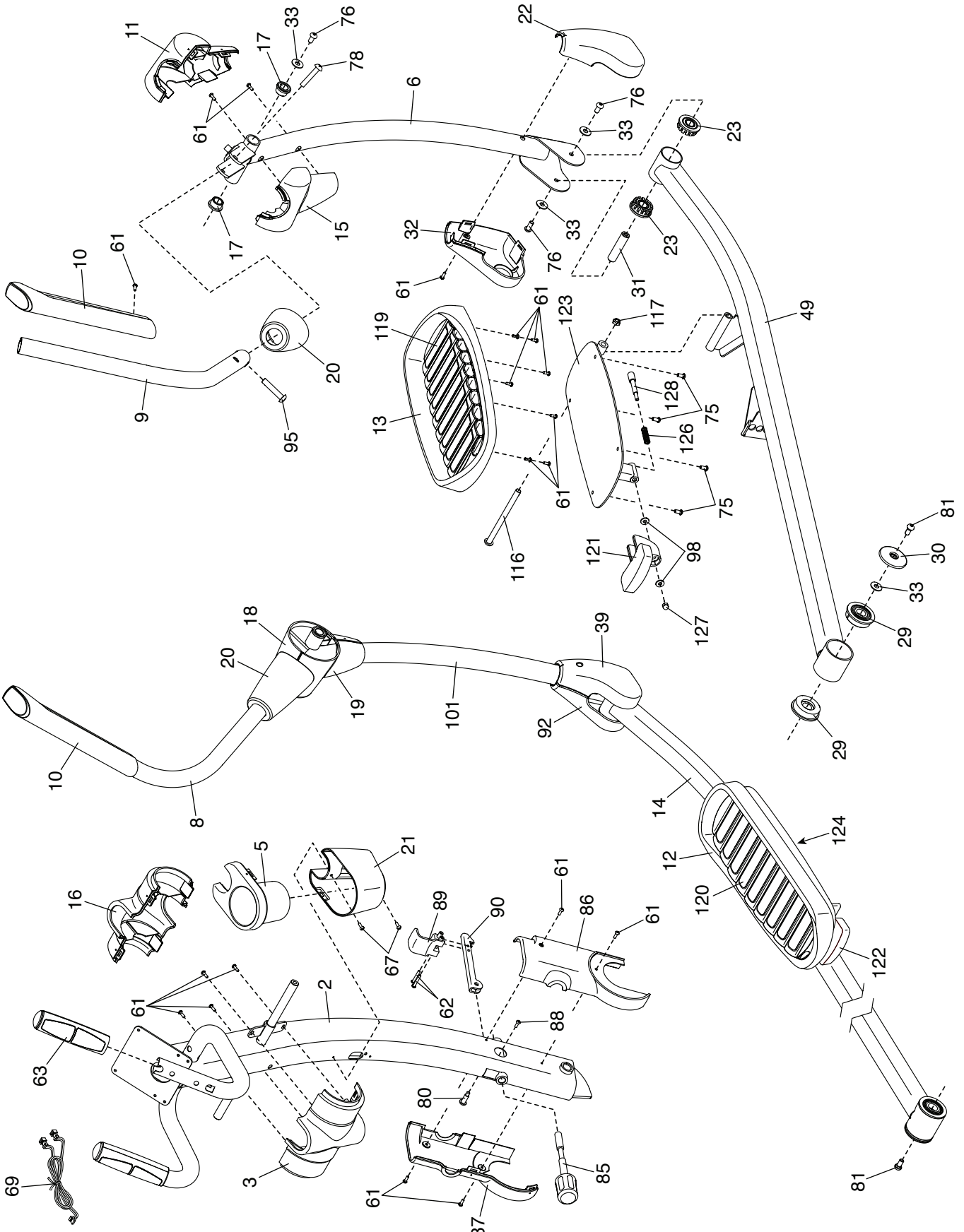

EXPLODED DRAWING C

Model No. 831.23887.0 R0414A

