

EXPLODED DRAWING A

Model No. 23900.3 R0516A

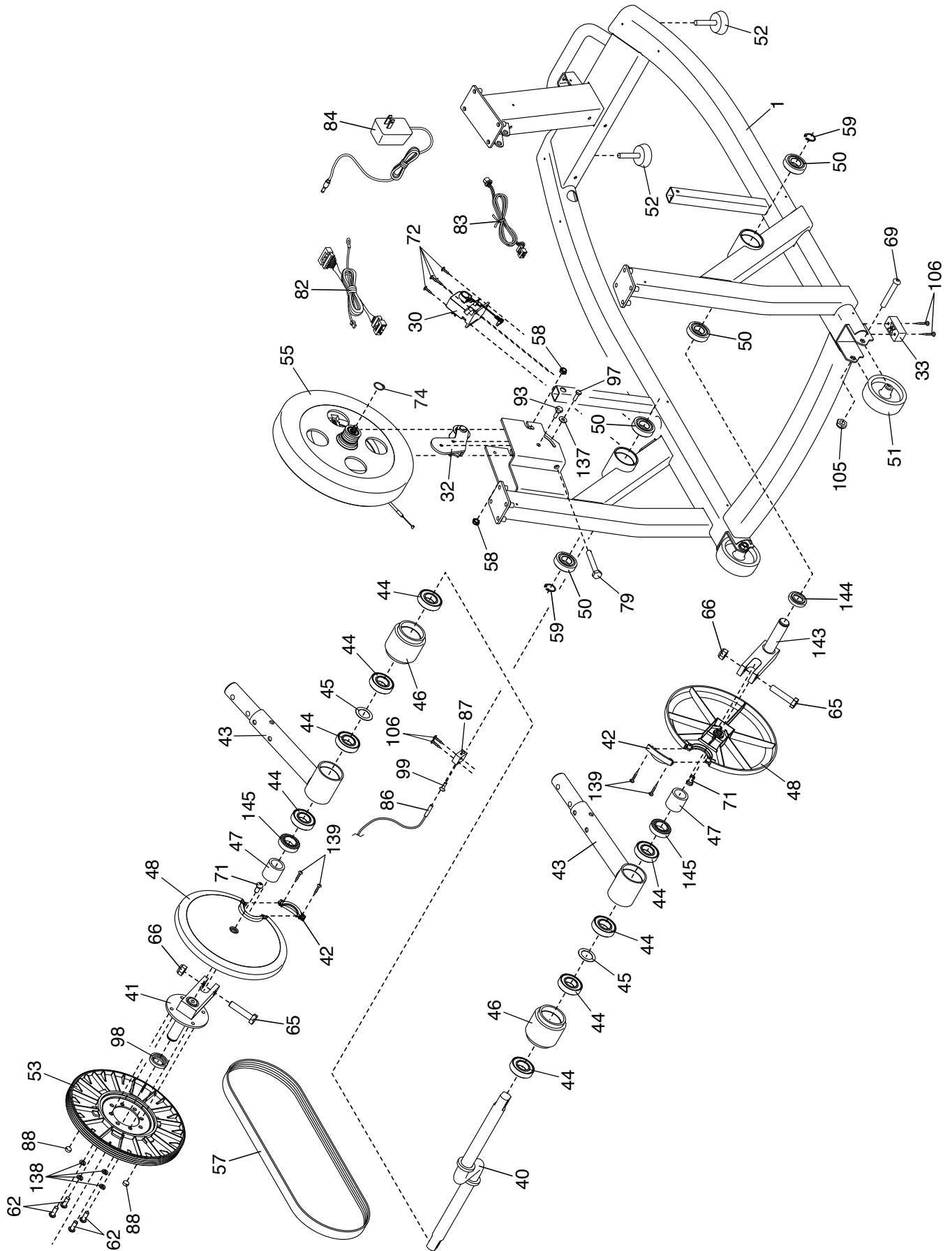

EXPLODED DRAWING B

Model No. 23900.3 R0516A

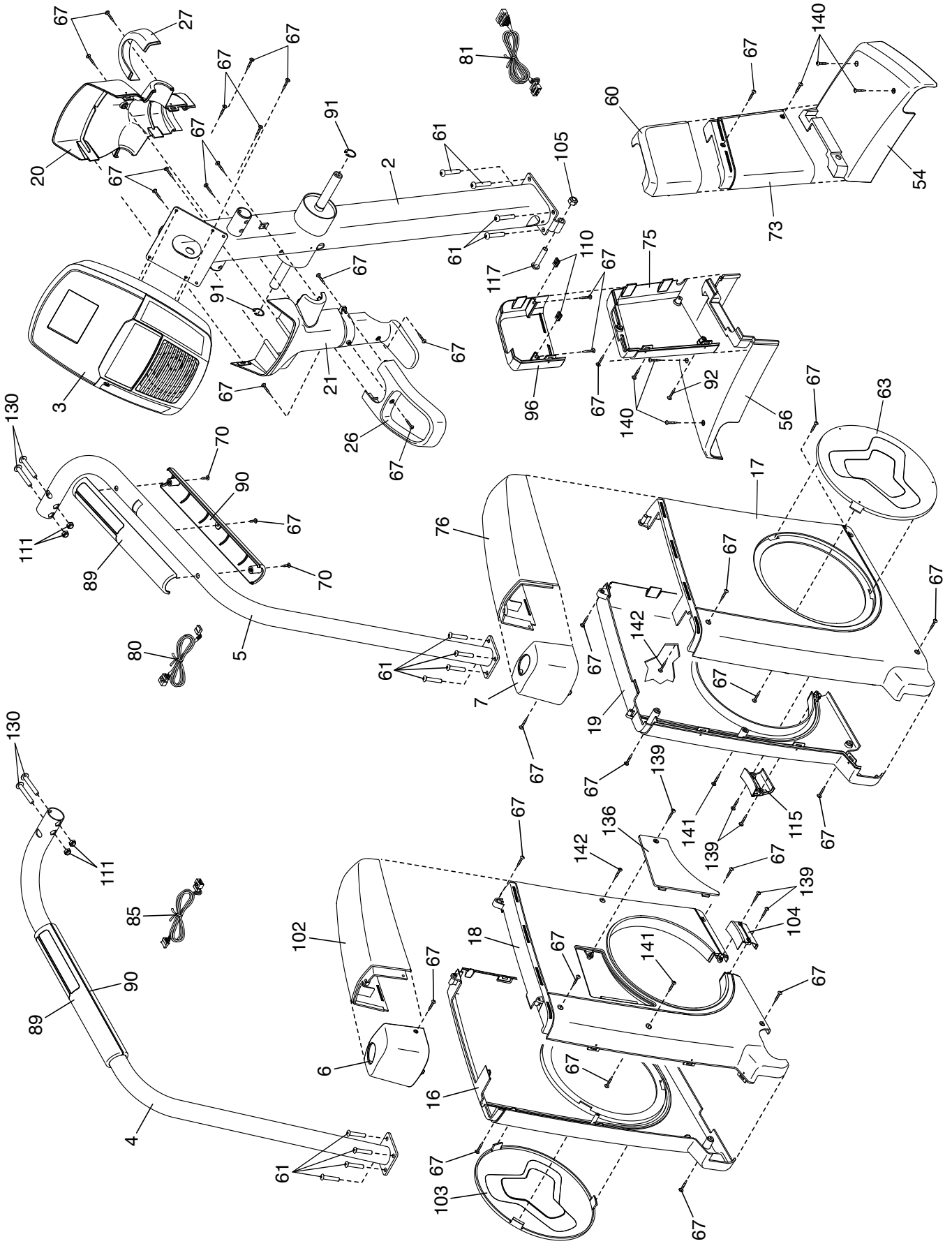

EXPLODED DRAWING C

Model No. 23900.3 R0516A

