

EXPLODED DRAWING A

Model No. 23906.1 R0817A

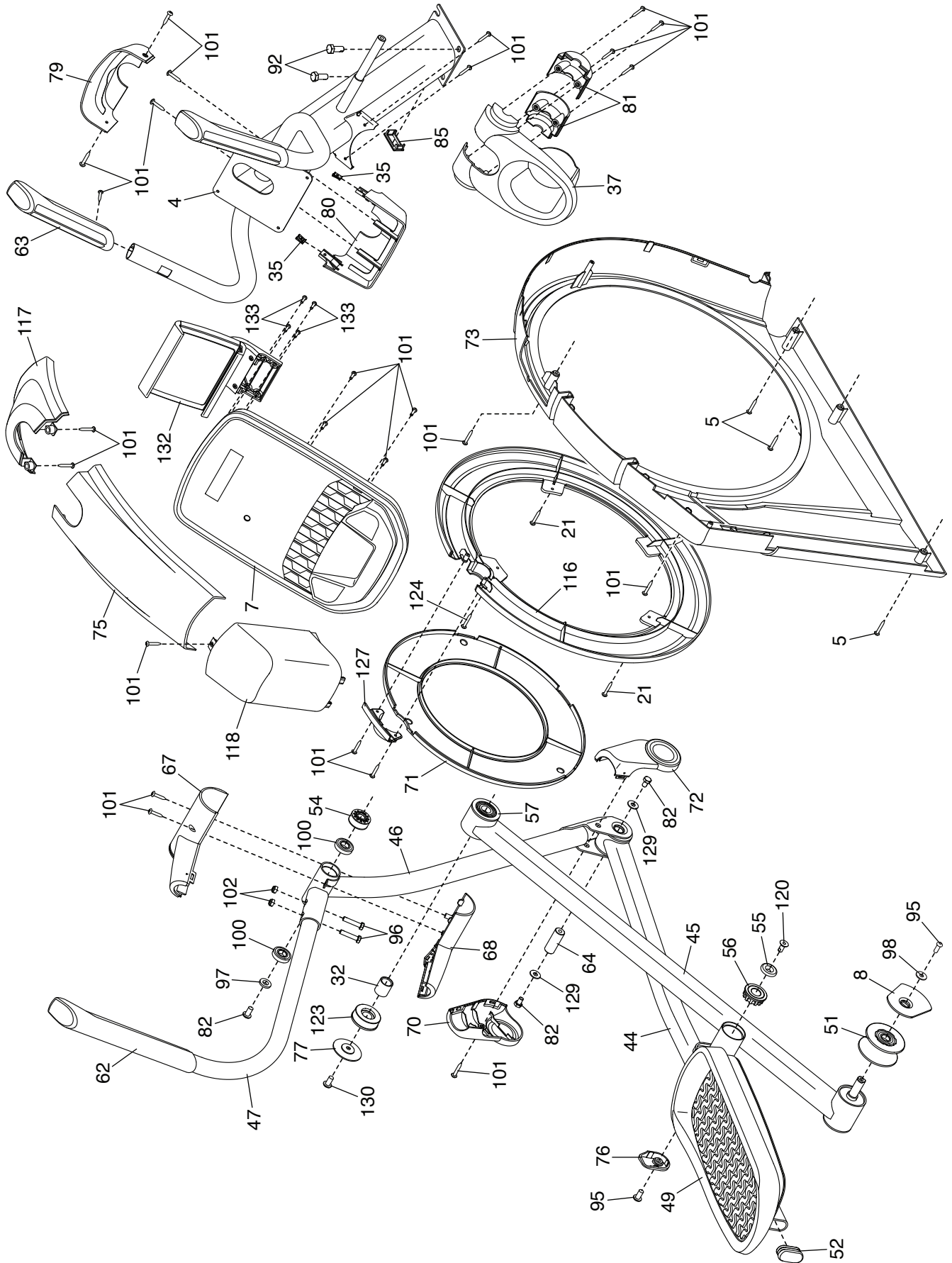

EXPLODED DRAWING B

Model No. 23906.1 R0817A

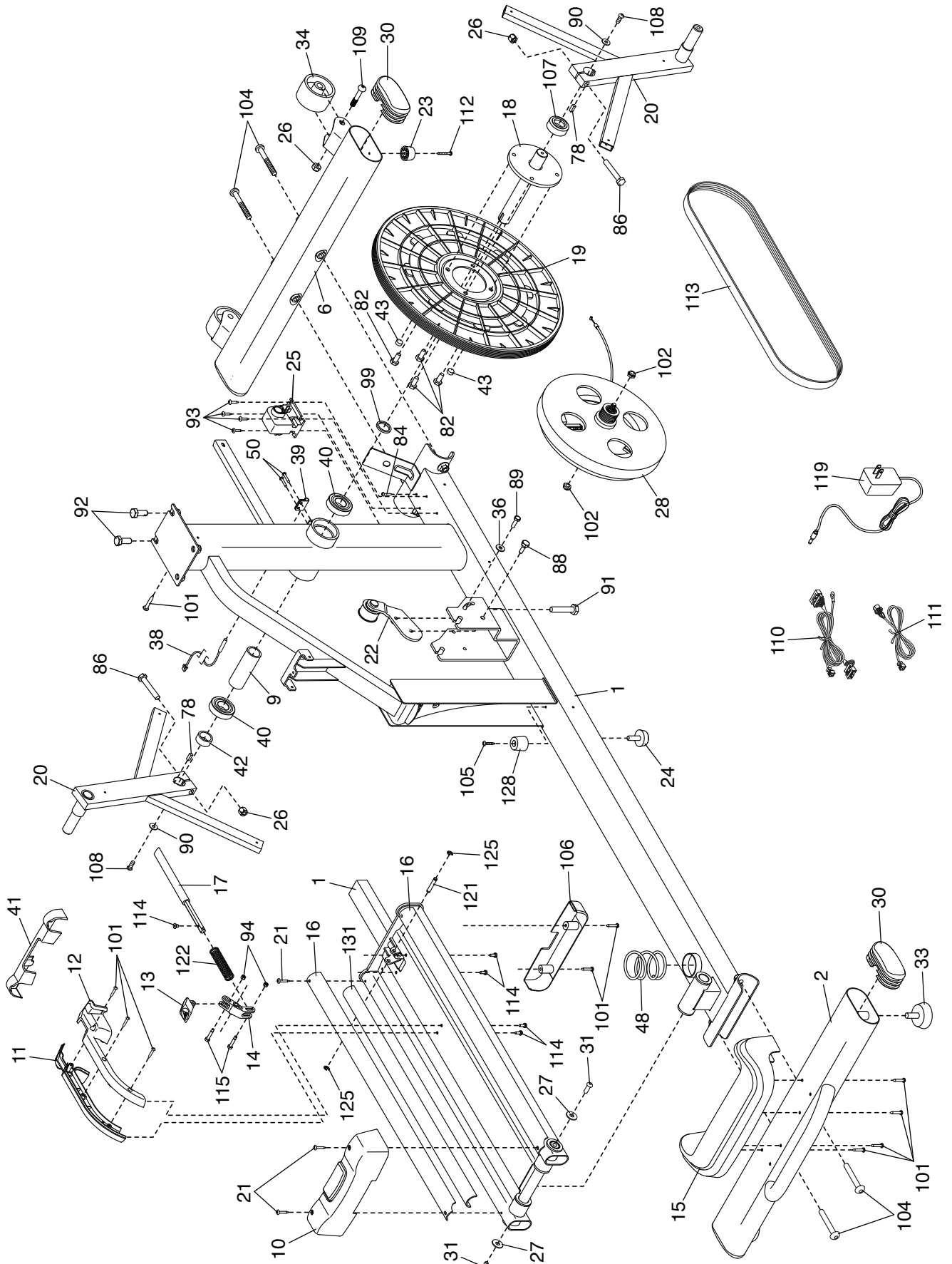

EXPLODED DRAWING C

Model No. 23906.1 R0817A

