

EXPLODED DRAWING A

Model No. 23909.1 R0116A

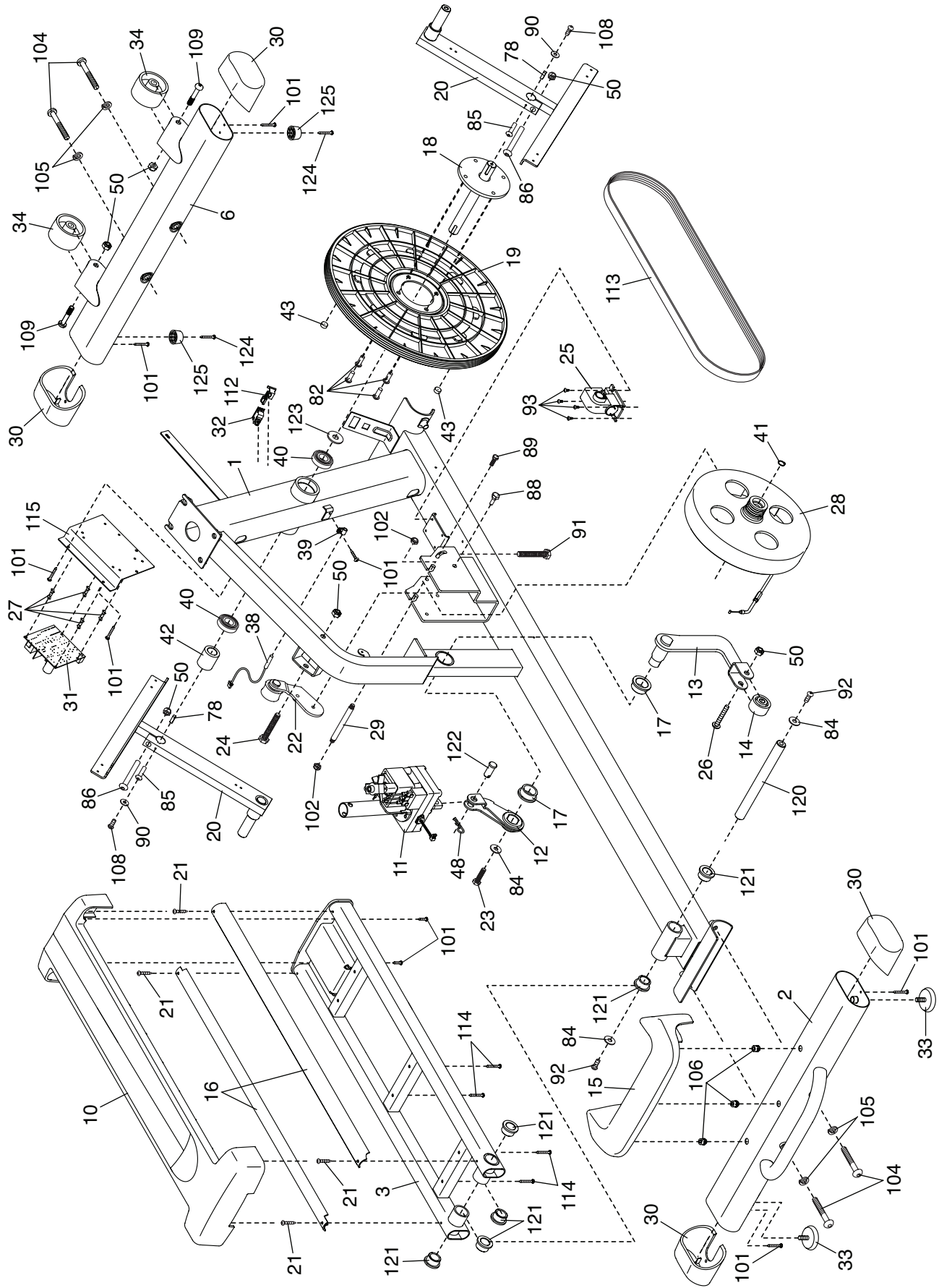

EXPLODED DRAWING B

Model No. 23909.1 R0116A

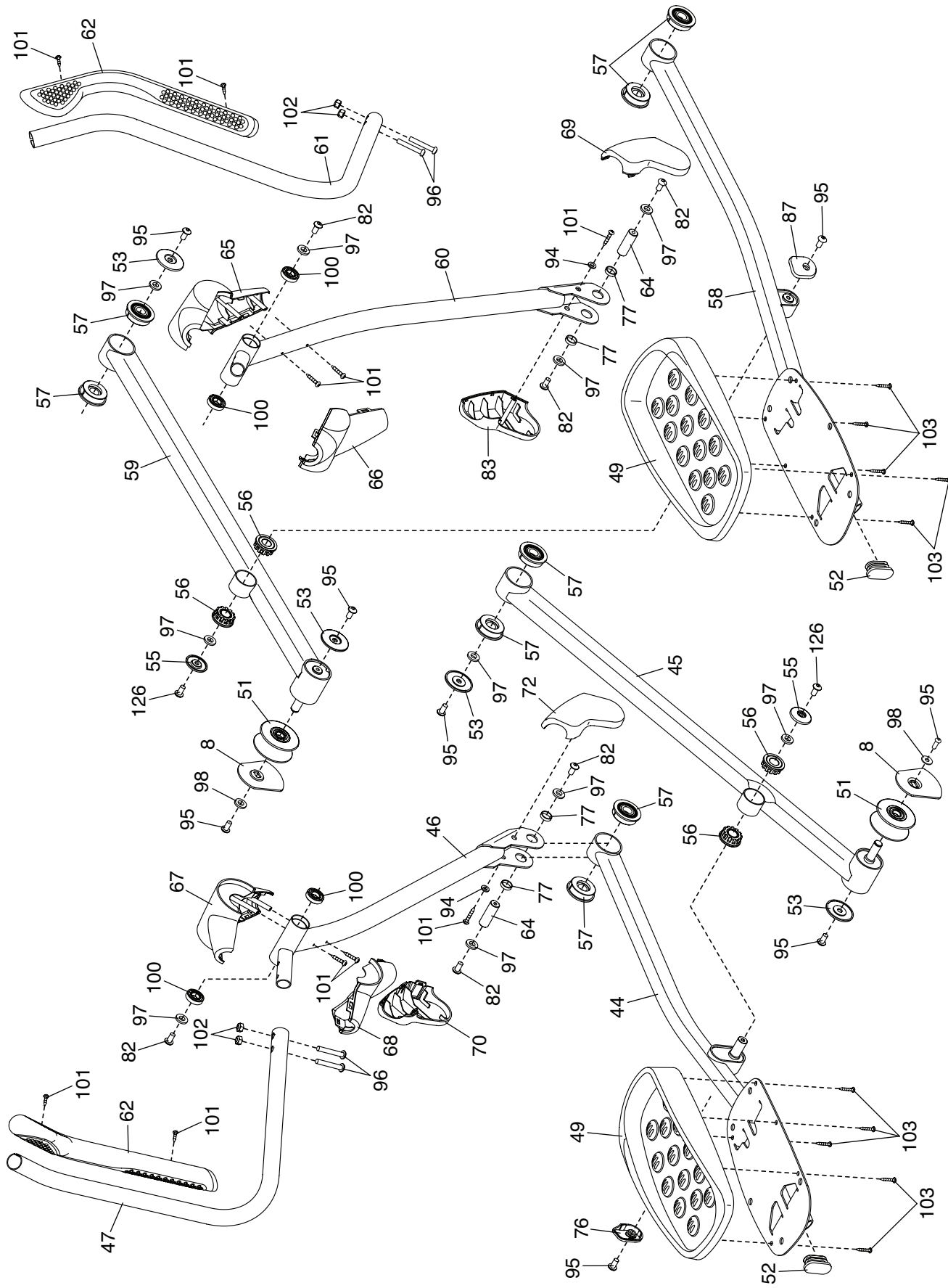

EXPLODED DRAWING C

Model No. 23909.1 R0116A

