

EXPLODED DRAWING A—Model No. 831.23912.0

R0509A

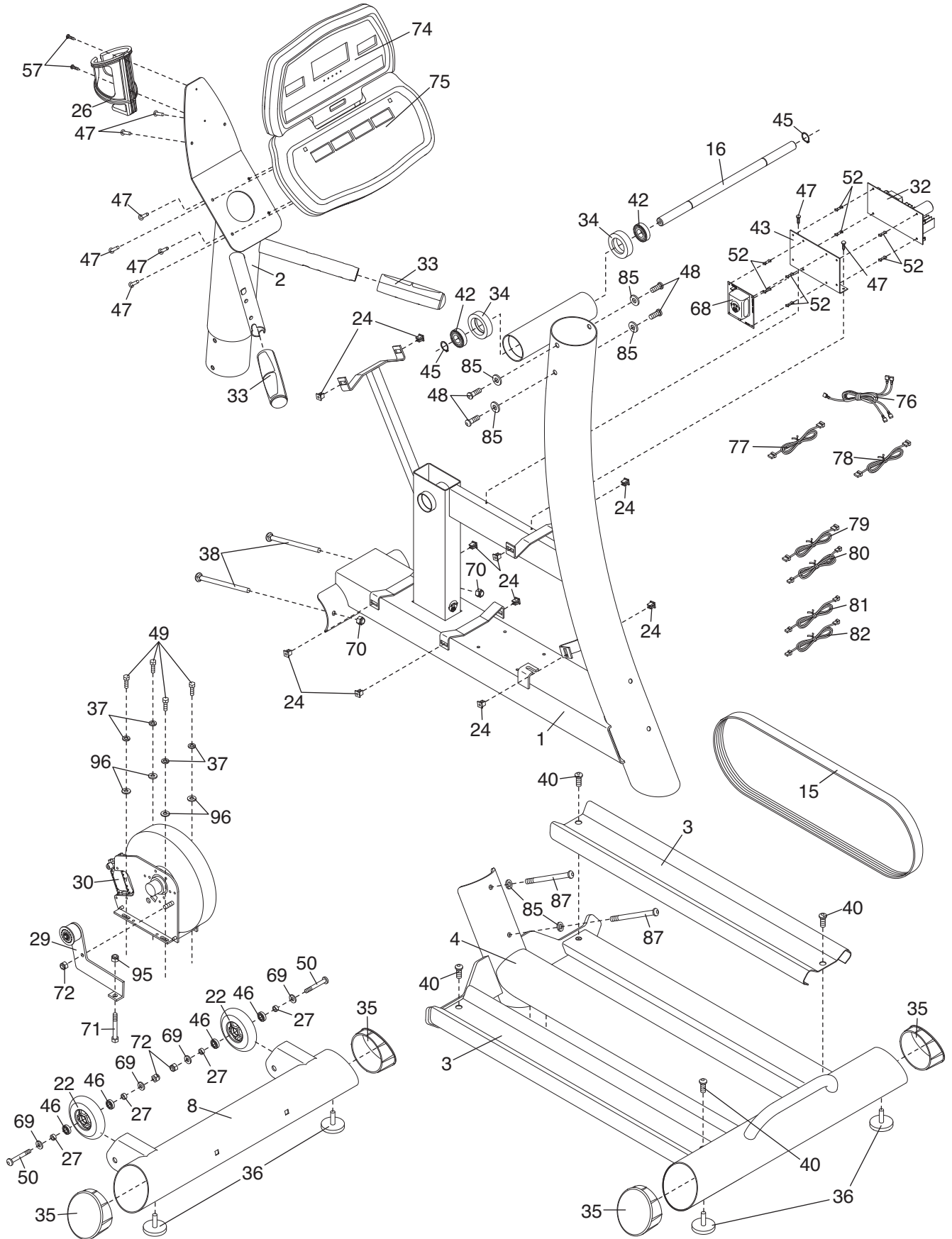

EXPLODED DRAWING B—Model No. 831.23912.0

R0509A

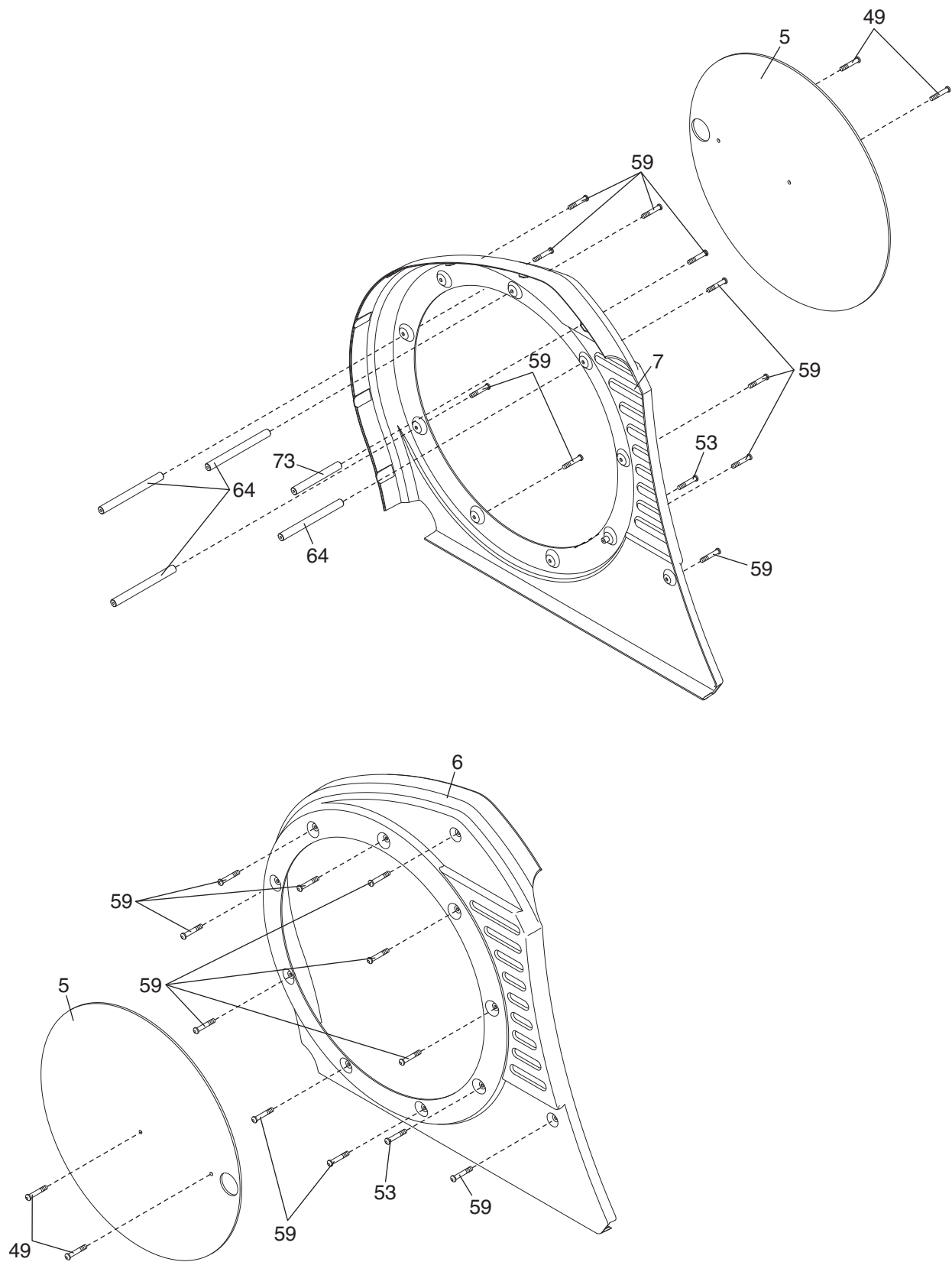

EXPLODED DRAWING C—Model No. 831.23912.0

R0509A

