

EXPLODED DRAWING A

Model No. 831.23940.0 R0914A

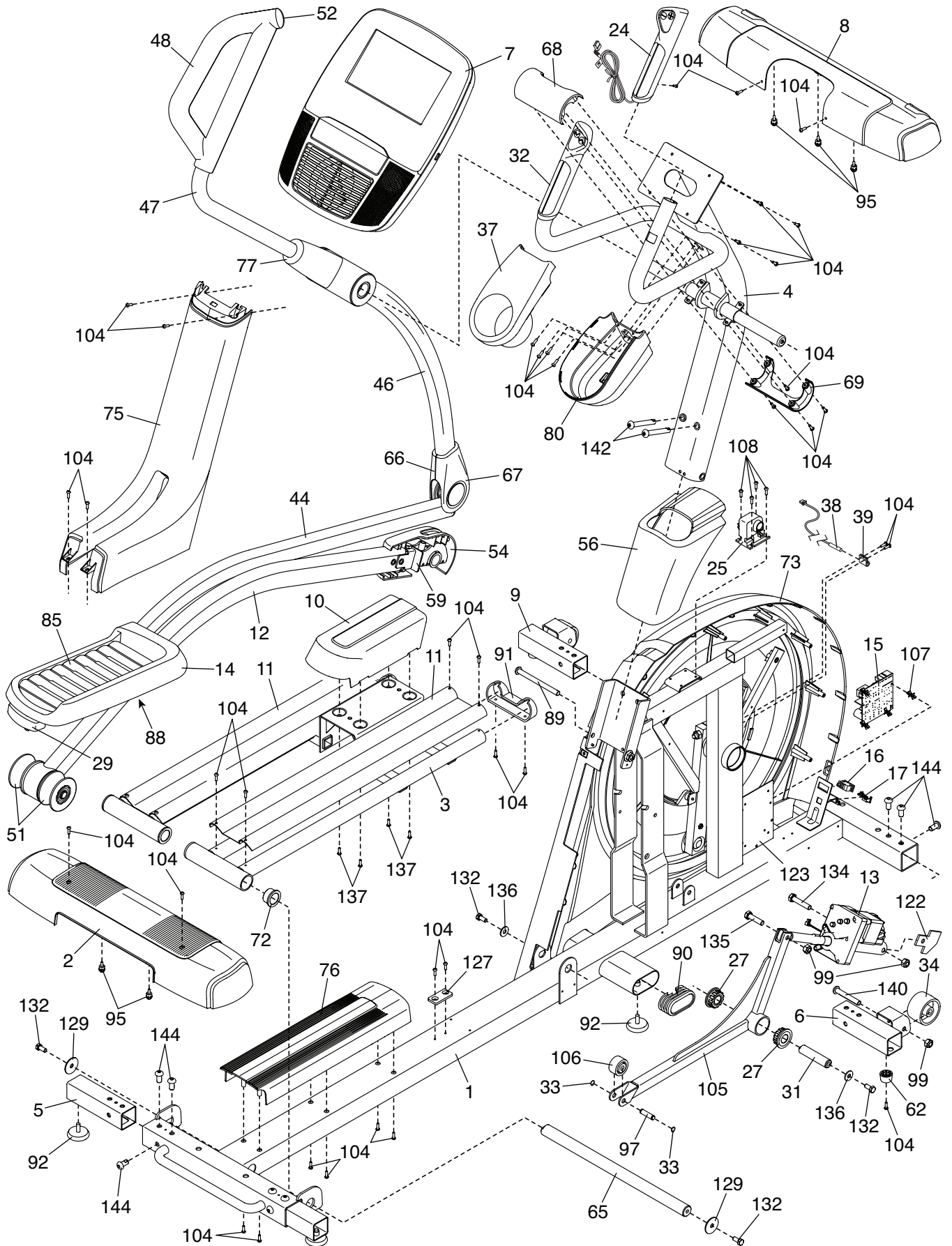

EXPLODED DRAWING B

Model No. 831.23940.0 R0914A

