

EXPLODED DRAWING A

Model No. 831.23946.0 R0913A

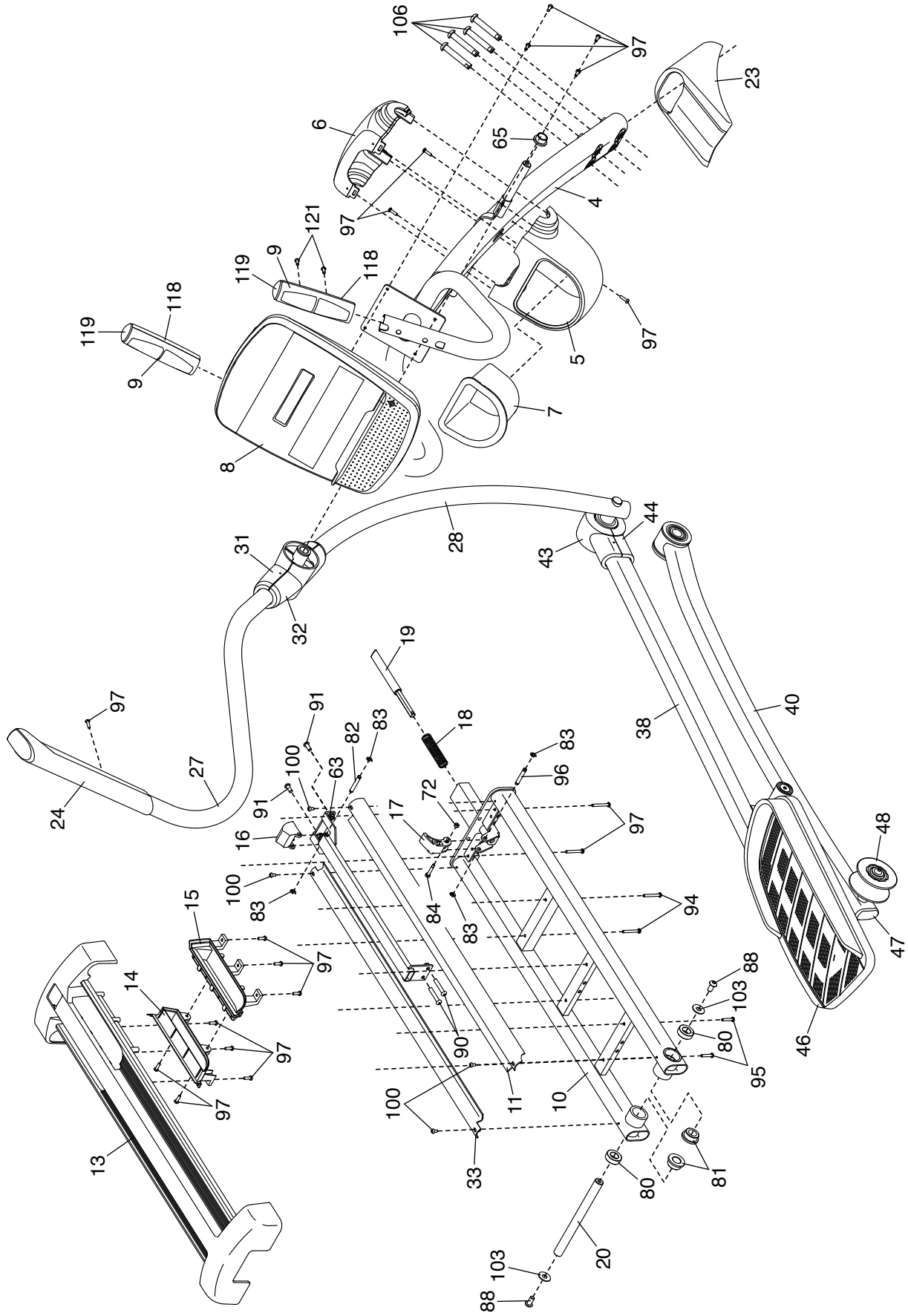

EXPLODED DRAWING B

Model No. 831.23946.0 R0913A

